



# XXL Rohrsysteme Piping Systems

EXZEPTIONELL IN  
DIMENSION UND QUALITÄT

EXCEPTIONAL IN  
DIMENSION AND QUALITY

 **agru**  
The Plastics Experts.

OUR  
PRODUCTS  
ARE AS  
MANIFOLD  
AS YOUR  
DEMANDS

# THE PLASTICS EXPERTS.

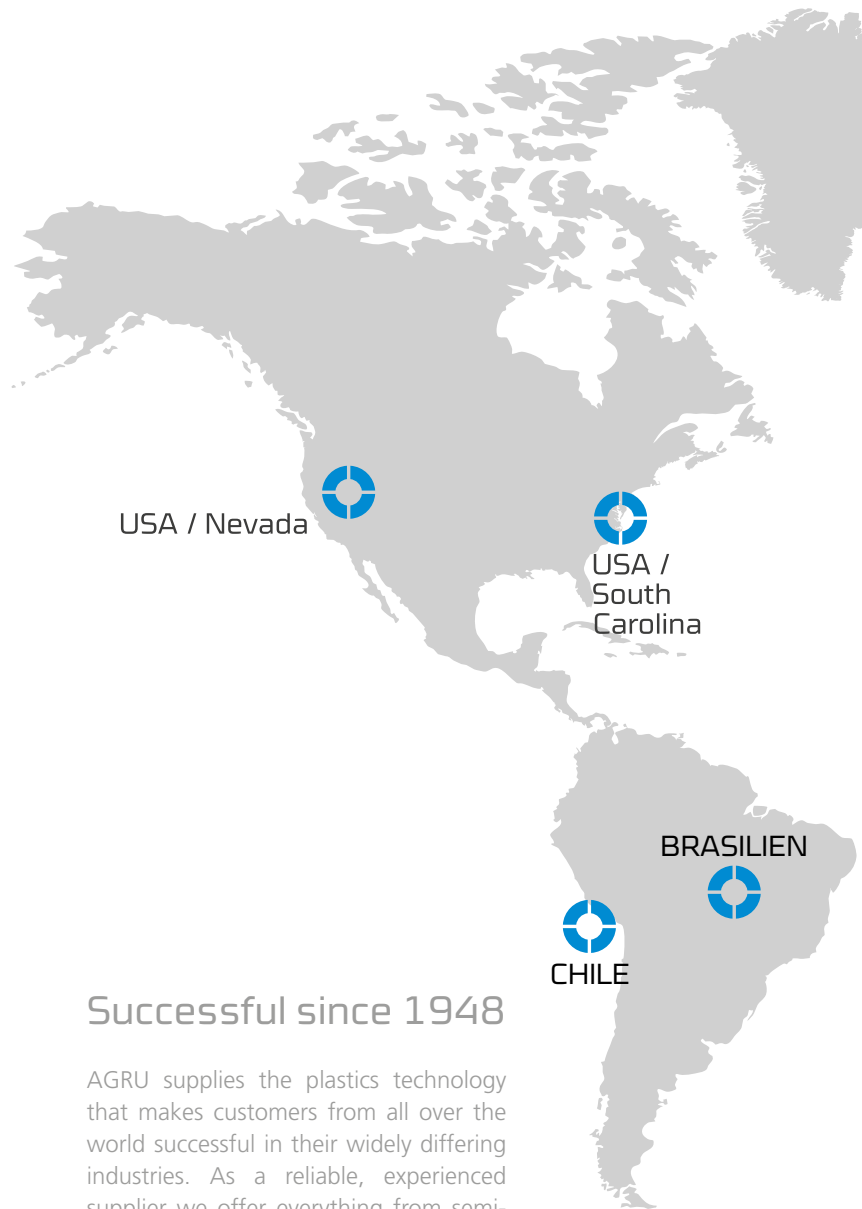

## Seit 1948 erfolgreich

AGRU liefert Kunststofftechnik, die Kunden aus unterschiedlichen Industriebereichen weltweit erfolgreich macht. Als zuverlässiger, erfahrener Lieferant bieten wir vom Halbzeug bis zum technologisch optimierten Spritzgussformteil alles aus einer Hand. Wir kennen die Herausforderungen aus tausenden Projekten und entwickeln unsere Produkte und Dienstleistungen laufend weiter. Kompromisslose Qualität, herausragender Kundennutzen und hohe Betriebssicherheit sind dabei unsere Maximen. Maßgeschneiderte Kundenlösungen und anwendungsorientierte Neuentwicklungen realisieren wir mit höchster Flexibilität - präzise und kostengünstig. Unsere engagierten Mitarbeiter mit Kunststoffkompetenz machen AGRU zu einem erfolgreichen Global Player.

Alles aus einer Hand anzubieten, unterscheidet uns von Vielen. Wir verarbeiten ausschließlich hochwertige, thermoplastische Kunststoffe. Und wenn es um Lösungskompetenz bei Materialauswahl und Verlegung geht, sind wir Ihr bester Ansprechpartner.

## Successful since 1948

AGRU supplies the plastics technology that makes customers from all over the world successful in their widely differing industries. As a reliable, experienced supplier we offer everything from semi-finished products through to technologically optimised injection mouldings, all from a single source. We handle the challenges from thousands of projects and evolve our products and services on a rolling basis. Uncompromising quality, outstanding customer benefit and high operational dependability are our maxims. We implement custom solutions and application-oriented new developments with the highest flexibility - with precision and economically. Our dedicated employees with plastics expertise make AGRU successful as a global player.

Our ability to supply everything from a single source sets us apart. We use only top-grade thermoplastic polymers as our raw materials. When it comes to application-technical consulting, we are your best partner in the field.

 AUSTRIA | GERMANY | POLAND

 CHINA

# AGRU PLANTS IN 7 COUNTRIES

**AGRU KUNSTSTOFFTECHNIK  
AUSTRIA**



**AGRU OBERFLÄCHENTECHNIK  
AUSTRIA**



**AGRU-FRANK  
GERMANY**



**TWS  
POLAND**



**AGRU NEVADA  
FERNLEY, NV/USA**



**AGRU AMERICA  
GEORGETOWN, SC/USA**



**AGRU AMERICA  
ANDREWS, SC/USA**



**XXL PIPE PRODUCTION FACILITY  
CHARLESTON, SC/USA**



**TAICANG AGRU PLASTICS  
CHINA**



**AGRU CHILE  
QUILICURA, SANTIAGO, CHILE**



**AGRU BRASIL  
BARUERI - SÃO PAULO - BRAZIL**



# PRODUCTS

## AGRUCEM INDUSTRIE INDUSTRIAL PIPING SYSTEMS



### ROHRSYSTEME / PIPING SYSTEMS

Rohr- und Doppelrohrsysteme aus PP, PEHD-el, PPs, PPs-el, PVDF und ECTFE für industrielle Anwendungen wie den Transport von aggressiven Medien und kontaminiertem Abwasser. Rohrsysteme aus PE 100 blau für diverse Druckluftanwendungen.

Piping systems and double containment piping systems made of PP, HDPE-el, PPs, PPs-el, PVDF and ECTFE for industrial applications such as transport of aggressive media and contaminated sewage water. Piping system made of PE 100 blue for various compressed air applications.

## AGRULINE



### ROHRSYSTEME / PIPING SYSTEMS

PE 100 Rohrsysteme für Gas- und Wasserversorgung sowie Abwasserentsorgung und PE 100-RC Rohrsysteme für grabenlose und sandbettfreie Verlegung erhältlich in Dimensionen bis zu  $d_a$  3500 mm.

PE 100 piping systems for gas and potable water distribution as well as sewage water disposal and PE 100-RC piping systems for trenchless and sandbed-free installation available in dimensions up to OD 3500 mm.

## PURAD



### ROHRSYSTEME / PIPING SYSTEMS

Rohrsysteme in PVDF-UHP, PP-Pure, Polypure und ECTFE für den Transport von hochreinen Medien der Halbleiter- und Pharmaindustrie sowie der Getränke- und Lebensmittelindustrie.

PVDF-UHP, PP-Pure, Polypure and ECTFE piping systems for the distribution of ultra-pure-water in semiconductor, pharmaceutical and food industry.

## Zulassungen / Certifications





## HALBZEUGE SEMI-FINISHED PRODUCTS



### HALBZEUGE / SEMI-FINISHED PRODUCTS

Rundstäbe, Blöcke, Linerrohre, Schweißdrähte, Platten und Formteile aus thermoplastischen Kunststoffen wie PP, PE, PPs, PPs-el, PEHD, PEHD-el, PVDF, ECTFE, FEP und PFA passend für den Apparate- und Behälterbau.

Sheets, bars, blocks, liner pipes welding rods and fittings made of PP, PE, PPs, PPs-el, HDPE, HDPE-el, PVDF, ECTFE, FEP and PFA for the manufacturing of tanks and for use in apparatus engineering.

## LINING SYSTEMS



### DICHTUNGSBAHNEN / GEOMEMBRANES

Dichtungsbahnen und Abdichtungen aus PEHD, PE-VLD, PE-LLD und FPP sowie Drainage Systeme aus PE und PP für Deponien, Tunnel und Teiche.

Geomembranes made of HDPE, VLDPE, LLDPE and FPP as well as drainage systems made of PE and PP for the use in landfills, tunnels, ponds, hydraulic engineering.

## BETONSCHUTZ CONCRETE PROTECTION



### BETONSCHUTZPLATTEN / CONCRETE PROTECTIVE LINERS

Betonschutzplatten und Profile aus PE, PP, PVDF und ECTFE sind der passende Schutz für Ihr Bauwerk gegen chemische Korrosion.

Concrete protective liners and assembly profiles made of PE, PP, PVDF and ECTFE for the protection of your concrete structures from wear and chemical corrosion.

## SCHWEISSEN WELDING



### SCHWEISSTECHNIK / WELDING SYSTEMS

Schweißmaschinen in verschiedensten Dimensionen für die professionelle Infrarot-, Stumpf-, Induktions- und Heizwendelschweißung.

Welding machines in various dimensions for professional infrared-, butt- and induction welding.



IGNiG





## Innovation sichert Erfolg

Forschung und Entwicklung haben einen sehr hohen Stellenwert im Unternehmen. Ziel der Forschung ist der absolute Kundennutzen im Sinne kontinuierlicher Verbesserung und neuer Marktanforderungen.

Die Mission erster zu sein.

Europas erster Produzent von Formteilen im Spritzguss. Die weltweit erste Kalandrierung von extrabreiten Dichtungsbahnen. AGRU setzt nun mit einem Reinraumwerk für Reinstmedien-Rohrsysteme neue Maßstäbe.

## Innovation - the key to success

AGRU's plastics engineers are focused on the future. Only those who today are dealing with the customer- and target-group-specific requirements of tomorrow will be successful in the future.

We claim to be the first.

Europe's first to produce fittings in injection moulds; the world's first to calender liners many meters wide. Once again the company has set new standards by building a clean-room plant for ultra-pure media piping systems.

**GROUND-BREAKING INNOVATIONS HAVE BEEN A HALLMARK OF AGRU SINCE ITS EARLIEST DAYS.**

## Qualität

Kompromisslose Qualität, herausragender Kundennutzen und hohe Betriebssicherheit sind unsere Maximen. In mehr als 50 Jahren hat AGRU einen Pool an Fachwissen aufgebaut, das in der Branche einmalig ist. Diese „Lebenserfahrung“ fließt in anwendungsorientierte Innovation, hochtechnologische Produktion sowie herausragende Service- und Logistikleistungen ein.

Wir sind stolz auf viele nationale und internationale Zertifikate, Zulassungen und unser nach ISO 9001:2015 zertifiziertes Qualitätssystem – im Sinne unserer Kunden für weltweiten Einsatz.

## Quality

Operational reliability, on-time delivery and maximum customer benefit are our maxims. Over more than 50 years, the plastics experts have accumulated a wealth of expertise unique in the industry. This lifetime of experience flows into application-oriented innovation, high-tech production and outstanding service and logistics performance.

We are proud of our numerous national and international certificates, approvals and certified quality system ISO 9001:2015 – for our customers and for worldwide application.

AGRU  
IS KNOWN  
FOR ITS HIGH  
QUALITY  
STANDARDS  
AROUND THE  
WORLD





# AGRU - A TRUSTED PARTNER

## Zuverlässigkeit

Unterschiedliche Werkstoffe, Technologien und Produkte sowie ein weltumspannendes Partnernetzwerk machen AGRU zum zuverlässigen Komplettanbieter. Vor allem für Großprojekte und Sonderlösungen bietet AGRU damit seinen Kunden einen One-Stop-Shop. AGRU ist ein Synonym für Kundennutzen und dafür bekannt, die Kundenwünsche effizient, kostengünstig und mit höchster Flexibilität zu erfüllen. Maßgeschneiderte, kundenorientierte technische Lösungen, „Out-of-the-box-Denken“ und jahrzehntelange Kunststoffverarbeitung sind dafür notwendig.

## Reliability

Different materials, technologies and products plus a worldwide network of partners all contribute to making AGRU a single-source supplier. For large-scale projects and special solutions in particular, AGRU is able to offer its customers a one-stop shop. AGRU has built a reputation for satisfying its customers' wishes efficiently, cost-effectively and with superlative flexibility. Customer-oriented technical solutions, the ability to think outside the box and decades of hands-on experience are what it takes.





# MAXIMUM CUSTOMER BENEFIT

## Service

Die Wirtschaftlichkeit einer technischen Lösung entscheidet sich oft beim eingesetzten Werkstoff. Nur wenn das Ausgangsmaterial perfekt an die Einsatzbedingungen angepasst ist, können Chemikalien- und Temperaturbeständigkeit sowie die physische Belastbarkeit voll erfüllt werden. Die anwendungsspezifische Materialauswahl ist eine Kernkompetenz von AGRU. Als professioneller Ansprechpartner rund ums Thema Kunststoff zeigt AGRU die wirtschaftlichste Lösung für jede noch so große Herausforderung auf.

## Service

Very often, the material used turns out to be definitive in terms of the ultimate profitability of an engineering solution. Only if the raw material is perfectly matched to the real-world conditions of use can physical toughness and resistance to chemicals and temperature effects be fully specified. Application-specific material selection is one of AGRU's core competences. As a professional partner for everything associated with plastics, AGRU can point out the most economical solution for any problem, no matter how big the challenge.





## Technologieführerschaft

Am Stand der Technik zu produzieren, Prozesse zu verbessern und die Ergebnisse zu optimieren, ist bei AGRU der Garant für Wettbewerbsfähigkeit. In unseren Werken rund um den Globus beweisen wir Tag für Tag Kosten- und Qualitätsführerschaft. Der technologische Vorsprung bewirkt, dass AGRU-Lösungen stets zu den besten ihrer Branche zählen.

## Technology leadership

Producing at the cutting edge of technology, improving processes and optimising results are part and parcel of AGRU's guarantee of competitiveness. Day in, day out, we demonstrate our cost and quality leadership in our plants all over the globe. The technological edge means that AGRU solutions are consistently among the best in their field.



# XXL INSTALLATION

## XXL Rohrsystem Kosten- und zeitsparend in Installation und Betrieb

Aus PE 100 oder PE 100-RC gefertigt, ist das AGRULINE XXL Rohrsystem die wirtschaftlichste Lösung für Anwendungen mit hohen Volumenströmen. Konstant bleibende, ausgezeichnete Fließeigenschaften sorgen für reduzierte Betriebskosten. Die hohe Korrosions- und UV Beständigkeit machen das robuste System zudem wartungsfrei. Zusammen mit der langjährig bewährten Installationstechnik ist dies zu Wasser und zu Land die beste Lösung für große Anforderungen.

## XXL piping system Cost and time saving installation and operation

Made made of PE 100 or PE 100-RC, the AGRULINE XXL piping system offers the most economic solution when it comes to high volume flow applications. The excellent long term hydraulic properties reduces operating costs. The high corrosion-, wear-, tear- and UV resistance makes the system maintenance-free. Together with the long-term proven installation technology, this is the perfect system both on- and offshore.





## Überragende Lebensdauer

### Polyethylen rostet nicht

Weniger Betriebskosten im Vergleich zu Alternativlösungen

- basierend auf der hohen Resistenz gegenüber Korrosion, Abrasion und UV-Strahlung
- reduzierter Algenbewuchs und weniger Inkrustation durch glatte Innenflächen
- nachweislich wartungsfreier Betrieb

## Schnelle und einfache Installation

### Polyethylen ist flexibel, leichtgewichtig und einfach verschweißbar

Herausragende Eigenschaften von PE-Rohren

- umfassendes Programm an Rohren und Formteilen verfügbar
- verschiedenste Verlegemethoden möglich
- zeitsparende Stumpfschweißung sorgt für hohe Lebensdauer und Dichtheit
- die hohe Dauerfestigkeit verhindert Schäden während der Installation und im Betrieb
- schnelles und sicheres Absenken im Meer

## Für Höchstleistungen entwickelt

**Rohre zwischen  $d_a$  20 mm und  $d_a$  3500 mm sind in den Druckklassen von SDR 41 bis SDR 7,4 verfügbar**

Für Hochleistungseinsätze geeignet

- das perfekte System für Kraftwerke mit hohem Kühlwasserbedarf
- resistent gegenüber Wasserschlägen und Druckstößen
- breites Anwendungsspektrum (Kühlwasser, Meerwasserentsalzung, Abwasser, Bergbau, Bewässerung...)

## Outstanding life span

### polyethylene never corrodes

Less operating costs compared to other solutions

- based on a high resistance to corrosion, abrasion and UV radiation
- long lasting smooth internal surface reduces biological growth / incrustations
- proofed maintenance-free operation

## Fast and easy installation

### polyethylene is flexible, lightweight and easy to weld

Superior laying properties

- due to an extensive range of pipe diameters and fittings
- allowing various installation methods
- time saving butt welding provides durability and leak tightness
- a high fatigue strength prevents damages during installation & operation
- fast & safe sinking processes at offshore installation

## Heavy-duty dimensioned

**pipes available between OD 20 mm and OD 3500 mm from SDR 41 up to SDR 7,4 (for larger pipe sizes up to SDR 17)**

Designed for highest demands

- perfect for power plants with large required quantities of cooling water
- withstands water hammers and pressure surges
- wide application range (cooling, desalination, sewage, mining, irrigation,..)



# XXL PIPING SYSTEMS

## Die glatten Rohrinneflächen

- reduzieren Algenbewuchs und Inkrustation
- sind korrosionsfrei
- sind besonders abrasionsbeständig
- bieten dauerhaft ausgezeichnete Fließeigenschaften
- minimieren Druckverluste nachhaltig
- reduzieren die Stromkosten für Pumpen
- zeichnen sich durch hohe chemische Beständigkeit aus

## Hohe Dauerfestigkeit

- nachweislich gute Resistenz gegenüber statischer und seismischer Belastung (Erdbeben und Bodensetzungen)
- sichere und einfache Handhabung im Vergleich zu anderen Materialien
- resistent gegenüber Wasserschlägen und Druckstößen (bis 200 % des MOP)
- leichte Richtungsänderungen ohne Formteile möglich

## XXL Rohre

- sind leichtgewichtig trotz ihrer Größe im Vergleich zu anderen Materialien und reduzieren so Transport- und Installationskosten
- können aufgrund ihrer geringen Ovalität und einheitlichen Wandstärken einfach verlegt werden
- sind für Hochleistungseinsätze am Land und im Wasser konzipiert
- sind einfach die wirtschaftlichere Lösung wenn es um hohe Volumenströme geht

## Smooth internal pipe surface

- reduce biological growth and incrustations
- corrosion resistant
- provides high abrasion resistance
- offers the best long-term hydraulic properties
- permanent low head loss
- results in lower pumping costs
- provides excellent chemical resistance

## High fatigue strength

- proven good resistance to seismic forces (earthquakes and soil settlements)
- safer and easier handling compared to other materials
- withstands water hammers and pressure surges (up to 200 % of MOP)
- slight changes without elbows

## XXL pipes

- are lightweight despite their enormous size compared to other materials, cutting down transport and installation costs on-site
- feature a high roundness and uniform wall thickness for hassle-free installation
- are equally suitable for heavy-duty on- and offshore applications
- are simply the most economic solution for high volume flow applications



# SUPPLY RANGE - PIPES

## PE 100 (-RC) Rohre

AGRULINE XXL Rohre werden bis  $d_a$  3500 mm und einer Wandstärke von bis zu 150 mm produziert. Für Spezialprojekte können die Wandstärke und die Länge (max. 610 m) maßgeschneidert an die Projektanforderungen angepasst werden.

## PE 100 (-RC) pipe

AGRULINE XXL pipes can be produced up to a diameter of 3500 mm with a wall thickness up to 150 mm. For special projects the wall thickness and the length (max. 610 m / 2001 FT) of the pipe can be tailor-made to provide the optimal solution for the clients at reduced costs.

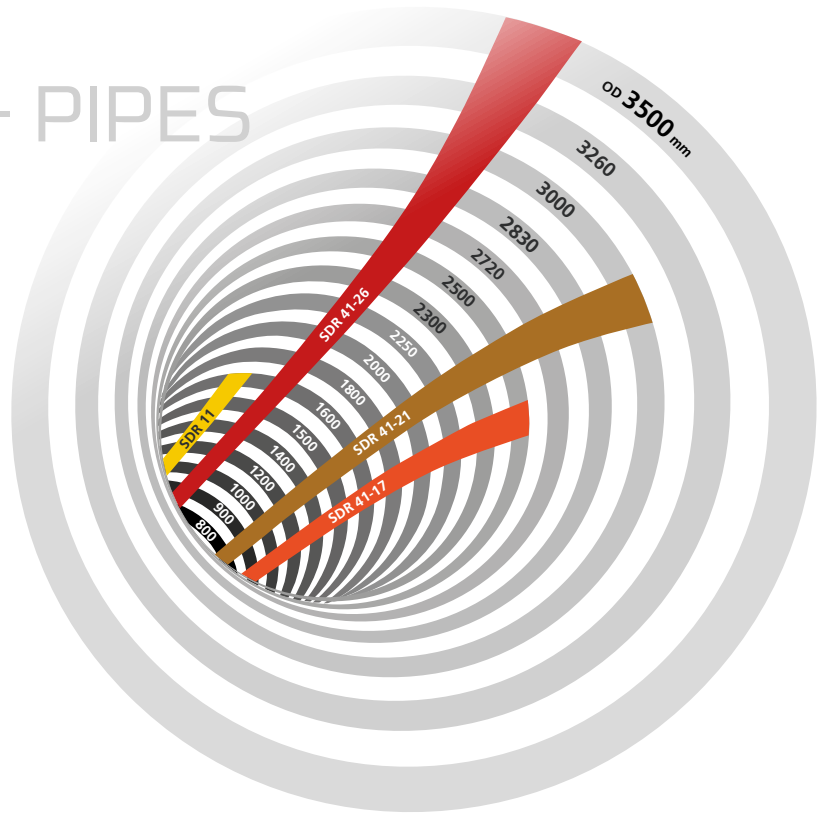

SDR	Max. Betriebsdruck (bar) max. working pressure (bar)
41	4
33	5
26	6.3
21	8
17	10
11	16

Weitere Druckklassen sind auf Anfrage verfügbar  
Further pressure ratings are available on request.

Annahme 20° C / 50 Jahre, Sicherheitsfaktor c = 1.25, Wasser (laut EN 12201)  
Applicable for 20° C / 50 years, safety factor c = 1.25, water (according to EN 12201)

## Rohrstränge

Verschiedene Rohrlängen sind für den Transport im Container, offenen Sattelzug oder per Schiff möglich. Von unserem Werk in Charleston, Amerika sind Rohrstränge bis zu 610 m Länge lieferbar. Je nach Dimension und Länge können mehrere Rohrstränge gleichzeitig mit dem Schiff zum Installationsort transportiert werden.

## Long pipe strings

Various pipe lengths for transport with container or ship are available. From our factory in Charleston, America pipe strings up to 610 m (2001 FT) length are available. Depending on dimension and length, several long string pipes can be delivered simultaneously with the ship to the installation site.



# SUPPLY RANGE - FITTINGS

## PE 100 (-RC) Formteile

AGRU fertigt voll druckbeständige Formteile aus Hohl- und Rundstäben. Zusätzlich können segmentierte Formteile, wie z.B. Bögen und T-Stücke, auf Kundenwunsch druckbeständig realisiert werden.

## PE 100 (-RC) fittings

AGRU manufactures full pressure resistant fittings out of round- and hollow bars. Furthermore fittings, segmented out of pipes like bends and tees can be provided.



Bend 11°, 22°, 30°, 45°, 60°, 90°	Tee	Reduced Tee	Stub Flange	Reduction	End Cap	Toploadsaddle
OD [mm]	OD [mm]	OD [mm]	OD [mm]	OD [mm]	OD [mm]	OD / branch Ø [mm]
800	800	800 / ≤700	800	800/630/800/710	800	800 / ≤500
900	900	900 / ≤800	900	900/710/900/800	900	900 / ≤500
1000	1000	1000 / ≤900	1000	1000/900	1000	1000 / ≤500
1200	1200	1200 / ≤1000	1200	1200/1000	1200	1200 / ≤500
1400	1400	1400 / ≤1200	1400	1400/1200		1400 / ≤500
1500	1500	1500 / ≤1200	1500	1500/1200		1500 / ≤500
1600	1600	1600 / ≤1400	1600	1600/1400		1600 / ≤900
1800	1800	1800 / ≤1600	1800	1800/1600		1800 / ≤900
2000	2000	2000 / ≤1800	2000	2000/1800		2000 / ≤1400
2250	2250	2250 / ≤2000	2250	2250/2000		2250 / ≤1400
2300	2300	2300 / ≤2000	2300	2300/2000		2300 / ≤1400
2500		2500 / ≤2250	2500	2500/2250		2500 / ≤1400
2720			2720			2720 / ≤1400
2830			2830			2830 / ≤1400
3000			3000			3000 / ≤1400
3260			3260			3260 / ≤1400
3500			3500			3500 / ≤1400





## Stutzenschelle System Topload

AGRU bietet das mechanisch gefertigte Stutzenschelle System "Topload" für XXL Rohre an. Das speziell entwickelte Spannsystem stellt die wirtschaftliche Installation von Abzweigungen auf beengtem Raum sicher. Die Vorteile:

- Höchste Sicherheit durch eingebettete Heizwendel
- Absolut robustes Design
- Abgangs-Stutzen können mittels Stumpf- oder Heizwendelschweißung verbunden werden
- Einfaches Aufspannen des Toploadsattels für die Heizwendelschweißung
- Stutzen kann in jeder Position und Richtung am Hauptrohr befestigt werden

## Spigot saddle system topload

AGRU offers machined spigot saddles system "Topload" for XXL pipes. The specially developed clamping system ensures a cost effective installation suitable for tight space configurations. They feature:

- Fully embedded heating wire
- Absolutely robust design
- Spigot connection by butt or electro-socket welding
- Easy mounting for specially developed clamping device
- Spigot adjustable in any position on the main pipe

### LIEFERPROGRAMM CODE 289 SUPPLY RANGE CODE 289

#### Dimensionen STS 355-3260 Dimensions STS 355-3260

Rohrdimensionen [mm] Dimension main [mm]	Stutzendimensionen [mm] Dimension spigot [mm]
355 - 1400	63, 90, 110, 125, 160, 180, 200, 225
450 - 1400	250, 280
450 - 2500	315
710 - 2500	355, 400, 450, 500
1600 - 3500	560, 630, 710, 800, 900, 1000, 1200, 1400

Spezialdimensionen können auf Anfrage hergestellt werden. Special dimensions not listed are available on request.

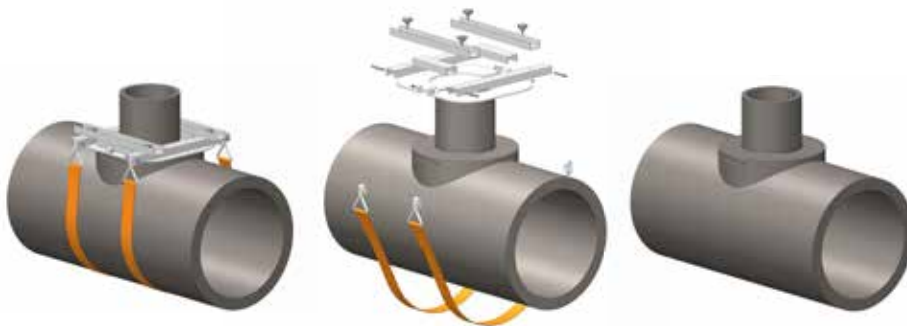

# PREFABRICATED PARTS FOR COOLING PIPELINES

## Ansaugköpfe

Der Ansaugkopf ist am Beginn einer Rohrleitung installiert, die Wasser aus dem Meer, See oder Fluss zu einer Pumpstation befördert. Dieser Spezialformteil verhindert das Einsaugen von marinen Lebensformen und größeren Objekten. AGRU bietet dafür verschiedene Lösungen in PE an.

## Intake heads

An intake head is fixed on a pipeline which transports water from the source (e.g sea, lake, river) to a chamber or directly to a pumping station. This special fitting prevents the intake of marine life forms and larger objects. AGRU can provide various solutions adopted for the project in PE.



## Stutzenschelle System Topload als Pumpenverteiler

Diese Sonderkonstruktion dient als Übergangsstück vom Kühlwassersammelbecken zum Rohrsystem. Dabei wird über Pumpen, die mittels Stutzenschellen System Topload an die Hauptleitung angeschlossen sind, das Kühlwasser aus dem Sammelbecken zu den Kühltürmen geleitet. Diese 18 m lange, maßgeschneiderte Lösung mit einem Sammelrohr  $d_a$  2000 mm und Stutzenschellen System Topload  $d_a$  1200 mm wurde von den AGRU Kunststofftechnikern in SDR 21 ausgeführt.



## Spigot saddle system topload as pump station

This special design is used as an adaptor from the cooling water basin to the piping system. The pumps are directly connected to the main line by spigot saddles system topload and distributing the cooling water directly to the cooling towers. This 18 m long, tailor-made solution with a collecting tube OD 2000 mm and a spigot saddle system topload OD 1200 mm was executed by the AGRU plastic experts in SDR 21.

## Stutzenschelle System Topload als Diffusor

Das erhitzte Kühlwasser von kalorischen und nuklearen Kraftwerken muss über groß dimensionierte Auslaufleitungen zur Schonung der Lebewesen wieder behutsam an das Gewässer abgegeben werden. Stutzenschellen Topload dienen dabei als Diffusoren und sorgen für eine gleichmäßige Strömungsverteilung und schonende Vermischung von See- oder Meerwasser.

## Spigot saddle system topload as diffusor

The heated cooling water from caloric and nuclear power plants must be carefully returned to the sea by means of large-dimensioned sea outfall lines to protect the marine life. Topload saddles serve as diffusers to ensure an even flow distribution and gentle mixing of hot and sea water.





# XXL PIPES APPLICATIONS

## Maritimeinstallation

Das AGRULINE XXL Rohrsystem ist die erste Wahl, wenn es um Installationen auf offener See geht. Die Rohre werden per Schiff zum Einsatzgebiet gezogen, da sie im Wasser schwimmen. Nach dem Platzieren auf der Meeresoberfläche am Installationsort werden diese punktgenau zum Meeresgrund abgesenkt. Aufgrund der überragenden Flexibilität von PE 100 Rohren passen sie sich perfekt an den Meeresuntergrund an.

AGRU bietet ein komplettes, dauerhaft wartungsfreies System für Meeresinstallationen bestehend aus Rohr, Formteilen und Spezialbauteilen wie Ansaugköpfen und Diffusoren. Rohrleitungen zur Chlorierung des eingesaugten Meerwassers sind ebenso verfügbar, wobei unterschiedlichste Materialien (PE 100-RC, ECTFE) zur Wahl stehen.

## Offshore installation

The AGRULINE XXL piping system is the first choice for offshore installations. Pipes can be towed to the installation site because of their buoyancy in water. Later, the safe and fast sinking process allows lowering the pipeline to the seabed in a flash, utilizing the PE pipe flexibility.

In conjunction with the PE intake head and diffuser solutions AGRU provides a complete system for durable offshore pipe installation. Chlorination piping solutions designed for the transported chlorination media are also offered whereby various piping materials (PE 100 RC, ECTFE) are available.

## Kühlwasser Ansaugleitung

Eine Kühlwasser Ansaugleitung muss so konzipiert und gebaut sein, dass eine ausreichende Wasserzuführung hinsichtlich der Menge und Qualität für den Endverbraucher (z. B. Kraftwerke, Entsalzungsanlagen, Minen) gewährleistet ist. Solche Ansaugleitungen sind ein wesentlicher Bestandteil für das Komplettsystem und müssen mit großer Sorgfalt entworfen werden.

## Installation zu Land

Die hohe Strapazierfestigkeit und die einfachen Verbindungsmethoden erlauben die schnelle und sichere Verlegung der AGRULINE XXL Rohre. Geringeres Materialgewicht verglichen zu anderen Systemen führt zu einer einfacheren und flexibleren Verlegung. Vorausgehend sind auch die Transportkosten der Komponenten niedriger. Stumpfschweißarbeiten können außerhalb des beengten Grabens erfolgen. Bis  $d_a$  1400 mm sind auch Heizwendelformteile als Verbindungselemente lieferbar.

## Sanierung

Alternative Methoden zur Sanierung bestehender Leitungen sind das Sliplining-, Swagelining- und Sublining-Verfahren mit PE-Rohren von AGRU. Diese bewährten, kostensparenden Sanierungsmethoden erlauben die Erstellung von neuen Rohrstrukturen ohne Service- und Verkehrsbeeinträchtigungen oder Sachbeschädigungen zu verursachen, wie sie durch Grabarbeiten bei herkömmlicher Verlegung auftreten.

## Seawater intake pipe system

A seawater intake system has to be designed and constructed to ensure a sufficient water supply regarding the quantity and quality for the complete system (e.g. power stations, desalination plants, mines). Such seawater intake systems are a fundamental part for the system and thus have to be designed with great care.

## Onshore installation

The wear and tear resistance and easy joining methods make the installation fast and safe. Lower material weight compared to other systems leads to an easier and more flexible installation. Due to this fact, also transport costs can be reduced. Pipe joining can be done outside and inside the trench. Up to OD 1400mm also EF-couplers for tie in joints are available.

## Relining

Alternate methods for restoration of existing pipelines are sliplining, swagelining and sublining with AGRU PE pipes. This is a proven cost-effective method that provides a new pipe structure with minimum disruption of service, surface traffic, or property damage that would be caused by extensive excavation.







# MAXIMUM CUSTOMER BENEFIT

## Horizontales Spülbohrverfahren

Durch die hohe Flexibilität von PE Rohren können Spülbohrungen auch mit geringen Verlegeradien ausgeführt werden. Mögliche Bodensetzungen werden durch zulässige Verformungen der Rohre aufgenommen, ohne dass Schäden in Folge von Rissen oder Brüchen zu befürchten sind. AGRULINE-Rohre aus PE 100-RC erfüllen alle Anforderungen und sind für grabenlose Verlegetechniken gemäß der PAS 1075 geprüft und zugelassen.

## Horizontal directional drilling

Due to the high flexibility of PE pipes, horizontal directional drilling can also be carried out with tight installation radii. Possible soil settlements are absorbed by permissible deformations of the pipes without fear of damage due to cracks or fractures. AGRULINE pipes made of PE 100-RC meet all requirements and are tested and approved for trenchless laying techniques according to the PAS 1075.



**ISO  
9001**

Quality management system



**ISO  
14001**

Quality management system



**ISO  
45001**

Occupational health and safety



**EN  
12201**

Plastic piping systems for water supply



**ISO  
4427**

Plastic piping systems for water supply





<b>A</b>	<b>Material properties</b>	73
<b>B</b>	<b>Calculation guide</b>	83
<b>C</b>	<b>Heated tool butt welding</b>	97
<b>D</b>	<b>Installation guide</b>	103
<b>E</b>	<b>Marine Installation</b>	113

Marine Installation	Installation guide	Heated tool butt welding	Calculation guide	Material properties

<b>1</b>	<b>General properties</b>	75
<b>2</b>	<b>Material-specific properties</b>	76
<b>3</b>	<b>Nominal stiffness</b>	80
<b>4</b>	<b>Resistance of polyethylene</b>	81

Marine Installation	Installation guide	Heated tool butt welding	Calculation guide	Material properties

## 1 General properties

### 1.1 Polyethylene (PE)

As a result of the continuous development of PE resins, the efficiency of PE pipes and fittings has been improved significantly. Due to that fact new international standards (ISO 9080, EN 1555, EN 12201) were introduced, which lead to higher permissible operating pressures.

Polyethylene for pipes and fittings is no longer classified by its density (e.g. PE-LD, PE-MD, PE-HD) but it is now divided into MRS-classes (MRS = minimum required strength).

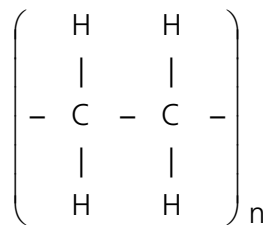

Figure A.1: Chemical structure of polyethylene.

#### 1.1.1 Advantages of PE

- High flexibility
- Weldable
- Low weight
- Convenient transportation (e.g. coiled bundles)
- UV resistance (with carbon black)
- Excellent chemical resistance
- Excellent weather-resistance
- Excellent radiation resistance
- Excellent abrasion resistance
- Minimal deposits and no ingrowth possible due to lower frictional resistance
- Lower pressure losses in comparison to e.g. metals
- Resistant against pressure surges (up to 200% of the MOP)
- Application at lower temperatures
- Resistant to rodents
- Low microbial growth
- Physiologically safe

### 1.2 PE 100 polyethylene type

These materials are also known as polyethylene types of the third generation (Minimum Required Strength MRS=10 MPa).

PE 100 materials are advanced type PE-HD materials which show an altered, bimodal molecular weight distribution due to a modified polymerisation process. Because of that PE 100 types have a higher density and improved mechanical properties such as stiffness or hardness. The creep strength and the resistance against rapid crack propagation are increased significantly.

Therefore, PE 100 is suitable for the production of large diameter pressure pipes. These can achieve the same pressure rating with smaller wall thickness compared to conventional pressure pipes made of PE-HD (PE80).

### 1.3 PE 100-RC polyethylene type

Regarding the pressure resistance and the processability there are no differences between PE 100-RC materials and PE 100 materials.

The primary difference, compared to the standard PE 100 materials, is the high resistance against the slow crack growth. This property allows a safe sandbed-free installation as well as a use of alternative installation technologies for underground piping systems.

During a sandbed-free installation the excavated material (soil, gravel, ballast) can be reused for the filling if it is compressible acc. to the current standards.

Guideline for the grain size of the excavated material (source: ÖVGW/GRIS PW 405/1):

DIM OD <63 mm	up to 22 mm grain size
DIM OD >63 mm	up to 100 mm grain size

PE 100-RC therefore provides extended protection against:

- point loads,
- crack initiation,
- slow crack growth (SCG).



## 2 Material-specific properties

### 2.1 PE 100 and PE 100-RC

#### 2.1.1 Material properties

The values mentioned are **guidelines** for the particular material.

	Properties	Standard	Unit	PE 100	PE 100-RC
mechanical / physical	MRS Classification	ISO 9080	N/mm <sup>2</sup>	10	10
	Specific density at 23 °C	ISO 1183	g/cm <sup>3</sup>	0.96 <sup>2)</sup>	0.96 <sup>2)</sup>
	Melt flow rate (MFR 190/5)	ISO 1133-1	g/10min	~0.3 <sup>1)</sup>	~0.3 <sup>1)</sup>
	MFI range			T003	T003
	Tensile stress at yield	ISO 527	MPa	≥23	≥23
	Elongation at yield	ISO 527	%	≥9	≥9
	Elongation at break	ISO 527	%	>350 <sup>2)</sup>	≥350 <sup>2)</sup>
	Impact strength unnotched (at -30 °C)	ISO 179	kJ/m <sup>2</sup>	no break	no break
	Impact strength notched (at +23 °C)	ISO 179	kJ/m <sup>2</sup>	≥13 <sup>3)</sup>	≥13 <sup>3)</sup>
	Impact strength notched (at -30 °C)	ISO 179	kJ/m <sup>2</sup>	10	10
	Shore-D hardness (3 sec)	ISO 868	1	~60	~60
	Flexural strength (3.5 % flexural stress)	ISO 178	MPa	≥21	≥21
	Young's Modulus	ISO 527	MPa	≥1000	≥1000
	Stress cracking resistance (FNCT)	ISO 16770 EN 12814-3	h	≥300 <sup>3)</sup>	≥8760 <sup>3)</sup>
thermal	Heat deflection temperature HDT/B	ISO 75	°C	75	75
	Linear coefficient of thermal expansion	DIN 53752	K <sup>-1</sup> × 10 <sup>-4</sup>	1.8 <sup>4)</sup>	1.8 <sup>4)</sup>
	Thermal conductivity (at 20 °C)	DIN 52612	W / (m×K)	~0.4	~0.4
	Flammability	UL 94	-	94-HB	94-HB
		DIN 4102	-	B2	B2
Application temperature	-	°C	-40 to +60 *		
electric	Volume resistivity	VDE 0303	Ω × cm	>10 <sup>16</sup>	>10 <sup>16</sup>
	Surface resistivity	VDE 0303	Ω	>10 <sup>13</sup>	>10 <sup>13</sup>
	Dielectric coefficient at 1 MHz	DIN 53483	-	2.3	2.3
	Electric strength	VDE 0303	kV/mm	70	70
general	Physiologically inert	EEC 90/128	-	yes	yes
	UV stabiliser	-	-	carbon black	
	Color	-	-	black	black

Table A.1: Specific material properties of PE 100 and PE 100-RC

Guidelines from:

1) DVS 2207-1 2) EN 12201 3) DVS 2205-1 suppl.1 4) DVS 2210-1

\* depending on the application area and operating time (see chapter 2.1.3)

## 2.1.2 Hydrostatic long-term strength

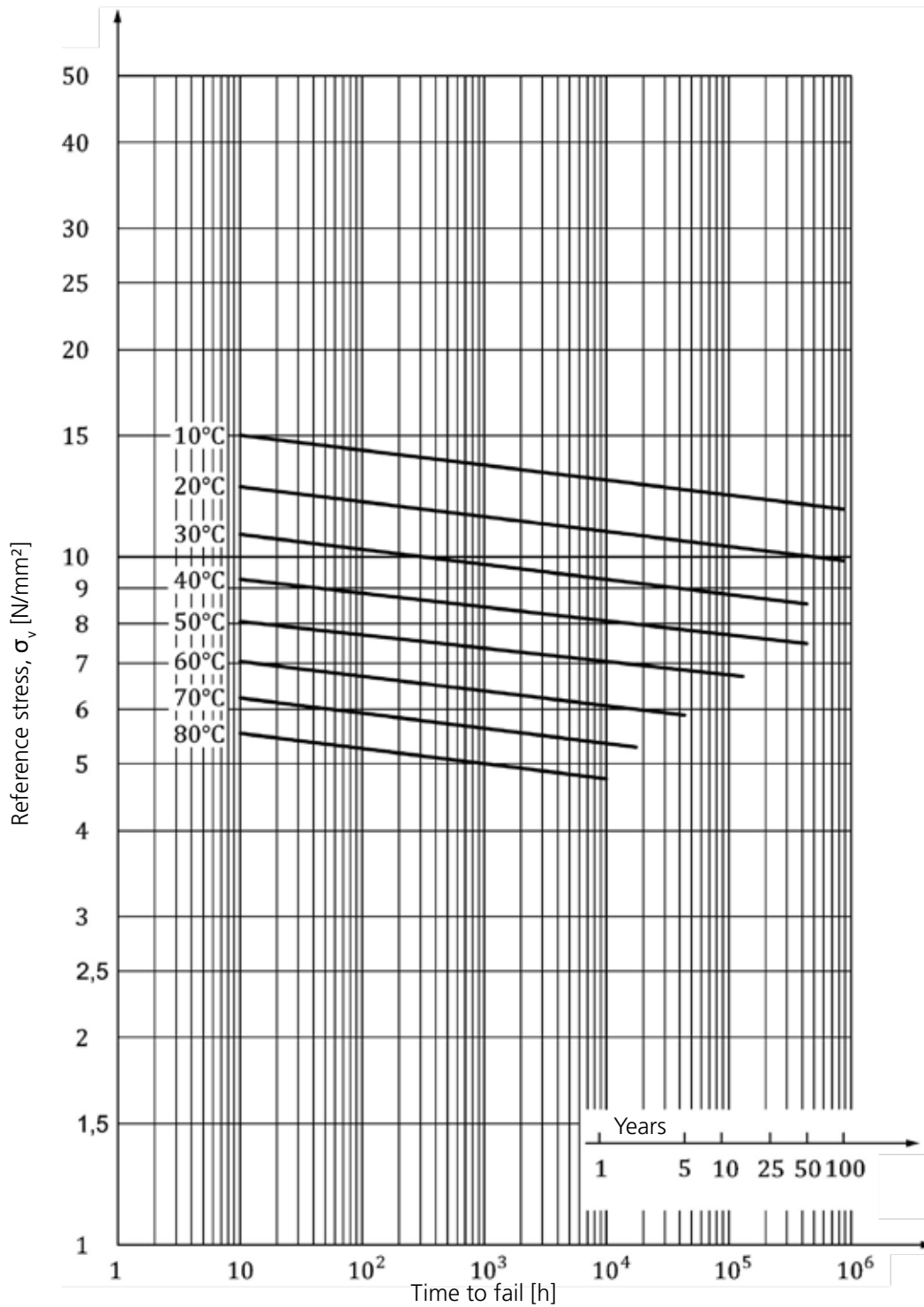

Figure A.2: Hydrostatic long-term strength (hoop stress graph) for PE 100 and PE 100-RC (Source: DIN 8075:2018-08, ISO 15494:2015-01)

### 2.1.3 Maximum operating pressure MOP

Temperature [°C]	Operating period [a]	Maximum operating pressure					
		[bar]					
		SDR 41	SDR 33	SDR 26	SDR 21	SDR 17	SDR 11
		ISO-S 20	ISO-S 16	ISO-S 12,5	ISO-S 10	ISO-S 8	ISO-S 5
10	5	5,0	6,3	7,9	10,0	12,6	19,9
	10	4,9	6,2	7,8	9,8	12,4	19,6
	25	4,8	6,1	7,7	9,6	12,1	19,2
	50	4,8	6,0	7,5	9,5	12,0	18,9
20	5	4,2	5,3	6,7	8,4	10,6	16,8
	10	4,2	5,2	6,6	8,3	10,4	16,5
	25	4,1	5,1	6,5	8,1	10,2	16,2
	50	4,0	5,0	6,3	8,0	10,0	16,0
30	5	3,6	4,5	5,7	7,2	9,0	14,3
	10	3,5	4,5	5,6	7,1	8,9	14,1
	25	3,5	4,4	5,5	6,9	8,7	13,8
	50	3,4	4,3	5,4	6,8	8,6	13,6
40	5	3,1	3,9	4,9	6,2	7,8	12,3
	10	3,0	3,8	4,8	6,1	7,6	12,1
	25	3,0	3,8	4,7	6,0	7,5	11,9
	50	2,9	3,7	4,7	5,9	7,4	11,7
45	5	2,9	3,6	4,6	5,7	7,2	11,5
	10	2,8	3,6	4,5	5,7	7,1	11,3
	25	2,8	3,5	4,4	5,5	7,0	11,1
50	5	2,7	3,4	4,3	5,4	6,7	10,7
	10	2,6	3,3	4,2	5,3	6,6	10,5
	15	2,6	3,3	4,2	5,2	6,6	10,4
55	5	2,5	3,2	4,0	5,0	6,3	10,0
	10	2,5	3,1	3,9	4,9	6,2	9,8
60	5	2,4	3,0	3,7	4,7	5,9	9,4

Table A.2: Maximum operating pressure of PE 100 and PE 100-RC (Source: DIN 8075: 2018, ISO 15494: 2015-01).

The data stated in the table above are applicable for water only. They were determined from the creep modulus curve taking into account a safety coefficient of  $C = 1.25$ .

For the calculation of the operating pressure in piping systems we recommend to multiply the values mentioned in the table with a system reduction coefficient  $f_s = 0.8$  (This value contains installation-technical influences such as welded joints, flanges or also bending loads).

## 2.1.4 Creep modulus curves

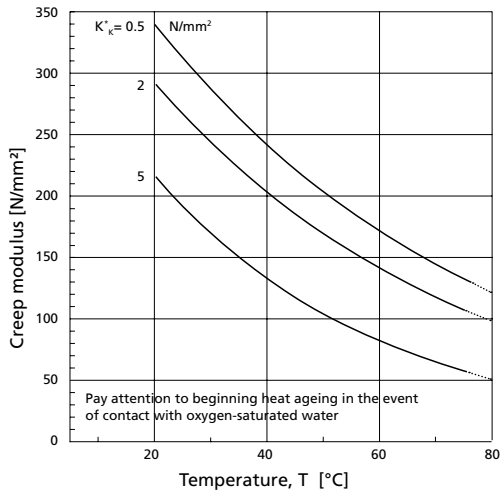

Figure A.3: Creep modulus of PE 100 and PE 100-RC for 1 year. (Source: DVS 2205-1)

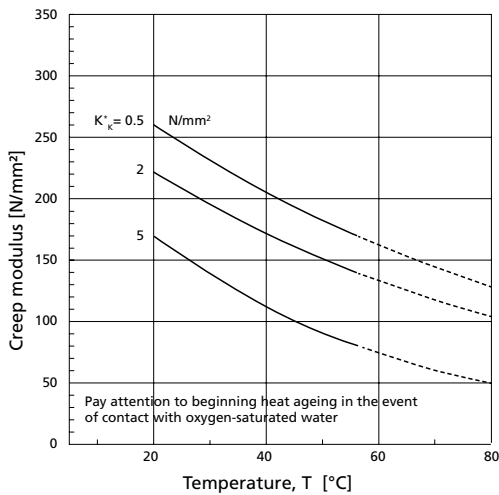

Figure A.4: Creep modulus of PE 100 and PE 100-RC for 10 years. (Source: DVS 2205-1)

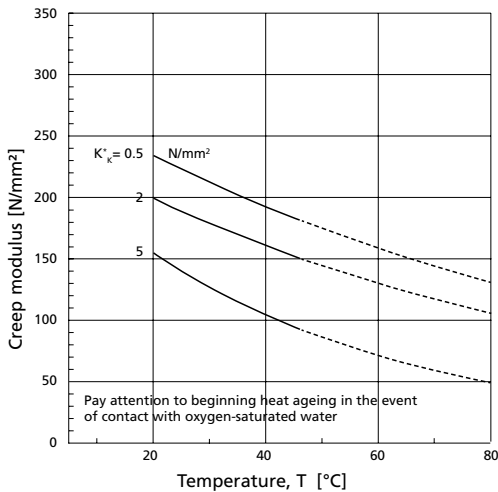

Figure A.5: Creep modulus of PE 100 and PE 100-RC for 25 years. (Source: DVS 2205-1)

The calculated creep modulus stated in the figures A3 to A5 has to be additionally reduced by a safety coefficient of  $\geq 2$  for stability calculations.

The influences of chemical attack or eccentricity and ovality have to be taken into account separately.

## 2.1.5 Isochronous stress/strain diagramm

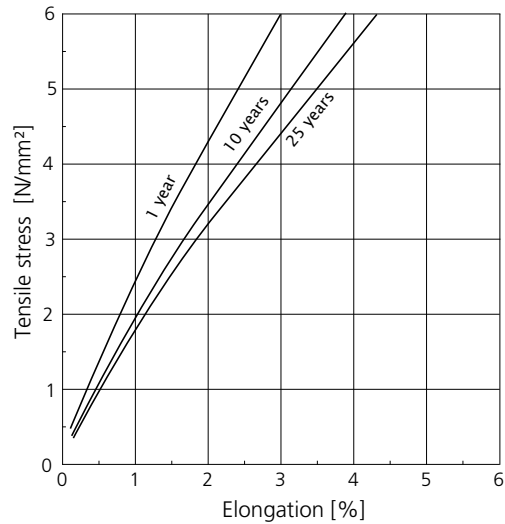

Figure A.6: Isochronous stress/strain diagramm of PE 100 for 23°.



## 2.1.6 Buckling pressure

Temperature [°C]	Operating period [a]	Permissible buckling pressure					
		SDR 41	SDR 33	SDR 26	SDR 21	SDR 17	SDR 11
20	1	0,054	0,107	0,212	0,429	0,854	3,376
	10	0,041	0,081	0,161	0,325	0,648	2,561
	25	0,037	0,074	0,146	0,296	0,589	2,328
30	1	0,047	0,092	0,183	0,370	0,736	2,910
	10	0,036	0,070	0,139	0,281	0,559	2,212
	25	0,034	0,066	0,132	0,266	0,530	2,095
40	1	0,037	0,074	0,146	0,296	0,589	2,328
	10	0,032	0,062	0,124	0,251	0,500	1,979
	25	0,030	0,059	0,117	0,237	0,471	1,863
50	1	0,032	0,062	0,124	0,251	0,500	1,979
	10	0,028	0,055	0,110	0,222	0,442	1,746

Table A.3: Permissible buckling pressure of PE 100.

The data stated in the table applies to water. A safety coefficient of 2.0 (minimum safety coefficient for stability calculations) has been taken into account.

These buckling pressures have to be decreased by the corresponding reduction factors for chemical influences or ovality.

## 3 Nominal stiffness

The ring stiffness SN describes the carrying capacity of the pipe crown. SN (unit: kN/m<sup>2</sup>) means stiffness number and is divided into classes, which are determined experimentally. 21 days after the pipe production, the pipe is deformed to ca. 3% and the surface load, needed for the deformation is measured. A pipe with a nominal stiffness SN 2 can withstand a surface load of 2 kN/m<sup>2</sup> at a deformation of < 3%.

The influence of the stiffness on flexible plastic piping systems is overestimated. The pipe must offer a sufficient stiffness during the installation to bear the loads resulting from the compaction. With a good compaction work within the embedment the soil carries the occurring loads. Due to the deformation of the pipe (usually 2 - 3 %) the load isn't transferred to the pipe. After a period of approximately 2 years (relaxation) the pipe lies load-free in the soil. A nominal stiffness of 8 kN/m<sup>2</sup> is regarded as optimal and sufficient.

The ring stiffness is classified into the following grades after EN 12201-2:

SDR	ISO S	SN [kN/m <sup>2</sup> ]
41	20	1,3
33	16	2,5
26	12,5	5,3
21	10	10,4
17	8	20,3
13,6	6,3	41,7
11	5	83,3
9	4	162,8
7,4	3,2	317,9
6	2,5	668,7

Table A.4: Initial stiffness of pipes (calculated with Young's Modulus E = 1000 MPa)

## 4 Resistance of polyethylene

### 4.1 Physical resistance

#### 4.1.1 Physiological safety

Polyethylene complies with the relevant food law requirements (according to ÖNORM B 5014 Part 1, BGA, KTW guidelines).

PE pipes and fittings are verified regarding drinking water suitability and registered according to DVGW guideline W270.

#### 4.1.2 Behaviour at radiation exposure

Pipes made of polyethylene may be used in the field of high energy radiation. PE pipes are well established as drainages for radioactive sewage from laboratories as well as cooling water systems for nuclear power plants.

Common radioactive sewage contains sources of beta and gamma rays. PE piping systems do not become radioactive, even after many years in use.

Also PE pipes are not damaged in the vicinity of higher radioactivity, provided that they aren't exposed to a regularly spread radiation dose larger than  $<10^4$  Gray during their entire operation time.

#### 4.1.3 Behaviour with abrasive fluids

In general, thermoplastic pipes are better suited for the conveying of fluid-solid-mixtures than concrete or steel pipes. This is confirmed by several test results as well as positive application experiences.

For the testing of the abrasive behavior the Darmstadt tipping trough test can be used. During the experiment, a 1 meter long pipe (half-pipe cut lengthwise) is used, which is filled with a sand-gravel-water mix (46 vol-% silica sand/gravel, grain size up to 30 mm). After being filled, the pipe is tipped with a frequency of 0.18 Hz.

The local decrease of the wall thickness after a certain time is used as a measure for the abrasion.

The advantage of thermoplastic pipes for the transport of solids in open channels can be clearly seen from the test results.

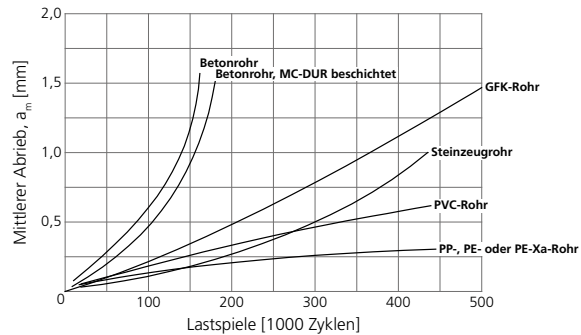

Figure A.7: Abrasion behaviour according to Darmstadt method (DIN EN 295-3).

Source: Technical University of Darmstadt

## 4.2 Chemical resistance

Compared to metals, where an attack of chemicals leads to an irreversible chemical change of the material, for plastics, the physical changes of the application reduce the utility value. Such physical changes are e.g. swelling and solution processes where the structure of the plastics can be changed in a way that effects the mechanical properties. Reduction factors have to be considered when designing facilities or parts of them.

PE is resistant to diluted solutions of salts, acids and alkalis if these are not strongly oxidizing agents. A good resistance to many solvents such as alcohols, esters and ketones is given as well.

During the contact with solvents (aliphatic or aromatic compounds, chlorinated hydroxycarbon) a strong swelling can be expected, especially at higher temperatures. Nevertheless the destruction of the materials is unusual.

The chemical resistance of the material can be strongly reduced by stress cracking corrosion due to surface-active fluids (chromic acid, concentrated sulphuric acid).

## 4.2.1 Bases

### 4.2.1.1 Alkaline lye

Aqueous alkali solutions (e.g. caustic potash, caustic soda solutions), don't react with PE even at higher temperatures and with higher concentrations. Therefore it can be used in PE-systems without any problems.

### 4.2.1.2 Sodium hypochlorite

Since this base contains active chlorine, only a limited resistance can be expected at room temperature.

At higher temperatures and a concentration of higher than 3 mg/l PE is only suitable for non-pressurised piping systems.

### 4.2.1.3 Hydrocarbons

PE is resistant against hydrocarbons (petroleum and other fuels) up to temperature of 40 °C (conveyance of the fluids) and up to 60 °C (storage of the fluids).

At temperatures higher than 60 °C PE has a limited resistance, because the swelling exceeds 3 %.

## 4.2.2 Acids

### 4.2.2.1 Sulphuric acid

Concentrations up to approximately 78 % only slightly change the properties of PE. Concentrations higher than 85 % cause oxidation at room temperature.

### 4.2.2.2 Hydrochloric and hydrofluoric acids

PE is chemically resistant to concentrated hydrochloric and hydrofluoric acids.

At concentrations higher than 20 % (HCl) or 40 % (HF) a diffusion of the acid is possible.

Even though PE isn't damaged itself, secondary damages are caused to the surrounding steel constructions. For that purpose, double containment piping systems have proven their reliability.

### 4.2.3 Nitric acid

Nitric acid with higher concentrations causes an oxidizing effect on materials. Therefore mechanical properties are reduced at higher concentrations.

### 4.2.4 Phosphoric acid

PE is resistant against this medium at higher concentrations and at higher temperatures.

If you have further questions regarding the resistance of our products, please feel free to contact our technical engineering department ([anwt@agru.at](mailto:anwt@agru.at)).

<b>1</b>	<b>SDR - Standard Dimension Ratio</b>	85
<b>2</b>	<b>S-Series</b>	85
<b>3</b>	<b>Maximum operating pressure</b>	85
<b>4</b>	<b>Wall thickness</b>	85
<b>5</b>	<b>Buckling pressure (low pressure)</b>	86
<b>6</b>	<b>Pipe cross-section</b>	86
<b>7</b>	<b>Hydraulic pressure losses</b>	87
<b>8</b>	<b>Elongation</b>	90
<b>9</b>	<b>Restraint load</b>	90
<b>10</b>	<b>Expansion bends</b>	92
<b>11</b>	<b>Pipe spans</b>	93
<b>12</b>	<b>Calculation aids</b>	94



Standards and approvals

Installation guide

Connection technology

Calculation guide

Material properties

## 1 SDR - Standard Dimension Ratio

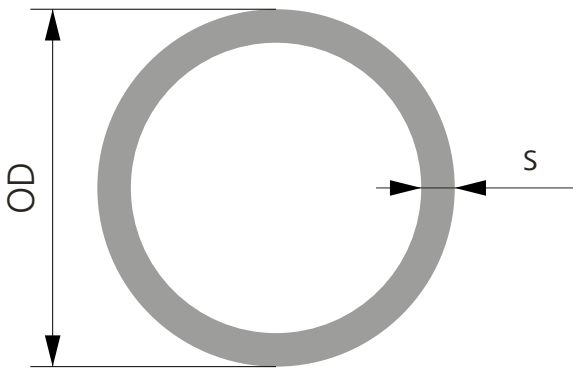

Figure B.1: Dimensions of a pipe.

$$SDR = \frac{OD}{s}$$

Formula B.1: SDR.

- OD outer diameter [mm]  
 s wall thickness [mm]  
 SDR outer diameter to wall thickness-ratio [1]

## 2 S-Series

$$S = \frac{SDR - 1}{2}$$

Formula B.2: S-Series.

- S ISO S-Series [1]  
 SDR standard dimension ratio [1]

## 3 Maximum operating pressure

$$MOP = \frac{20 \cdot \sigma}{c \cdot (SDR - 1)}$$

Formula B.3: Maximum operating pressure.

- c minimum safety factor [1]  
 MOP maximum operating pressure [bar]  
 SDR standard dimension ratio [1]  
 $\sigma$  hoop stress [N/mm<sup>2</sup>]

	Minimum safety factor [1]	
	Potable water / sewage	Natural gas
PE 100, PE 100-RC	1.25	2.0

Table B.1: Minimum safety factor.

For the hoop stresses see chapter A "Hydrostatic long-term strength".

## 4 Wall thickness

Strength calculations of thermoplastic plastic pipelines are generally based on long-term values. These strength values, which depend on the temperature, are derived from the hydrostatic long-term strength curve (see chapter A).

After the calculation of the arithmetical wall thickness the operating wall thickness is specified by using the nominal pressure or the SDR-class.

Safety margins for the wall thickness have to be taken into account (e.g. for the outdoor operation of the PE pipeline without UV protection or for the transport of abrasive substances).

$$s_{\min} = \frac{p \cdot OD}{20 \cdot \sigma_s + p}$$

Formula B.4: Minimum wall thickness.

$$\sigma_s = \frac{\sigma}{c}$$

Formula B.5: Design stress.

- c minimum safety factor [1]  
 OD outer diameter [mm]  
 p operating pressure [bar]  
 $s_{\min}$  minimum wall thickness [mm]  
 $\sigma$  hoop stress [N/mm<sup>2</sup>]  
 $\sigma_s$  design stress [N/mm<sup>2</sup>]

For the hoop stress see chapter A "Hydrostatic long-term strength".

If required, the formula can be used to calculate the hoop stress  $\sigma$  or the operating pressure p.

## 5 Buckling pressure (low pressure)

In certain cases piping systems are exposed to external high pressure (low pressure inside the pipe):

- In-water installations or pipes buried below the groundwater level
- Systems for vacuum applications, e.g. suction pipes

$$p_k = \frac{10 \cdot E_c}{8 \cdot (1 - \mu^2)} \cdot \left( \frac{s}{r_m} \right)^3$$

Formula B.6: Buckling pressure (safety factor 2).

$$r_m = \frac{OD - s}{2}$$

Formula B.7: Mean radius.

The buckling stress can be calculated with following formula:

$$\sigma_K = 0,1 \cdot p_K \cdot \frac{r_m}{s}$$

Formula B.8: Buckling stress.

$E_C$	creep modulus for 25 years [N/mm <sup>2</sup> ]
OD	outer diameter [mm]
$p_K$	critical buckling pressure [bar]
$r_m$	mean pipe radius [mm]
$s$	wall thickness [mm]
$\mu$	Transversal contraction factor 0.38 [1]
$\sigma_K$	critical buckling stress [N/mm <sup>2</sup> ]

For the creep modulus see section A "Creep modulus curves".

Time period [years]	Temperature [°C]			
	20	30	40	50
1	290	250	200	170
10	220	190	170	150
25	200	180	160	-

Tabelle A.1: Guidelines for long term creep modulus for PE 100 and PE 100-RC from the creep modulus curves chapter 2.1.4 (stress: 2 N/mm<sup>2</sup>) (Source: DVS 2205-1)

## 6 Pipe cross-section

Flow processes are calculated by means of the continuity equation. For the fluids with constant volume flow, following equation is used.

$$\dot{V} = 0.0036 \cdot A \cdot v$$

Formula B.9: Volume flow.

For gases and vapours, the material flow remains constant. Therefore, the following equation can be used for the calculation.

$$\dot{m} = 0.0036 \cdot A \cdot v \cdot \rho$$

Formula B.10: Mass flow.

If the constants used in the above-mentioned equations are combined, you receive the formula for the required pipe cross section.

$$ID = 18.8 \cdot \sqrt{\frac{Q_1}{v}}$$

Formula B.11: Inner pipe diameter - m<sup>3</sup>/h.

$$ID = 35.7 \cdot \sqrt{\frac{Q_2}{v}}$$

Formula B.12: Inner pipe diameter - l/s.

A	free pipe cross-section [mm <sup>2</sup> ]
ID	inner pipe diameter [mm]
$\dot{m}$	mass flow [kg/h]
$Q_1$	flow rate [m <sup>3</sup> /h]
$Q_2$	flow rate [l/s]
$\dot{V}$	volume flow [m <sup>3</sup> /h]
$v$	flow velocity [m/s]
$\rho$	medium density depending on pressure and temperature [kg/m <sup>3</sup> ]

Reference values for the flow velocities:

- Fluids:
  - Suction side:  $v \approx 0.5$  up to 1.0 m/s
  - Pressure side:  $v \approx 1.0$  up to 3.0 m/s
- Gases:
  - $v \approx 10$  up to 30 m/s

## 7 Hydraulic pressure losses

Flowing media will experience pressure losses and therefore energy losses within the conveying system. The main factors for the losses are:

- Length of the piping system
- Pipe cross section
- Roughness of the pipe surface
- Geometry of fittings, mountings and finished joints or couplings
- Viscosity and density of the fluid

The whole pressure loss results from the sum of the following individual losses:

$$\Delta p_{ges} = \Delta p_R + \Delta p_{RF} + \Delta p_{RA} + \Delta p_{RV}$$

Formula B.13: Total pressure loss.

$\Delta p_{ges}$	total pressure loss [bar]
$\Delta p_R$	pressure loss in straight pipes [bar]
$\Delta p_{RA}$	pressure loss in mountings [bar]
$\Delta p_{RF}$	pressure loss in fittings [bar]
$\Delta p_{RV}$	pressure loss in finished joints or couplings [bar]

## 7.1 Pressure loss in straight pipes

The pressure loss in the straight pipes is inversely proportional to the pipe cross section.

$$\Delta p_R = \lambda \cdot \frac{L}{ID} \cdot \frac{\rho}{2 \cdot 10^2} \cdot v^2$$

Formula B.14: Pressure loss in straight pipes.

- ID inside diameter of pipe [mm]
- L length of piping system [m]
- $\Delta p_R$  pressure loss in straight pipes [bar]
- $\lambda$  pipe frictional index 0.02 (sufficient in most cases) [1]
- v flow velocity [m/s]
- $\rho$  medium density [kg/m<sup>3</sup>]

Pressure loss in pipes can also be calculated with the empirical Hazen-Williams equation (source: NFPA 13). Please note, that the equation is only valid for water.

$$p_m = 6.05 \cdot \left( \frac{Q_m^{1.85}}{C^{1.85} \cdot d_m^{4.87}} \right) 10^5$$

- $p_m$  frictional resistance [bar/m pipe]
- C design coefficient (PE-HD = 150)
- $Q_m$  flow rate [L/min]
- $d_m$  actual internal diameter [mm]

## 7.2 Pressure loss in fittings

Inside the fittings friction, deflection and detachment cause considerable pressure losses

The resistance coefficients, used for the calculation can be taken from the following chapter or from the technical literature.

$$\Delta p_{RF} = \zeta \cdot \frac{\rho}{2 \cdot 10^5} \cdot v^2$$

Formula B.15: Pressure loss in fittings.

- $\Delta p_{RF}$  pressure loss in fittings [bar]
- $\zeta$  resistance coefficient for fittings [1]
- v flow velocity [m/s]
- $\rho$  medium density [kg/m<sup>3</sup>]



## 7.2.1 Resistance coefficients for the fittings

Fitting	Parameter	Resistance coefficient [1]		Flow
Bend 90°	R	$\zeta$		
	1.0 × OD	0.51		
	1.5 × OD	0.41		
	2.0 × OD	0.34		
	4.0 × OD	0.23		
Bend 45°	R	$\zeta$		
	1.0 × OD	0.34		
	1.5 × OD	0.27		
	2.0 × OD	0.20		
	4.0 × OD	0.15		
Elbow	$\alpha$	$\zeta$		
	90°	~ 1.20		
	45°	0.30		
	30°	0.14		
	20°	0.05		
	15°	0.05		
	10°	0.04		
Tee 90°	$V_Z / V_S$	$\zeta_Z$	$\zeta_D$	
(confluence)	0.0	-1.20	0.06	
	0.2	-0.40	0.20	
	0.4	0.10	0.30	
	0.6	0.50	0.40	
	0.8	0.70	0.50	
	1.0	0.90	0.60	
Tee 90°	$V_A / V_S$	$\zeta_A$	$\zeta_S$	
(bifurcation)	0.0	0.97	0.10	
	0.2	0.90	-0.10	
	0.4	0.90	-0.05	
	0.6	0.97	0.10	
	0.8	1.10	0.20	
	1.0	1.30	0.35	

Table B.2: Resistance coefficient for fittings - part 1 (Source: DVS 2210-1).

Fitting	Parameter	Resistance coefficient [1]			Flow
		$4^\circ > \alpha < 8^\circ$	$\alpha < 16^\circ$	$\alpha < 24^\circ$	
Reduction	$OD_2 / OD_1$				
(pipe expansion)	1.2	0.10	0.15	0.20	
	1.4	0.20	0.30	0.50	
	1.6	0.50	0.80	1.50	
	1.8	1.20	1.80	3.00	
	2.0	1.90	3.10	5.30	
Reduction	$OD_1 / OD_2$				
(pipe constriction)	1.2	0.046	0.023	0.010	
	1.4	0.067	0.033	0.013	
	1.6	0.076	0.038	0.015	
	1.8	0.031	0.041	0.016	
	2.0	0.034	0.042	0.017	

Table B.3: Resistance coefficient for fittings - part 2 (Source: DVS 2210-1).

Positive  $\zeta$ -values represent a pressure drop, whereas negative  $\zeta$ -values represent a pressure increase.

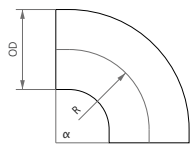
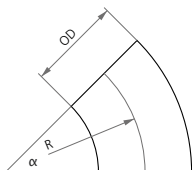
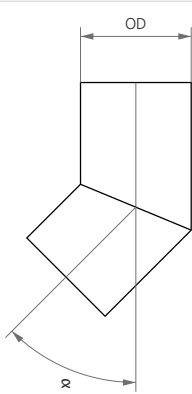
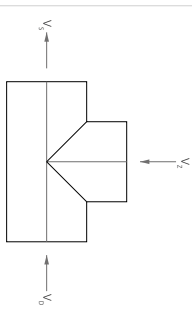
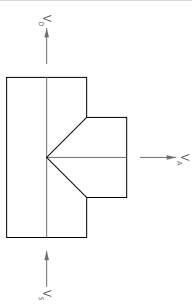
- $V_A$  outgoing volume flow
- $V_D$  continuous volume flow
- $V_S$  total volume flow
- $V_Z$  additional volume flow

### 7.3 Pressure loss in finished joints or couplings

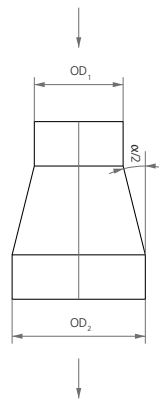
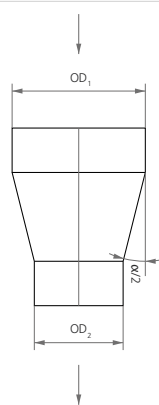
An exact calculation of the pressure loss is not possible, because the types and the qualities of the joints (welding joints, unions and flange joints) may vary.

It is recommended to use a resistance coefficient of  $\zeta_{RV} = 0.1$  for the consideration of the joints (butt and socket welding) and flanges in the pressure loss calculation.

$$\Delta p_{RV} = \zeta \cdot \frac{\rho}{2 \cdot 10^5} \cdot v^2$$

Formula B.16: Pressure loss in finished joints or couplings.

- $\zeta$  resistance coefficient for the mountings [1]  
 $v$  flow velocity [m/s]  
 $\rho$  density of the medium [kg/m<sup>3</sup>]

## 8 Elongation

Elongations of plastic piping systems are caused by the changes in the operating or test process. Following influence factors are possible:

- Elongation due to temperature change
- Elongation due to internal pressure
- Elongation due to chemical influence

### 8.1 Elongation caused by temperature change

If the piping system is exposed to different temperatures (operating or ambient temperatures) its position changes depending on the moving possibilities of each pipeline. A pipeline is assumed as the distance between two restraints.

The elongation is calculated as follows:

$$\Delta L_T = \alpha \cdot L \cdot \Delta T$$

Formula B.17: Elongation due to temperature change.

- $L$  pipe length [m]  
 $\alpha$  coefficient of linear expansion [mm/(m×K)]  
 $\Delta L_T$  elongation due to temperature change [mm]  
 $\Delta T$  temperature difference [K]

For the determination of  $\Delta T$  the lowest and the highest possible pipe wall temperature  $T_R$  during the installation, operation or standstill has to be considered.

	Linear expansion coefficient $\alpha$
PE 100 & PE 100-RC	0.18
PE-Xa	0.14

Table B.4: Linear expansion coefficient.

### 8.2 Elongation caused by internal pressure

The elongation due to internal pressure of a closed and friction-free installed piping system is:

$$\Delta L_p = \frac{0.1 \cdot p \cdot (1 - 2 \cdot \mu)}{E_c \cdot \left( \frac{OD^2}{ID^2} - 1 \right)} \cdot L$$

Formula B.18: Elongation due to internal pressure.

- $E_{C,100 \text{ min}}$  creep modulus [N/mm<sup>2</sup>]  
 $ID$  pipe inside diameter [mm]  
 $L$  length of piping system [mm]  
 $OD$  pipe outside diameter [mm]  
 $p$  operating pressure [bar]  
 $\Delta L_p$  elongation by internal pressure [mm]  
 $\mu$  Poisson ratio 0.38 [1]

## 9 Restraint load

Restraints (fixed points) should prevent a sliding or moving of the piping system in every direction. Furthermore restraints serve as compensations for the reaction forces when using compensators (sliding sockets and push-fit fittings). A restraint has to be dimensioned for all possible forces:

- Stress through restrained thermal expansion
- Weight of the vertical piping systems
- Specific weight of the fluid
- Operating pressure
- Inherent resistance of the compensators

Restraints which haven't been determined should be placed in a way that the direction changes in the pipeline are used for the absorption of the elongations.

Possible restraints are the edges of the fitting sockets or special restraint fittings.



Figure B.2: Restraint fitting.

Swinging clips or the clamping of the pipes are not suitable as restraints.

### 9.1 Rigid system

Restraining the elongation of a piping system leads to a fixed system.

Rigid or fixed piping length has no compensation elements. and has to be treated as a special case during the dimensioning.

Following parameters have to be calculated:

- Restraint load
- Permissible guiding element distance in consideration of the critical buckling length
- Occuring tensile and compressive stresses

The highest restraint loads occur on the straight, axially fixed pipe sections. In general it is calculated using the following formula.

$$F_{FP} = A_R \cdot E_C \cdot \epsilon$$

Formula B.19: Dog bone load.

$A_R$  annular surface of the pipe wall [mm<sup>2</sup>]  
 $E_C$  creep modulus for  $t = 100$  min [N/mm<sup>2</sup>]  
 $F_{FP}$  restraint loads in the fixed pipe section [N]  
 $\epsilon$  prevented longitudinal expansion (by heat expansion, internal pressure) [1]

Mean temperature $T_m$ [°C]	Creep modulus $E_C$ for 100 min [N/mm <sup>2</sup> ]
≤10	833
20	634
30	468
40	362
50	283
60	230

Table B.5: Creep moduli for 100 minutes (Source: DVS 2210-1 suppl. 1).

### 9.1.1 Load by thermal expansion

$$\epsilon = \alpha \cdot \Delta T$$

Formula B.20: Thermal expansion.

$\alpha$  coefficient of linear expansion [1/K]  
 $\Delta T$  max. temperature difference [K]  
 $\epsilon$  prevented longitudinal extension [1]

### 9.1.2 Load by internal pressure

$$\epsilon = \frac{0,1 \cdot p \cdot (1-2 \cdot \mu)}{E_C \cdot \left( \frac{d_a^2}{d_i^2} - 1 \right)}$$

Formula B.21: Extension due to the internal pressure.

$p$  operating pressure [bar]  
 $\mu$  Poisson's ratio 0.38 [1]  
 $E_C$  creep modulus for  $t = 100$  min [N/mm<sup>2</sup>]  
 $OD$  pipe outside diameter [mm]  
 $ID$  pipe inside diameter [mm]  
 $\epsilon$  prevented longitudinal extension by internal pressure [1]

### 9.1.3 Load by swelling

Caution: a fixed system where a material swelling is possible, should be generally avoided. Reason: the swelling causes a material weakening.



## 10 Expansion bends

Changes in length are caused by changes in operating or ambient temperature. If the piping systems are installed above ground, the axial movements have to be compensated sufficiently.

In most cases, changes of direction of the pipe sections can be used for the absorption of the elongations. Otherwise, expansion bends have to be installed.

The minimum length of the expansion bend is calculated as follows:

$$L_s = k \cdot \sqrt{\Delta L \cdot d_a}$$

Formula B.22: Minimum length of expansion bends.

$L_s$	min. length of the expansion bend [mm]
$k$	material specific proportionality factor [1]
$\Delta L$	system length of the expansion bend [mm]
OD	pipe outside diameter [mm]

If the result cannot be realised, compensators with minimal friction coefficient have to be used. Depending on the construction, they may be applied as axial, lateral or angular compensators.

	0 °C	10 °C	30 °C	40 °C	60 °C
PE k-value	multiple temperature changes				
	16	17	23	28	-
	single temperature change				
	12	12	16	17	-

Note: for the calculation of the k-values an installation temperature of 20 °C was taken into account. At lower temperatures the impact strength of the material has to be considered.

The k-values can be reduced by 30% for pressureless pipes (e.g. ventilation).

Between two restraints, a compensator has to be installed. An appropriate guiding of the piping at the loose points has to be ensured. For that matter the resulting reaction forces have to be taken into account.

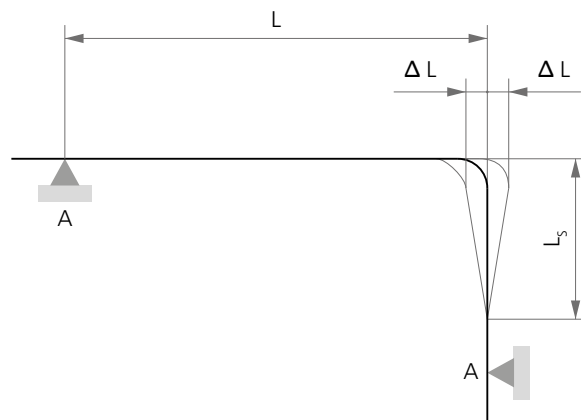

Figure B.3: L-compensation.

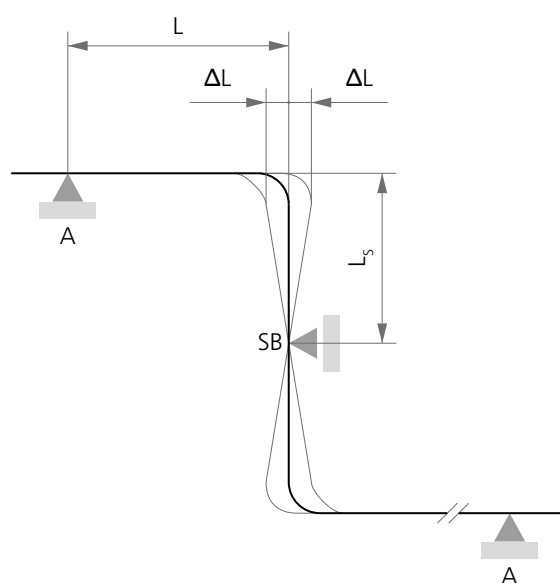

Figure B.4: Z-compensation.

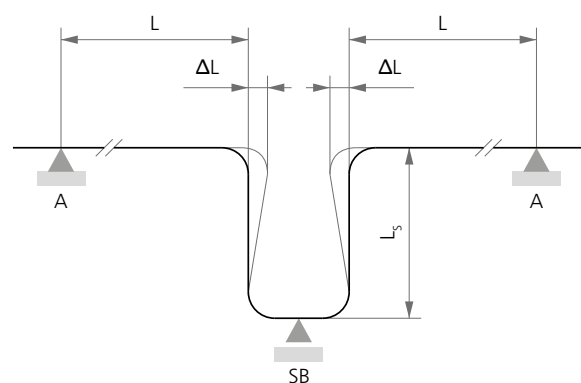

Figure B.5: U-compensation.

A restraints  
SB slide bearing

## 11 Pipe spans

When calculating the pipe spans of a thermoplastic piping system the permissible bending stress as well as a limited deflection of the pipeline have to be taken into account. For the maximum deflection a guidance value of  $L_A/500$  is normally assumed.

Using the above mentioned deflection value the permissible pipe span can be calculated with the following equation.

$$L_A = f_{LA} \cdot \sqrt[3]{\frac{E_C \cdot J_R}{q}}$$

Formula B.23: Pipe spans for installations above ground.

The factor  $f_{LA}$  is determined depending on the pipe outside diameter. The relation between both parameters is as follows:

$$\begin{aligned} \min &\leftarrow OD \rightarrow \max \\ 0.92 &\leftarrow f_{LA} \rightarrow 0.80 \end{aligned}$$

Usual support distances are stated in the following chapter.

In the rigid piping systems (see chapter Restraints) a critical buckling length has to be calculated. The critical buckling length is compared to the permissible pipe spans, whereupon the smaller value has to be considered.

$$L_{Kn, zul} = 3,17 \cdot \sqrt{\frac{W \cdot d_a}{2 \cdot \varepsilon \cdot A_R}}$$

$E_C$	creep modulus for 25 years [N/mm <sup>2</sup> ] (consider the reduction factor $\geq 2$ , see 2.1.4)
$f_{LA}$	deflection factor (0.80 - 0.92) [1]
$J_R$	moment of inertia of the pipe [mm <sup>4</sup> ]
$L_A$	permissible pipe span [mm]
$q$	line load (pipe, filling and additional weight) [N/mm]
$L_{Kn, zul}$	critical buckling length [mm]
$W$	section modulus of the pipe [mm <sup>3</sup> ]
$d_a$	outer diameter of the pipe (OD) [mm]
$\varepsilon$	prevented longitudinal extension [1]
$A_R$	pipe wall cross section [mm <sup>2</sup> ]

If the operating temperature is higher than 45 °C, the calculated pipe span  $L_{Kn}$  has to be reduced at least by 20 %.

## 12 Calculation aids

### 12.1 Conversion table

	<b>Pa = N/m<sup>2</sup></b>	<b>MPa</b>	<b>bar</b>	<b>mm WC</b>
1 Pa = N/m <sup>2</sup>	1	10 <sup>-6</sup>	10 <sup>-5</sup>	10 <sup>-2</sup>
1 MPa = 1 N/mm <sup>2</sup>	10 <sup>6</sup>	1	10	1.02 · 10 <sup>5</sup>
1 bar	10 <sup>5</sup>	0,1	1	1.02 · 10 <sup>4</sup>
1 mm WC	9.81	9.81 · 10 <sup>-6</sup>	9.81 · 10 <sup>-5</sup>	1

Table B.6: Conversion pressure units

	<b>mm</b>	<b>cm</b>	<b>dm</b>	<b>m</b>	<b>km</b>
1 mm	1	10 <sup>-1</sup>	10 <sup>-2</sup>	10 <sup>-3</sup>	10 <sup>-6</sup>
1 cm	10	1	10 <sup>-1</sup>	10 <sup>-2</sup>	10 <sup>-5</sup>
1 dm	10 <sup>2</sup>	10	1	10 <sup>-1</sup>	10 <sup>-4</sup>
1 m	10 <sup>3</sup>	10 <sup>2</sup>	10	1	10 <sup>-3</sup>
1 km	10 <sup>6</sup>	10 <sup>5</sup>	10 <sup>4</sup>	10 <sup>3</sup>	1

Table B.7: Conversion length units

	<b>mm<sup>2</sup></b>	<b>cm<sup>2</sup></b>	<b>dm<sup>2</sup></b>	<b>m<sup>2</sup></b>
1 mm <sup>2</sup>	1	10 <sup>-2</sup>	10 <sup>-4</sup>	10 <sup>-6</sup>
1 cm <sup>2</sup>	10 <sup>2</sup>	1	10 <sup>-2</sup>	10 <sup>-4</sup>
1 dm <sup>2</sup>	10 <sup>4</sup>	10 <sup>2</sup>	1	10 <sup>-2</sup>
1 m <sup>2</sup>	10 <sup>6</sup>	10 <sup>4</sup>	10 <sup>2</sup>	1

Table B.8: Conversion area units

	<b>t</b>	<b>kg</b>	<b>g</b>	<b>mg</b>
1 t	1	10 <sup>3</sup>	10 <sup>6</sup>	10 <sup>9</sup>
1 kg	10 <sup>-3</sup>	1	10 <sup>3</sup>	10 <sup>6</sup>
1 g	10 <sup>-6</sup>	10 <sup>-3</sup>	1	10 <sup>3</sup>
1 mg	10 <sup>-9</sup>	10 <sup>-6</sup>	10 <sup>-3</sup>	1

Table B.9: Conversion mass units

	<b>mm<sup>3</sup></b>	<b>cm<sup>3</sup></b>	<b>dm<sup>3</sup></b>	<b>m<sup>3</sup></b>
1 mm <sup>3</sup>	1	10 <sup>-3</sup>	10 <sup>-6</sup>	10 <sup>-9</sup>
1 cm <sup>3</sup>	10 <sup>3</sup>	1	10 <sup>-3</sup>	10 <sup>-6</sup>
1 dm <sup>3</sup> = 1l water	10 <sup>6</sup>	10 <sup>3</sup>	1	10 <sup>-3</sup>
1 m <sup>3</sup>	10 <sup>9</sup>	10 <sup>6</sup>	10 <sup>3</sup>	1

Table B.10: Conversion volume units

OD [mm]	DN	inch
10	6	-
12	8	-
16	10	-
20	15	1/2
25	20	3/4
32	25	1
40	32	1 <sup>1/4</sup>
50	40	1 <sup>1/2</sup>
63	50	2
75	65	2 <sup>1/2</sup>
90	80	3
110	100	4
125	100	4 <sup>1/2</sup>
140	125	5
160	150	6
180	150	7
200	200	8
225	200	9
250	250	10
280	250	11
315	300	12
355	350	14
400	400	16
450	500	18
500	500	20
560	600	22
630	600	25
710	700	28
800	800	32
900	900	36
1000	1000	40
1200	1200	48
1400	1400	54
1600	1600	66
1800	1800	72
2000	2000	78
2250	2250	90
2500	2500	102
2720	2720	108
2830	2830	114
3000	3000	120
3260	3260	132

Table B.11: Relation between the outer diameter (OD), the nominal diameter, and the inch dimensions.

1	3.28	39.37
metre	feet	inch
[m]	[ft]	[in]
1	0.264	0.035
litre	gallons	cubic feet
[l]	[Ga]	[ft <sup>3</sup> ]
1	2.204	9.81
kilogram	pounds	Newton
[kg]	[lbs]	[N]
1	14.505	100
bar	pound/sq. inch	kilopascal
[bar]	[psi]	[kPa]

Table B.12: Conversion SI-units

## 12.2 Formula

### 12.2.1 Circle

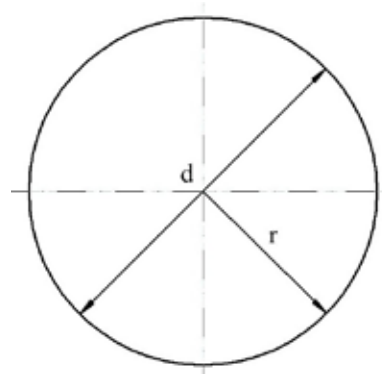

Area

$$A = \frac{\pi}{4} \cdot d^2 = \pi \cdot r^2$$

Circumference

$$U = 2 \cdot \pi \cdot r = \pi \cdot d$$

### 12.2.2 Cylinder

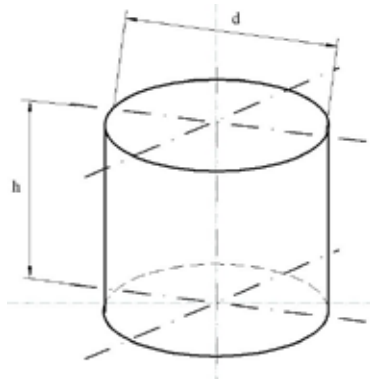

Lateral area

$$A_m = 2 \cdot \pi \cdot r \cdot h$$

Surface

$$A_o = 2 \cdot \pi \cdot r \cdot (r + h)$$

Volume

$$V = \frac{\pi}{4} \cdot d^2 \cdot h$$

### 12.2.3 Circular ring

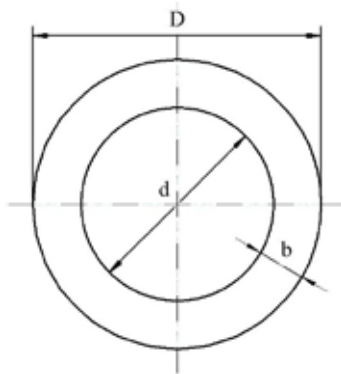

Area

$$A = \frac{\pi}{4} \cdot (D^2 - d^2)$$

### 12.2.4 Hollow cylinder (pipe)

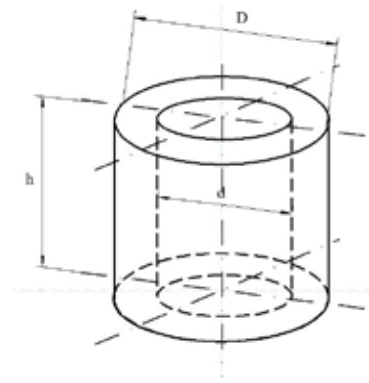

Volume

$$V = \frac{\pi}{4} \cdot h \cdot (D^2 - d^2)$$

A area [mm<sup>2</sup>]

A<sub>m</sub> lateral area [mm<sup>2</sup>]

A<sub>o</sub> surface [mm<sup>2</sup>]

V volume [mm<sup>3</sup>]

U circumference [mm]

r radius [mm]

D diameter (outside) [mm]

d diameter (inside) [mm]

h height [mm]

b wall thickness [mm]



<b>1</b>	<b>General requirements</b>	99
<b>2</b>	<b>Heated tool butt welding at site</b> (according DVS 2207-1 standard)	100

Marine Installation

Installation guide

**Heated tool butt welding**

Calculation guide

Material properties

## 1 General requirements

(applies to all welding processes)

The quality of welded joints depends on the qualification of the welder, the suitability of the utilized equipment and devices as well as on compliance with the welding standards. The welded joint can be tested by means of non-destructive and/or destructive methods.

The welding work must be monitored. Type and range of supervision has to be agreed between the contract partners. It is recommended to record the welding data in welding protocols or on data carriers.

Every welder has to be trained and has to be in possession of a valid qualification certificate. The intended application range may be decisive for the kind of qualification. For the industrial piping system construction, the technical code DVS 2212-1 is valid.

The equipment and devices which are used for welding must comply with the requirements in DVS 2208-1. The welding of plastics for indoor applications is described in the technical codes DVS 1905-1 and -2.

### 1.1 Requirements for welding

The welding zone must be protected against bad weather influences (e.g. wind, moisture).



Figure C.1: Preparation of the welding zone acc. to DVS

If it is ensured by suitable measures (e.g. preheating, tent, heating) that the conditions are suitable for welding, work may be carried out at any outside temperature insofar as the welder is not hindered in his handling. (fig. D.1)

### An additional proof must be provided by carrying out sample welds under the mentioned conditions

If the semi-finished product (pipe or fitting) is heated up unevenly under influence of sunshine, a temperature compensation in the area of the welding joint can be reached by covering. A cooling down during the welding process by ventilation has to be avoided. During welding the pipe ends have to be closed additionally to avoid stack effect.

PE-HD-pipes from coils are oval and bent immediately after uncoiling. The pipe end must be prepared before welding, e.g. by careful heating up with a hot-air equipment and/or use of a suitable clamping res. re-rounding device.

The joining zones of the components to be welded must be undamaged and have to be free of contaminations (e.g. dirt, grease, shavings).

Before welding the joining areas have to be cleaned with a special cleaning agent (PE cleaning agent consisting of isopropanol, acetone or ethanol acc. to DVGW VP 603)

**Caution:** Pipes and fittings contaminated with silicone grease cannot be cleaned with most of the cleaning agents. In that case brake cleaner fluid can be used. However the suitability has to be checked with the manufacturer and additional welds have to be carried out.

During all welding procedures the welding area has to be free of flexural stresses (e.g. by careful storage, roller blocks). Also a correct axial alignment has to be ensured.

Agru welding guidelines are valid for the welding of pipes and fittings made of thermoplasts stated in the table D.1.

Table C.1: material	Table C.2: weldability
PE-80, PE-100, PE-100 RC	MFR(190/5)= 0.3 - 1.7 (g/10min)  0.2 - 1.3 (g/10min) for welding of branches

Table C.3: Thermoplasts for the welding (Source: DVS 2207-1)

## 1.2 Requirements welding machines

All welds have to be carried out using welding machines and devices, which fulfill the requirements of DVS 2208-1.

The welding device or machine must be inspected at certain intervals by an expert and the heating elements must be cleaned with appropriate cleaning agents.

## 2 Heated tool butt welding at site (according DVS 2207-1 standard)

The recommended connection method is the heating tool butt welding following the DVS welding guidelines as described below. The required welding parameter according DVS 2207-1 standard for the offered pipes can be found in the operating instructions of the welding machine.

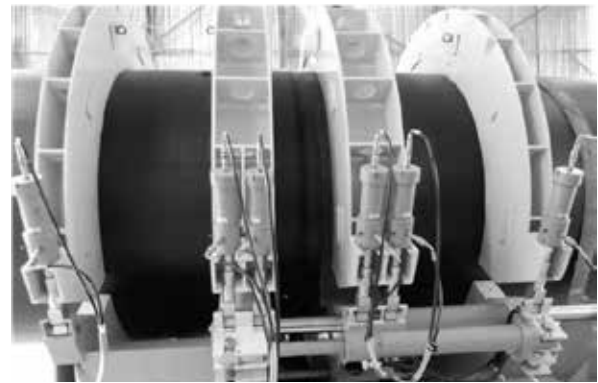

For heated tool butt welding the joining areas are heated-up to the welding temperature by means of the heated element and joined under pressure after removing. The temperature of the heating element is  $220^{\circ}\text{C} \pm 10^{\circ}\text{C}$ . The different steps of the welding process are illustrated in figure 2.

Only suitable butt fusion equipment and trained personnel must be used for executing the welds in the field and workshop. Also necessary precautions must be taken to ensure dry and clean environment in the welding area (e.g. tent to protect from rain and wind) all the time when welding is executed.

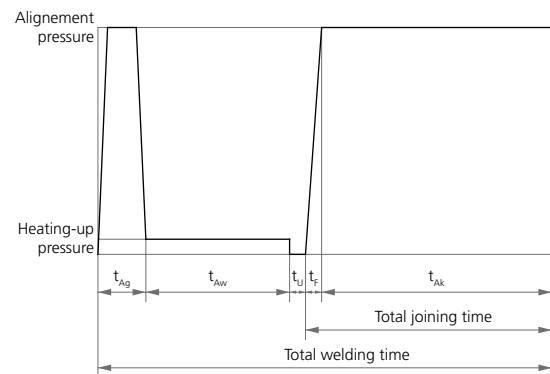

Figure C.2: Process steps of heated tool butt welding acc. to DVS 2207-1.

## 2.1 Adjustment

Before the parts can be welded they have to be adjusted in the clamps whereby the following criteria's have to be taken into account:

The ends of the parts to be welded have to come out of the clamps on such a length that a proper planning and joining can be ensured. Neither the planer or later the welding bead must come in contact with the clamping inserts. If possible both ends should come out almost equal that the parallel alignment of both parts can be realised easier by increasing or decreasing the force on the clamps. Both ends have to be aligned on a way that an eventual ovality divided equal all around the whole circumference.

In this phase of the drag force (tensile force) has to be evaluated. The drag force is caused by the weight of the part clamped on the moveable side of the welding machine, as well as by the friction of the moving table (clamps) of the welding machine. This force has to be added to the alignment and the joining force for every joint.



The pipes must be proper supported (e.g. with pipe roller supports), to ensure a straight and stress-free alignment on the welding machine.

## 2.2 Alignment

The joining areas of the welding components are pressed to the heated tool until all areas are coplanar on the heated tool. This fact is visible on the formation of beads. The drag force (pulling force) has to be added to the alignment force.

The alignment is finished when the bead heights have reached the mentioned values on the total pipe circumference or the total sheet surface respectively. The bead sizes are an index for a complete contact of the joining areas on the heated tool.

## 2.3 Heating Up

For heating-up, the joining areas must contact the heated tool with low pressure. The pressure is reduced to nearly zero ( $\leq 0,01 \text{ N/mm}^2$ ). During heating-up, the heat penetrates the joining areas and the required welding temperature is reached.



## 2.4 Changeover

After heating-up, the joining areas are to be detached from the heated tool. The heated tool should be withdrawn without damage or contamination of the heated joining zones. The joining areas should be brought together quickly until directly before the contact. The changeover time should be as short as possible, as otherwise the plasticised areas will cool down. The welding joint quality would be influenced negatively if the changeover time is too long.

## 2.5 Joining

The areas to be welded should meet with a speed of nearly zero. The demanded joining pressure is built possibly linear. The drag force (pulling force) has to be added to the joining force/ pressure. Raised mechanical loads during or directly after the de clamping are allowed only after cooling is finished. The joining pressure has to be kept completely during the cooling time at ambient temperature. The reduction of the cooling time up to 50 %, that means joining pressure release and removal of the welded part from the welding equipment, is allowed under the following requirements:

- The welding is done under workshop conditions.
- The removal from the welding equipment and the temporary storage are causing only slight loads to the joint.
- It concerns components with a wall thickness of  $\geq 15 \text{ mm}$ .





A further treatment with full mechanic load of the joint is allowed only after complete cooling down.

After the joining, a uniform double-bead should appear. The bead size shows the regularity of the welds. Different beads could be caused by different melt flow behaviour of the joined materials.

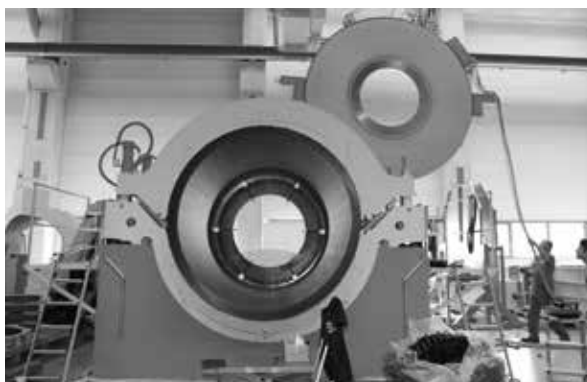

Figure C.3: Bead design at heated tool butt welding (principle) of a pipe.



## 2.6 Required tools

Heated tool butt welding machine - according to DVS 2208-1.



- Temperature gauge - to check the temperature (regularity) on the heating plate.



- Welding tent with crane:

Welding tent is required / recommended to protect the welding utility from bad weather influences (e.g. rain, wind, moisture).

A crane is required to manipulate the pipe, the planer and the heating element into the, and from the machine. It is recommended to use a fast-running crane to be able to remove the heating element in a short time and to keep the changeover time as short as possible.



The width of the welding tent depends on the quantity of pipe strings to be welded next to each other. After finishing one pipe string, the heated tool butt welding machine - according to DVS 2208-1, has to be positioned sideways to the area of the second pipe string.

<b>1</b>	<b>Transport / Handling / Storage</b>	105
<b>2</b>	<b>Installation</b>	106
<b>3</b>	<b>Relining</b>	111

Marine Installation

**Installation guide**

Heated tool butt welding

Calculation guide

Material properties

## 1 Transport / Handling / Storage

### 1.1 Pipes

During the transport of AGRU PE100 / PE 100-RC pipes, the cargo area of the vehicle should be clean and free from sharp objects such as nails, screws etc.

It is recommended to support the pipes along their entire length. The height of the pipe crates should not exceed 1 m (pipes > 1000 mm diameter have to be stored in bulk). When loading into containers, pay attention that the pipes are protected against damage and slipping. This can be done by suitable tension belts or wooden crates. The pipe ends must be sealed with films against dirt.



Pipe ends should not overhang for extended periods. When several pipe dimensions are transported on one vehicle, the smaller and lighter pipes should be placed on top.

Impacts on pipes should be avoided as much as possible. Contact with oils, greases, colours, petroleum etc. should be avoided. At temperatures around the freezing point the pipes must be handled carefully.

Large diameter pipes should be protected from contamination during storage by capping the pipe ends.



During the unloading, care should be taken of not to drag the pipes over sharp edges. During the sto-

rage on site the pipes shouldn't be placed onto stones or sharp-edged objects.

For the PE-Xa pipes basically the same transport, handling and storage conditions are applied

According to the current ÖVGW and DVGW regulations, pipes and pipeline parts need to be checked for transport and storage damages before the positioning in the trench.

Pipes with grooves, scratches or areal abrasion of more than 10 % of the wall thickness cannot be installed.

Non-black PE pipes have a maximum UV-resistance of 2 years if exposed to direct sun irradiation (Central Europe).

### 1.2 Fittings

AGRU PE-fittings should be transported and stored only in the original packaging (protection against external influences).

When the fittings are palletised, the overhang should be avoided.



On site AGRU PE-fittings should be stored in a tent or a construction trailer. If the fittings are protected from moisture and stored in their original packaging an unlimited storage life can be expected.

In general it is recommended to remove the packaging only immediately before the welding process to prevent contamination or damaging.

## 2 Installation

### 2.1 Bending radius

The flexibility of the pipe ensures that minor deviations due to structural conditions can be absorbed by the pipe without the use of fittings. Reference values for the minimum bending radius of pipes are as follows:

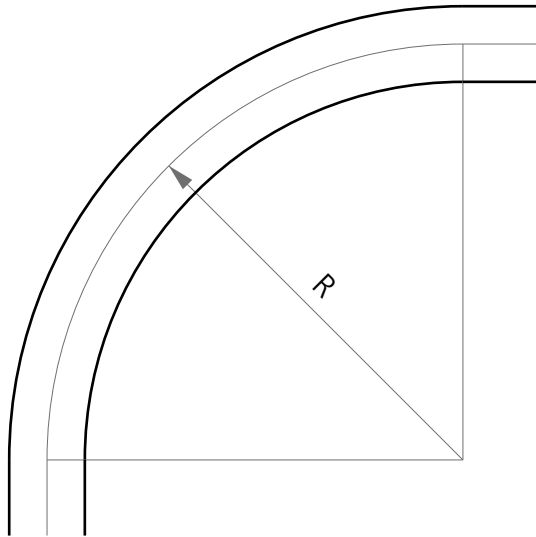

Figure D.1: Bending radius.

$$R = OD \cdot x$$

Formula D.1: Bending radius.

R Bending radius [mm]  
 OD Outer diameter of the pipe [mm]  
 x Multiplication factor

Installation temperature [°C]	Multiplication factor [x]		
	SDR 11+17	SDR 21-26	SDR 33-41
+30	20	30	50
+20	20	30	50
+10	35	52,5	87,5
0	50	75	125

Table D.1: Multiplication factor bending radius.

**Attention:** if fittings or flanges are installed in the bending area, a minimum bending radius of  $da \times 100$  must not be exceeded.

### 2.2 Open trench installation

For the construction of pipe trenches and the installation of the pipes, corresponding national and regional regulations have to be taken into account.

Generally changes in direction are realised by means of fittings (e.g.: bends, elbows and tees) whereas the fittings and pipes are welded together.

For big pipe dimensions the welding outside the trench has to be aimed in order to make work easier. For butt welding of big dimensions it is recommended to install the welding machine stationary and continue to pull the welded pipe sections after the welding.

For smaller pipes, which are laid along the trench or when using electro-socket welding, the welding machine can be transported to the welding spot. For cross-country installations a detection cable should be installed with the pipe in order to detect the pipeline easier in the future.

The following influencing factors on the installation technique and -depth have to be considered:

- Depth of frost or heat penetration (local conditions)
- Flow rate, pressure and temperature of the media in the pipeline
- Insulation of the pipeline
- Traffic and soil loads
- Soil type, soil moisture respectively ground water level and the surface conditions
- Crossing lines

**A structural analysis considering all influencing factors should be performed before each installation.**

**For this purpose acknowledged calculation guidelines (ATV-DVWK-A 127, AWWA M55, ÖNORM B 5012) have to be used.**



## 2.2.1 Open trench installation with sand bed

The most established installation technique is currently the open trench installation with sand bed. For the installation the trench should be at least 40 cm wider than the pipe diameter. The trench depth should be excavated considering national standards. In doing so the crown of the pipe should be located underneath the depth of frost (especially important for water application). The trench bottom should be planar, stable and free of stones. A bedding layer of at least 10 cm (rocky ground: 15 cm) should be placed on the trench bottom. The pipeline should be lowered into the trench carefully. Additionally an all-side cover have to be created (at least 10 cm) to avoid scratches and point-loads.

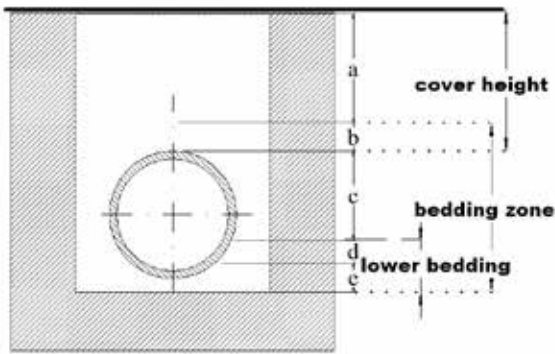

Figure D.2: Diagram of a trench

a. Backfill	excavated material may be reused
b. Cover	min. 10 cm around the pipe
c. Side bedding layer	
d. Upper bedding layer	
e. Lower bedding layer	

Table D.2: Guidelines bedding/backfill

### 2.2.1.1 Trench width

The trench width must be sufficiently wide to ensure a safe work and a professional installation of the pipeline. Trenches wider than 0.80 m have to be provided with covers (e.g. footbridge or walkway surface).

Guidelines for minimum trench width [mm] depending on the outside diameter (OD)			
OD[mm]	obstructed trench	unobstructed trench	
		$\beta^{1)} > 60^\circ$	$\beta^{1)} \leq 60^\circ$
$\leq 225$	OD + 400	OD + 400	
$> 225 \text{ bis } \leq 355$	OD + 500	OD + 500	OD + 400
$> 355 \text{ bis } \leq 710$	OD + 700	OD + 700	
$> 710 \text{ bis } \leq 1200$	$d_a + 850$	$d_a + 850$	
$> 1200$	$d_a + 1000$	$d_a + 1000$	
depending on the trench depth			
depth [mm]		width [mm]	
$< 1000$		not specified	
$\geq 1000 \text{ to } \leq 1750$		800	
$> 1750 \text{ to } \leq 4000$		900	
$> 4000$		1000	

Table D.3: Guidelines for trench width (source: DIN EN 1610).  
<sup>1)</sup> slope angle

### 2.2.1.2 Bedding material

The bedding material should be suitable for the particular pipeline, i.e. it must not cause corrosion, chemical or mechanical damage. A material is suitable for the bedding if it has sufficient compressibility (e.g. sand-gravel mixture, a proctor density of 90-95% is recommended). The bedding ensures that the surrounding soil absorbs the forces caused by internal pressure and external loads.

	DN	grain size [mm]	
		round	crushed
PE 100 pipe	≤ 200	0-22	0-11
	> 200	0-40	0-11
PE 100-RC pipe	≤ 63	0-22	
	> 63	0-100	

Table D.4: Guidelines for the mean grain size in the embedment (acc. to DVGW W 400-2 and ÖVGW/GRIS QS-W 405/1)

The cover should be at least 1 m higher than the crown of the pipe. The trench has to be back-filled directly after the installation to prevent damage on the pipeline. Unless specified otherwise (e.g. road-works) the excavated material can be reused as backfill.

Type of pipe	Depth of cover [m]
Water line	0.9 <sup>1)</sup> - 1.8 m
Gas line	0.6 <sup>1)</sup> - 1.3 m
Sewerage line	min. 2.0 m

Table D.5: Guidelines for the depth of cover (acc. to DVGW W 400-1)

<sup>1)</sup> In the agricultural areas a minimum depth of cover of 1.2 m is recommended.

### 2.2.2 Installation without sand bed

Soil characteristics as well as the pipe material are essential for the selection of the appropriate installation method.

In addition to the installation with a sand bed PE 100-RC pipes and fittings can be used for alternative installation techniques such as installation without sand bed or trenchless installation.

Installation without sand bed means that the excavated soil can be reused to refill the trench as long as the soil is compressible acc. to the current standards (e.g. ÖNORM B2538 and ÖNORM B5016). The requirements for the grain sizes in a sandbed-free installation are stated in the ÖNORM B 2538.

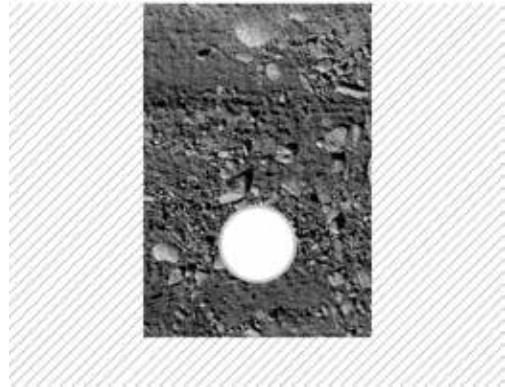

Figure D.3: Diagram of a trench after a sandbed-free installation.

DN/OD <63	up to 22 mm
DN/OD ≥63	up to 100 mm

Table D.6: Guidelines for the grain size of the bedding material (acc. to ÖVGW QS-W 405-1)

## 2.2.3 Calculation of buried piping systems

A stress and deformation proof according to ATV-DVWK-A 127, AWWA M55, has to be furnished for buried piping systems (e. g. drainage channels). But there can also serve other basis for calculation, or results of research projects.

There is a software program for the surcharge calculation according to ATV-DVWK-A 127 at disposal in our technical engineering department in order to furnish the demanded proof. Please fill in the following questionnaire as completely as possible. We will promptly prepare a corresponding statics after receipt of the questionnaire.

Comments to some points of the questionnaire.

- Generally:  
These general statements are necessary to enable an assignment of the different projects.
- Details for pipe:  
Pipe material (polyethylene or polypropylene) and pipe dimensions must be specified here.
- Soil / Installation:  
There are four different groups of soil.

Group		Specific gravity $\gamma_B$ [kN/m <sup>3</sup> ]	gravity of internal friction $\phi'$	Deformation modulus $E_B$ in [N/mm <sup>2</sup> ] at degree of compaction $D_{pr}$ in %					
				$D_{pr}$					
				85	90	92	95	97	100
G1	non-cohesive soils (e.g. sand, gravel-/sand-mixtures)	20	35	2,0	6	9	16	23	40
G2	slightly cohesive soils (e.g. silts / silty sand and gravel mixtures)	20	30	1,2	3	4	8	11	20
G3	cohesive mixed soils, coarse clay (e.g. silty sand and gravel, cohesive stony residual soil)	20	25	0,8	2	3	5	8	13
G4	cohesive soils (e.g. clay)	20	20	0,6	1,5	2	4	6	10

Table D.7: Information soil types.

The at the calculation applied deformation modulus of the soil has to be distinguished by the following zones:

- $E_1$  Surcharge above pipe summit
- $E_2$  Pipe (embedment) zone around the pipe (min. 10cm)
- $E_3$  Native soil beside the pipe zone
- $E_4$  Native soil below the pipe



Abbildung D.1: Trench embedding condition

- Surcharge:  
The surcharge height is at the trench embedding condition the installation depth of the pipe (referring to the pipe summit) and at the dam embedding condition the waste surcharge.
- Operating conditions of the pipe:  
You only have to fill in the corresponding operating parameter for each application.

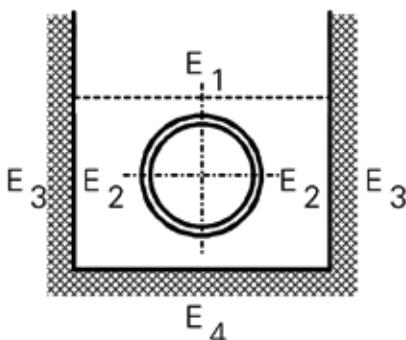

Abbildung D.2: Dam embedding condition

<b>1. Generally</b>	Project:	<input type="text"/>				
	Site:	<input type="text"/>				
	Principal:	<input type="text"/>				
<b>2. Details for pipe</b>	Pipe material:	<input type="text"/>	Pipe inside diameter:	<input type="text"/>	mm	
	Pipe outside diameter:	<input type="text"/>	mm	Wall thickness:	<input type="text"/>	mm
	Nominal width:	<input type="text"/>	mm			
<b>3. Soil</b>		Zone	E1	E2	E3	E4
	Group	G (1,2,3,4)	<input type="text"/>	<input type="text"/>	<input type="text"/>	<input type="text"/>
	Specific gravity	[kN/m <sup>3</sup> ]	<input type="text"/>	<input type="text"/>	<input type="text"/>	<input type="text"/>
	Proctor density	[%]	<input type="text"/>	<input type="text"/>	<input type="text"/>	<input type="text"/>
	E-Modulus of the soil $E_b$	[N/mm <sup>2</sup> ]	<input type="text"/>	<input type="text"/>	<input type="text"/>	<input type="text"/>
<b>4. Installation</b>	Method of laying:	Trench <input type="checkbox"/>	Dam <input type="checkbox"/>			
	Cover height (installation depth) from pipe crown to finished floor	$h =$ <input type="text"/>	mm	Trench width in pipe crown height $b =$ <input type="text"/>	m	
				Gradient of slope $\beta =$ <input type="text"/>	°	
<b>5. Surcharge</b>	Traffic load:	without <input type="checkbox"/>	LKW12 <input type="checkbox"/>	SLW30 <input type="checkbox"/>	SLW60 <input type="checkbox"/>	
	Additional weight on surface	$F =$ <input type="text"/>	[kN/m <sup>2</sup> ]			
	Minimum ground water level above pipe sole	<input type="text"/>	m			
	Maximum ground water level above pipe sole (m)	<input type="text"/>	m			
<b>6. Operating conditions of the pipe</b>	Operating temperature	$T =$ <input type="text"/>	[°C]			
	Operating pressure short time (24h)	$p =$ <input type="text"/>	[bar]			
	Operating pressure long time (50 years)	$p =$ <input type="text"/>	[bar]			

## 2.3 Trenchless installation

### 2.3.1 Horizontal directional drilling

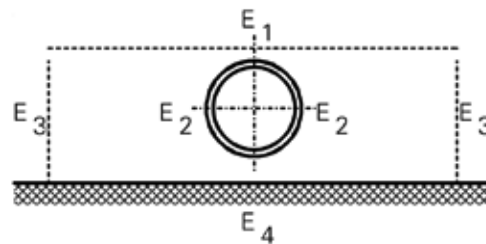
Horizontal directional drilling is a trenchless installation method where streets, rails, waters etc. are crossed underground. The installation of pipelines by means of horizontal directional drilling has 3 steps:

- **Primary drilling:**  
Beginning at the start pit, the driller is - under constant detection of the drilling head - drilling to the target pit. Due to the special geometry of the head as well as the drilling fluid at the drilling head it is possible to change direction.
- **Enlarging the drill hole:**  
For the enlarging of the drill hole the drilling head is replaced from the leverage in the target pit by a special widening-tool (back reamer). In reverse and rotating the back reamer is drawn back to the start pit.  
Depending on the pipe's dimension the process is repeated till the required drill hole diameter is reached.
- **Feeding the pipe:**  
The feeding in is done from the target to the start pit when widened the last time. An insertion head is mounted to the pipe. A transition piece prevents a rotation of the pipe. If requested, several pipes can be drawn in at once.

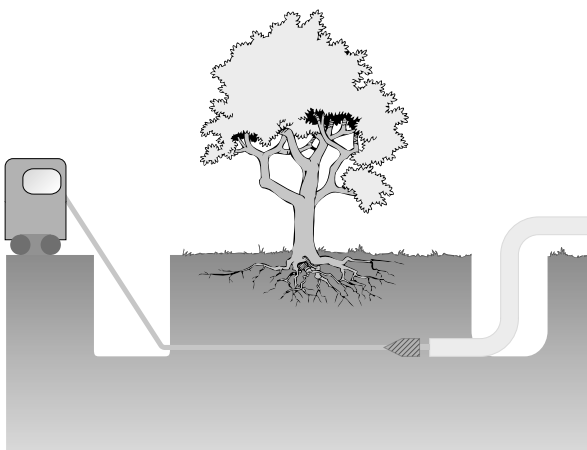

Figure D.4: Horizontal directional drilling.

## 2.4 Above ground installation

Pipes and pipelines made of thermoplastic polymers have changes in length due to temperature fluctuation. The following requirements for the installation of pipelines have to be considered.

### 2.4.1 Pipe support, mounting

Mountings or pipe clips for PE pipeline systems made out of different materials are available. Steel pipe clips should be equipped with bands made of PE or elastomers in order to protect the plastic pipe at length expansions.

Make sure that the pipe clips supporting area is as wide as possible to avoid punctual loads. The diameter should be adjusted to the pipe's outer diameter.

AGRU plastic pipe clips and pipe supports are especially suitable for installation due to the aligned tolerances of mountings and pipes. These pipe clips also work as e.g. slide bearings or guide bearings at horizontally installed pipelines, take vertically directed forces and hinder the pipeline from buckling. Stick to the support distances and the maximum guiding distance to prevent buckling. The support distances can be enlarged for pipes smaller OD 63 mm if the pipeline is supported with steel half-shells.

### 2.4.2 Anchoring

Expansions and contractions in radial and axial direction must not be hindered when installed above ground; i.e. building radial slackness, creating compensation loops, controlled length expansion due to reasonable positioning of anchors.

In general valves (for certain applications tees too) should be used as anchors within the pipeline. Advantageous are valve constructions, where the mounting mechanism is integrated in the valve. Electro fusion couplers in pipelines can also be used as anchors.

### 3 Relining

There are two ways of relining:

- Relining with annular space (Slip-lining)
- Relining without annular space (Close-fit-lining)

#### 3.1 Slip-lining

Standard PE pipes used for rehabilitation need to be smaller in diameter than the old pipe. On the one hand pipes with a length of several hundred metres can be used, e.g. coiled pipes. On the other hand singular pipes can be welded incrementally in the construction pit and afterwards be inserted into the old pipe.

Slip-lining leads to a reduction of the cross-section due to the annular space between new and old pipe. The reduced flow capacity can partially be compensated due to the good surface properties of PE. Nevertheless a capacity reduction has to be taken into account.

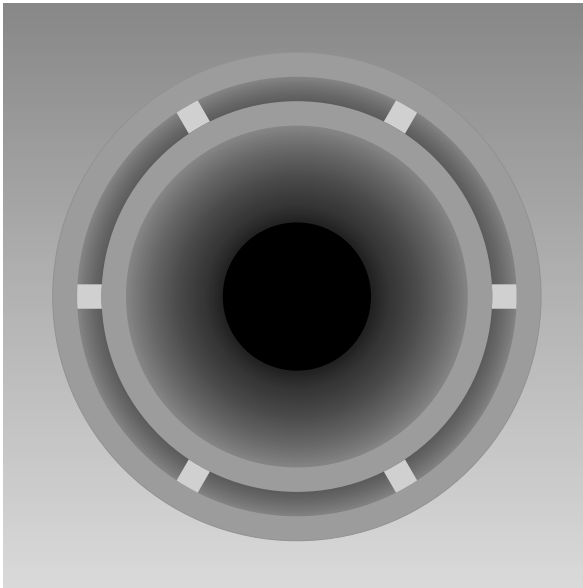

Figure D.5: Slip-lining.

#### 3.2 Close-fit-lining

During close-fit-lining - relining without annular space - a PE pipeline with reduced cross-section is inserted into the old pipe.



Figure D.6: SureFIT® during installation.

Once the pipe has been inserted into the existing old pipe, both ends are sealed. Then the pipe is heated up by using steam (water) and / or pressure.

This activates the memory effect. The treatment is continued until the pipe regains its original round shape and fits closely to the old pipe.

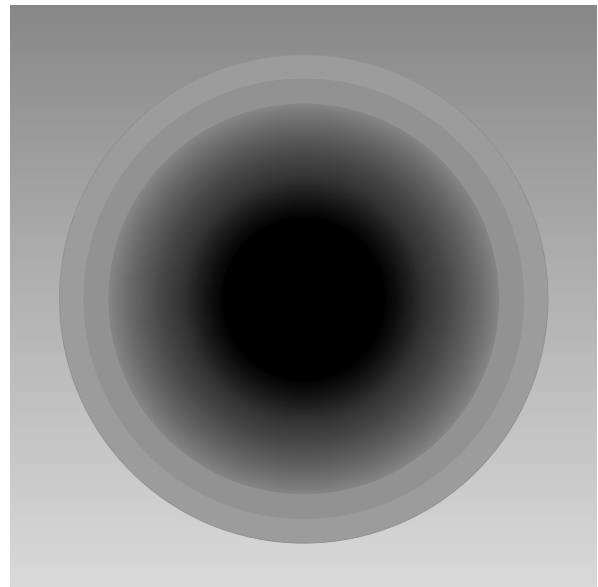

Figure D.7: SureFIT® after installation.



## 1 Marine Installation

115

Material properties

Calculation guide

Heated tool butt welding

Installation guide

Marine Installation



## 1 Marine Installation

### 1.1 AGRU large diameter pipe system for marine installations

A new high modern production plant allows the extrusion of up to 610 m (2001 FT) long pipe strings, with OD up to 3260, right into the sea. These strings save enormous labour costs during installation since no welding work is required at site. Thanks to their buoyancy in water, pipe strings can be towed by vessels directly on the site. This system offers you a cost efficient and easy installation for offshore applications and near shore projects. The main advantages of this system are:

#### 1.1.1 Fast and easy installation

Long pipe strings reduce the installation time

##### Up to 610 m (2001 FT) long floating pipe strings

- can be towed by vessels to the construction site worldwide
- less risk to be damaged during transport or installation
- require no welding joints and minimize the risk of bad welds
- supplied with flanges for quick connection
- remain perfectly round due to floating storage in the cool sea
- save storage area and heavy object manipulation on the land
- are available in dimensions up to OD 3260 mm



## 1.2 Marine installations

AGRU large diameter piping system is suitable for a lot of marine installations, e.g. power plants, desalination plants, transit pipelines and for further various marine applications of intake and outfall pipelines.

Since the early 1960's PE piping has been increasingly used for marine installations. The resistance against corrosion is a main reason for using PE. But further beneficial features like light weight, flexibility and ductility combine to make PE piping well-suited for these applications.

The weight of a PE pipe is around one tenth in comparison to a concrete pipe and less than one half of a cast iron pipe. So the handling of the pipes is easier and requires a minimum of heavy equipment.

Since the density of PE is about 96% of that of fresh water and about 94% of that of sea water, PE pipes float even when full of water. After final positioning of the pipe string, the air inside is replaced with water by opening valves at the closed pipe ends, so that the pipe sinks downwards.

The flexibility of PE pipes allows a controlled sinking process and on ground the pipe can be adapted to the natural topography of underwater surface. That means that the pipeline can be placed directly on the natural bottom without any trenching.



## 1.3 Float-and-Sink Method

The „S-bend installation method“, also known as „float and sink“, has been a fast and economical installation method since the 1960's.

In order to be able to provide a safety structural pipeline, the design and installation is comprised of the following basic steps:

- Selection of an appropriate pipe diameter.
- Selection of an appropriate SDR class in accordance with the right wall thickness.
- Selection of the design, weight and frequency of spacing of the ballast weights.
- Selection of an appropriate site for staging and joining the pipes (if short pipe strings are used).
- Preparing the land-to-water zone and, when required, the underwater bedding.
- Assembling of the individual lengths of pipe to a continuous pipe string (if short pipe strings are used).
- Mounting of the ballast weights and and launching towing of pipe into the water.
- Lowering of the pipe string on the provided installation area.



## 1.4 Sinking & ballasting

To ensure a safe installation of a PE pipe utilizing the S-bend sinking procedure, the bending radius must be closely monitored during the submersion process. The bending radius depends on the SDR ratio, the distance between the ballasting weights, the installation depth, the wave height during the submersion operation, the submersion speed and the pulling force applied on the floating end of the pipe.

The amount of the ballasting required depends on the height of the waves and current forces that may affect the pipe, and whether the pipeline is placed directly on the sea bed or in an open trench.

For pipes that are to be installed in trenches in the sea bed, the ballasting of the pipe is chosen with regard to the risk that the backfilling of the trench may affect the line and level of the pipes.

A PE pipe with concrete ballasts will in most cases, levels itself on the sea bed.

Two important requirements for concrete ballasts:

- The weights must be attached to the pipe that they can't slide on the pipe.
- The weights must be able to compensate the movements through the internal pressure in the pipe.



## 1.5 Trenching & backfilling

The load bearing capacity of PE pipes installed in trenches depends on the SDR ratio, the external load, material and compaction of the backfill material.

The method of installation of the backfill material should be chosen carefully to minimize the risk of internal material separation and that the backfill material completely surrounds the whole pipe.



## 1.6 Chlorination piping system

Chlorination of seawater intake systems is essential for a smooth operation and long term performance of the piping system. The chlorination for sea water intake pipes is mainly done by using sodium hypochlorite (NaOCl), due to the fact that the seawater itself carries all components necessary to produce sodium hypochlorite (sodium (Na), chlorine (Cl) and oxygen (O<sub>2</sub>)). The selection of the correct piping material, installation method and connection to the intake header are key elements for chlorination systems.

Piping systems made of high grade thermoplastics, such as PE 100-RC or ECTFE, as well as double containment piping systems made from these materials, offer significant improvements in performance, installation and safety during operation. The chemical resistance is the most important point and a criterion that must be absolutely fulfilled. Materials, which are used for chlorination systems, must be resistant to sea water on one side. On the other side there must be permanent resistance against sodium hypochlorite. ECTFE and PE 100 / PE 100-RC systems have already proven themselves in this area in an excellent way.

AGRU has a huge knowledge and is able to give most competent and reliable advice for projects, in which chlorine is present. AGRU is in contact with

engineering companies, consultants, agencies, installers and public authorities since many years and has collected a lot of extensive knowledge in the chlorination area. AGRU is using and will use the results of conducted studies to provide profound knowledge to customers for critical chemical projects like for chlorination systems, so that the risk for human beings and for the environment is minimized due to the fact that correct and suitable materials are used for such critical applications. AGRU can provide the right piping system for chlorination with diameters mainly in the range from OD20 mm up to OD110 mm, which are installed and fixed at the inside or at the outside of the seawater intake pipes.



## 1.7 AGRU services for design & installation

- SDR pipe calculations for PE pipes including deformation, stability & stress.
- Calculation pressure resistance of PE pipes.
- Calculation of statics for underground PE pipes according to ATV-DVWK-A 127.

AGRU together with their marine contractors are the best solution for a successful installation of a large diameter pipe system.





## Allgemeines

Sämtliche Angaben in diesem Lieferprogramm (Oktober 2019) sind nach dem derzeitigen Stand der Technik und bestem Wissen zusammengestellt.

Die Richtwerte in den Tabellen sind als Durchschnittswerte zu verstehen. Für Ihre speziellen Fragen stehen Ihnen unsere Anwendungstechniker kostenlos und unverbindlich zur Verfügung. Verbindlichkeiten in Bezug auf mögliche Abweichungen in Einzelfällen oder auch Rechte Dritter können nicht abgeleitet werden. Irrtum und Änderungen vorbehalten.

Zur Verbesserung und zur Angleichung an den Stand der Technik behalten wir uns maßgebliche und technische Änderungen vor.

Alle RAL- und sonstigen Farbangaben können technisch bedingte Schwankungen beinhalten.

Aktualisierungen finden Sie bitte unter [www.agru.at](http://www.agru.at).



## General Information

Any Information included in this Supply Program (October 2019) has been compiled in line with state-of-art technology and to the best of our knowledge.

The recommended values specified in the tables are to be considered as mean values. For your special questions please contact our application technology department free of charge and without obligation. We do not accept any liability for possible deviations in individual cases nor any claims of third parties. No liability is accepted for printing errors and amendments.

We reserve the right to make technical and dimensional improvements and updates without prior notice.

All RAL - and other colour-related specifications can contain production-related variations.

Please find the updated version on [www.agru.at](http://www.agru.at).

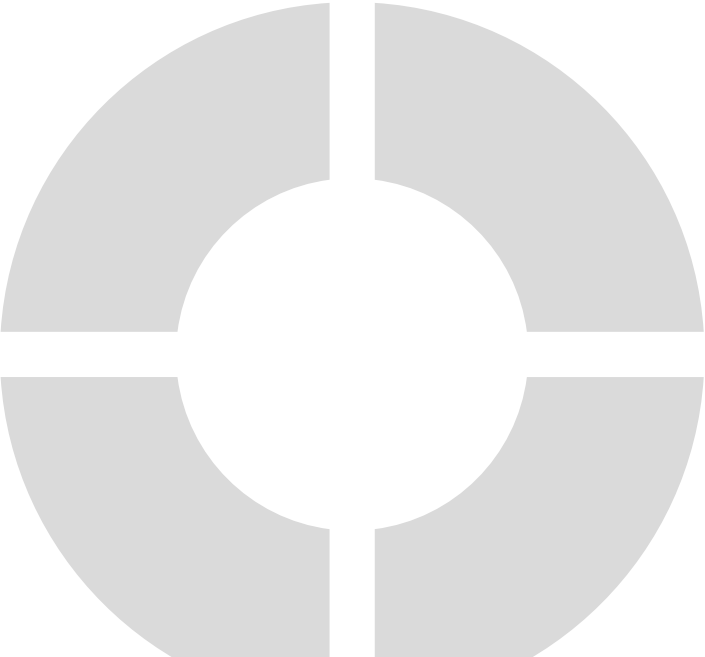



**XXL ROHRE**  
**XXL PIPES**



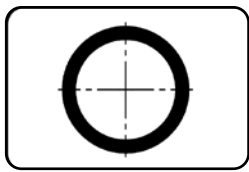

**ROHRE  
PIPES**
**Seite  
page**

Code: 705

**Rohr 5 m**
**Pipe 5 m**

 extrudiert  
PE 100 schwarz

 extruded  
PE 100 black

124

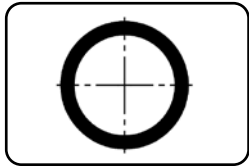

Code: 758

**Rohr 5,8 m**
**Pipe 5 m**

 extrudiert  
PE 100 schwarz

 extruded  
PE 100 black

125

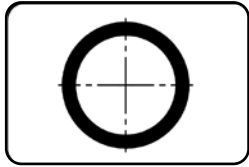

Code: 700

**Rohr 11,8 m**
**Pipe 11,8 m**

 extrudiert  
PE 100 schwarz

 extruded  
PE 100 black

127

**Rohr 5 m**  
extrudiert  
PE 100 schwarz

**Pipe 5 m**  
extruded  
PE 100 black

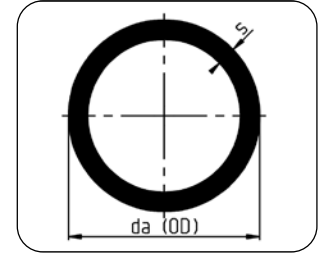
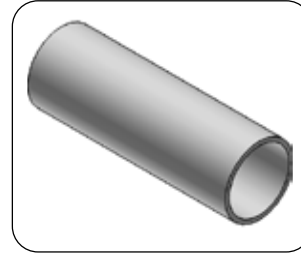
**Code 705**

Dimension	Code	Detail	da/OD [mm]	di/ID* [mm]	s [mm]	Gewicht/Weight [kg/m]
800	25.705.0800.41	800X19,6 SDR41 ISO S-20	800	758,6	19,6	48,70
900	25.705.0900.41	900X22,0 SDR41 ISO S-20	900	853,6	22,0	61,30
1000	25.705.1000.41	1000X24,5 SDR41 ISO S-20	1000	948,3	24,5	75,90
1200	25.705.1200.41	1200X29,4 SDR41 ISO S-20	1200	1138,0	29,4	109,00
1400	25.705.1400.41	1400X34,3 SDR41 ISO S-20	1400	1327,7	34,3	148,00
800	25.705.0800.33	800X24,5 SDR33 ISO S-16	800	748,3	24,5	60,40
900	25.705.0900.33	900X27,6 SDR33 ISO S-16	900	841,8	27,6	76,40
1000	25.705.1000.33	1000X30,6 SDR33 ISO S-16	1000	935,5	30,6	94,10
1200	25.705.1200.33	1200X36,7 SDR33 ISO S-16	1200	1122,7	36,7	135,00
1400	25.705.1400.33	1400X42,9 SDR33 ISO S-16	1400	1309,7	42,9	184,00
800	25.705.0800.26	800X30,6 SDR26 ISO S-12,5	800	735,5	30,6	75,00
900	25.705.0900.26	900X34,4 SDR26 ISO S-12,5	900	827,5	34,4	94,40
1000	25.705.1000.26	1000X38,2 SDR26 ISO S-12,5	1000	919,5	38,2	117,00
1200	25.705.1200.26	1200X45,9 SDR26 ISO S-12,5	1200	1103,4	45,9	168,00
1400	25.705.1400.26	1400X53,5 SDR26 ISO S-12,5	1400	1287,4	53,5	228,00
800	25.705.0800.21	800X38,1 SDR21 ISO S-10	800	719,7	38,1	92,00
900	25.705.0900.21	900X42,9 SDR21 ISO S-10	900	809,7	42,9	116,00
1000	25.705.1000.21	1000X47,7 SDR21 ISO S-10	1000	899,6	47,7	144,00
1200	25.705.1200.21	1200X57,2 SDR21 ISO S-10	1200	1079,6	57,2	207,00
1400	25.705.1400.21	1400X66,7 SDR21 ISO S-10	1400	1259,7	66,7	281,00
800	25.705.0800.17	800X47,4 SDR17 ISO S-8	800	700,2	47,4	113,00
900	25.705.0900.17	900X53,3 SDR17 ISO S-8	900	787,8	53,3	143,00
1000	25.705.1000.17	1000X59,3 SDR17 ISO S-8	1000	875,2	59,3	176,00
1200	25.705.1200.17	1200X71,1 SDR17 ISO S-8	1200	1050,4	71,1	254,00
1400	25.705.1400.17	1400X83,0 SDR17 ISO S-8	1400	1225,5	83,0	345,00
800	25.705.0800.11	800X72,6 SDR11 ISO S-5	800	647,3	72,6	167,00
900	25.705.0900.11	900X81,7 SDR11 ISO S-5	900	728,2	81,7	211,00
1000	25.705.1000.11	1000X90,8 SDR11 ISO S-5	1000	809,1	90,8	260,00
1200	25.705.1200.11	1200X108,9 SDR11 ISO S-5	1200	971,1	108,9	375,00
1400	25.705.1400.11	1400X127,0 SDR11 ISO S-5	1400	1133,1	127,0	510,00

\* Richtwert für mittleren Innendurchmesser (theoretisch)

\* Guide value for middle inner diameter (theoretical)

PE 100-RC auf Anfrage / PE 100-RC on request



**Rohr 5,8 m**  
extrudiert  
PE 100 schwarz

**Pipe 5,8 m**  
extruded  
PE 100 black

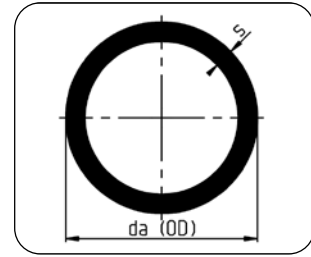
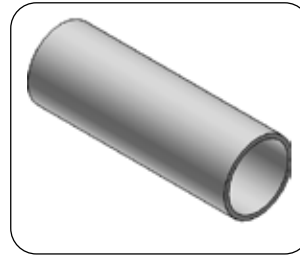
**Code 758**

Dimension	Code	Detail	da/OD [mm]	di/ID* [mm]	s [mm]	Gewicht/Weight [kg/m]
1600	25.758.1600.41	1600X39,2 SDR41 ISO S-20	1600	1517,4	39,2	194,00
1800	25.758.1800.41	1800X44,0 SDR41 ISO S-20	1800	1707,4	44,0	245,00
2000	25.758.2000.41	2000X48,9 SDR41 ISO S-20	2000	1897,1	48,9	302,00
2250	25.758.2250.41	2250X55,0 SDR41 ISO S-20	2250	2134,3	55,0	382,00
2300	25.758.2300.41	2300X56,3 SDR41 ISO S-20	2300	2181,5	56,3	400,40
2500	25.758.2500.41	2500X61,2 SDR41 ISO S-20	2500	2371,2	61,2	473,00
2720	25.758.2720.41	2720X66,5 SDR41 ISO S-20	2720	2580,1	66,5	559,00
2830	25.758.2830.41	2830X69,2 SDR41 ISO S-20	2830	2684,4	69,2	605,00
3000	25.758.3000.41	3000X73,4 SDR41 ISO S-20	3000	2845,6	73,4	680,00
3260	25.758.3260.41	3260X79,7 SDR41 ISO S-20	3260	3092,4	79,7	803,00
3500	25.758.3500.41	3500X85,6 SDR41 ISO S-20	3500	3320,0	85,6	925,00
1600	25.758.1600.33	1600X49,0 SDR33 ISO S-16	1600	1496,9	49,0	241,00
1800	25.758.1800.33	1800X55,1 SDR33 ISO S-16	1800	1684,0	55,1	305,00
2000	25.758.2000.33	2000X61,2 SDR33 ISO S-16	2000	1871,2	61,2	376,00
2250	25.758.2250.33	2250X68,9 SDR33 ISO S-16	2250	2105,1	68,9	476,00
2300	25.758.2300.33	2300X70,4 SDR33 ISO S-16	2300	2151,9	70,4	497,10
2500	25.758.2500.33	2500X76,5 SDR33 ISO S-16	2500	2339,1	76,5	587,00
2720	25.758.2720.33	2720X83,2 SDR33 ISO S-16	2720	2545,0	83,2	695,00
2830	25.758.2830.33	2830X86,6 SDR33 ISO S-16	2830	2647,9	86,6	752,00
3000	25.758.3000.33	3000X91,8 SDR33 ISO S-16	3000	2807,0	91,8	845,00
3260	25.758.3260.33	3260X99,7 SDR33 ISO S-16	3260	3050,4	99,7	997,00
3500	25.758.3500.33	3500X107,1 SDR33 ISO S-16	3500	3269,7	107,1	1.175,00
1600	25.758.1600.26	1600X61,2 SDR26 ISO S-12,5	1600	1471,2	61,2	298,00
1800	25.758.1800.26	1800X68,8 SDR26 ISO S-12,5	1800	1655,3	68,8	377,00
2000	25.758.2000.26	2000X76,4 SDR26 ISO S-12,5	2000	1839,3	76,4	465,00
2250	25.758.2250.26	2250X86,0 SDR26 ISO S-12,5	2250	2069,2	86,0	589,00
2300	25.758.2300.26	2300X87,9 SDR26 ISO S-12,5	2300	2115,2	87,9	615,20
2500	25.758.2500.26	2500X95,5 SDR26 ISO S-12,5	2500	2299,2	95,5	727,00
2720	25.758.2720.26	2720X103,9 SDR26 ISO S-12,5	2720	2501,6	103,9	859,00
2830	25.758.2830.26	2830X108,2 SDR26 ISO S-12,5	2830	2602,5	108,2	932,00
3000	25.758.3000.26	3000X114,6 SDR26 ISO S-12,5	3000	2759,1	114,6	1.046,00
3260	25.758.3260.26	3260X124,6 SDR26 ISO S-12,5	3260	2998,1	124,6	1.236,00
3500	25.758.3500.26	3500X133,7 SDR26 ISO S-12,5	3500	3212,5	133,7	1.455,60
1600	25.758.1600.21	1600X76,2 SDR21 ISO S-10	1600	1439,7	76,2	367,00
1800	25.758.1800.21	1800X85,8 SDR21 ISO S-10	1800	1619,6	85,8	465,00
2000	25.758.2000.21	2000X95,3 SDR21 ISO S-10	2000	1799,6	95,3	574,00
2250	25.758.2250.21	2250X107,2 SDR21 ISO S-10	2250	2024,6	107,2	726,00
2300	25.758.2300.21	2300X109,6 SDR21 ISO S-10	2300	2064,3	109,6	775,60

**Rohr 5,8 m**  
extrudiert  
PE 100 schwarz

**Pipe 5,8 m**  
extruded  
PE 100 black

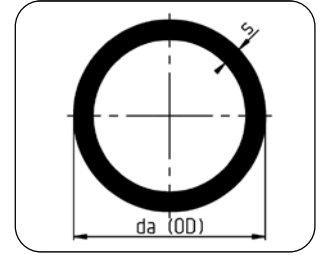
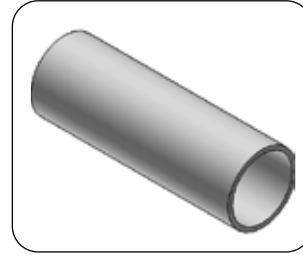
**Code 758**

Dimension	Code	Detail	da/OD [mm]	di/ID* [mm]	s [mm]	Gewicht/Weight [kg/m]
2500	25.758.2500.21	2500X119,1 SDR21 ISO S-10	2500	2249,6	119,1	897,00
2720	25.758.2720.21	2720X129,6 SDR21 ISO S-10	2720	2447,6	129,6	1061,00
2830	25.758.2830.21	2830X134,8 SDR21 ISO S-10	2830	2546,7	134,8	1148,00
3000	25.758.3000.21	3000X142,9 SDR21 ISO S-10	3000	2699,7	142,9	1291,00
1600	25.758.1600.17	1600X94,8 SDR17 ISO S-8	1600	1400,7	94,8	451,00
1800	25.758.1800.17	1800X106,6 SDR17 ISO S-8	1800	1575,9	106,6	571,00
2000	25.758.2000.17	2000X118,5 SDR17 ISO S-8	2000	1750,9	118,5	704,00
2250	25.758.2250.17	2250X133,3 SDR17 ISO S-8	2250	1969,8	133,3	892,00
2300	25.758.2300.17	2300X136,2 SDR17 ISO S-8	2300	2007,1	136,2	951,20
2500	25.758.2500.17	2500X148,1 SDR17 ISO S-8	2500	2188,7	148,1	1.101,00
1600	25.758.1600.11	1600X145,2 SDR11 ISO S-5	1600	1294,8	145,2	666,00

\* Richtwert für mittleren Innendurchmesser (theoretisch)

\* Guide value for middle inner diameter (theoretical)

PE 100-RC auf Anfrage / PE 100-RC on request

**Rohr 11,8 m**  
extrudiert  
PE 100 schwarz

**Pipe 11,8 m**  
extruded  
PE 100 black

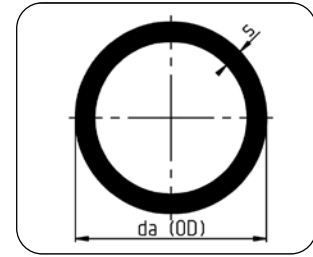
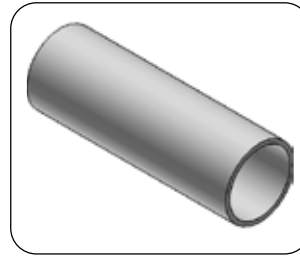
**Code 700**

Dimension	Code	Detail	da/OD [mm]	di/ID* [mm]	s [mm]	Gewicht/Weight [kg/m]
800	25.700.0800.41	800X19,6 SDR41 ISO S-20	800	758,6	19,6	48,70
900	25.700.0900.41	900X22,0 SDR41 ISO S-20	900	853,6	22,0	61,30
1000	25.700.1000.41	1000X24,5 SDR41 ISO S-20	1000	948,3	24,5	75,90
1200	25.700.1200.41	1200X29,4 SDR41 ISO S-20	1200	1138,0	29,4	109,00
1400	25.700.1400.41	1400X34,3 SDR41 ISO S-20	1400	1327,7	34,3	148,00
1600	25.700.1600.41	1600X39,2 SDR41 ISO S-20	1600	1517,4	39,2	194,00
1800	25.700.1800.41	1800X44,0 SDR41 ISO S-20	1800	1707,4	44,0	245,00
2000	25.700.2000.41	2000X48,9 SDR41 ISO S-20	2000	1897,1	48,9	302,00
2250	25.700.2250.41	2250X55,0 SDR41 ISO S-20	2250	2134,3	55,0	382,00
2300	25.700.2300.41	2300X56,3 SDR41 ISO S-20	2300	2181,5	56,3	400,40
2500	25.700.2500.41	2500X61,2 SDR41 ISO S-20	2500	2371,2	61,2	473,00
2720	25.700.2720.41	2720X66,5 SDR41 ISO S-20	2720	2580,1	66,5	559,00
2830	25.700.2830.41	2830X69,2 SDR41 ISO S-20	2830	2684,4	69,2	605,00
3000	25.700.3000.41	3000X73,4 SDR41 ISO S-20	3000	2845,6	73,4	680,00
3260	25.700.3260.41	3260X79,7 SDR41 ISO S-20	3260	3092,4	79,7	803,00
3500	25.700.3500.41	3500X85,6 SDR41 ISO S-20	3500	3320,0	85,6	925,00
800	25.700.0800.33	800X24,5 SDR33 ISO S-16	800	748,3	24,5	60,40
900	25.700.0900.33	900X27,6 SDR33 ISO S-16	900	841,8	27,6	76,40
1000	25.700.1000.33	1000X30,6 SDR33 ISO S-16	1000	935,5	30,6	94,10
1200	25.700.1200.33	1200X36,7 SDR33 ISO S-16	1200	1122,7	36,7	135,00
1400	25.700.1400.33	1400X42,9 SDR33 ISO S-16	1400	1309,7	42,9	184,00
1600	25.700.1600.33	1600X49,0 SDR33 ISO S-16	1600	1496,9	49,0	241,00
1800	25.700.1800.33	1800X55,1 SDR33 ISO S-16	1800	1684,0	55,1	305,00
2000	25.700.2000.33	2000X61,2 SDR33 ISO S-16	2000	1871,2	61,2	376,00
2250	25.700.2250.33	2250X68,9 SDR33 ISO S-16	2250	2105,1	68,9	476,00
2300	25.700.2300.33	2300X70,4 SDR33 ISO S-16	2300	2151,9	70,4	497,10
2500	25.700.2500.33	2500X76,5 SDR33 ISO S-16	2500	2339,1	76,5	587,00
2720	25.700.2720.33	2720X83,2 SDR33 ISO S-16	2720	2545,0	83,2	695,00
2830	25.700.2830.33	2830X86,6 SDR33 ISO S-16	2830	2647,9	86,6	752,00
3000	25.700.3000.33	3000X91,8 SDR33 ISO S-16	3000	2807,0	91,8	845,00
3260	25.700.3260.33	3260X99,7 SDR33 ISO S-16	3260	3050,4	99,7	997,00
3500	25.700.3500.33	3500X107,1 SDR33 ISO S-16	3500	3269,7	107,1	1.175,00
800	25.700.0800.26	800X30,6 SDR26 ISO S-12,5	800	735,5	30,6	75,00
900	25.700.0900.26	900X34,4 SDR26 ISO S-12,5	900	827,5	34,4	94,40
1000	25.700.1000.26	1000X38,2 SDR26 ISO S-12,5	1000	919,5	38,2	117,00
1200	25.700.1200.26	1200X45,9 SDR26 ISO S-12,5	1200	1103,4	45,9	168,00
1400	25.700.1400.26	1400X53,5 SDR26 ISO S-12,5	1400	1287,4	53,5	228,00
1600	25.700.1600.26	1600X61,2 SDR26 ISO S-12,5	1600	1471,2	61,2	298,00

**Rohr 11,8 m**  
extrudiert  
PE 100 schwarz

**Pipe 11,8 m**  
extruded  
PE 100 black

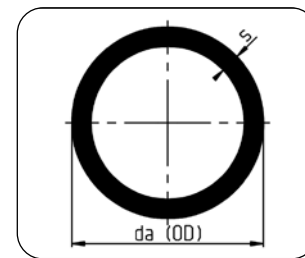
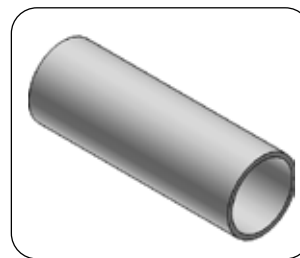

**Code 700**

Dimension	Code	Detail	da/OD [mm]	di/ID* [mm]	s [mm]	Gewicht/Weight [kg/m]
1800	25.700.1800.26	1800X68,8 SDR26 ISO S-12,5	1800	1655,3	68,8	377,00
2000	25.700.2000.26	2000X76,4 SDR26 ISO S-12,5	2000	1839,3	76,4	465,00
2250	25.700.2250.26	2250X86,0 SDR26 ISO S-12,5	2250	2069,2	86,0	589,00
2300	25.700.2300.26	2300X87,9 SDR26 ISO S-12,5	2300	2115,2	87,9	615,20
2500	25.700.2500.26	2500X95,5 SDR26 ISO S-12,5	2500	2299,2	95,5	727,00
2720	25.700.2720.26	2720X103,9 SDR26 ISO S-12,5	2720	2501,6	103,9	859,00
2830	25.700.2830.26	2830X108,2 SDR26 ISO S-12,5	2830	2602,5	108,2	932,00
3000	25.700.3000.26	3000X114,6 SDR26 ISO S-12,5	3000	2759,1	114,6	1.046,00
3260	25.700.3260.26	3260X124,6 SDR26 ISO S-12,5	3260	2998,1	124,6	1.236,00
3500	25.700.3500.26	3500X133,7 SDR26 ISO S-12,5	3500	3212,5	133,7	1.455,00
800	25.700.0800.21	800X38,1 SDR21 ISO S-10	800	719,7	38,1	92,00
900	25.700.0900.21	900X42,9 SDR21 ISO S-10	900	809,7	42,9	116,00
1000	25.700.1000.21	1000X47,7 SDR21 ISO S-10	1000	899,6	47,7	144,00
1200	25.700.1200.21	1200X57,2 SDR21 ISO S-10	1200	1079,6	57,2	207,00
1400	25.700.1400.21	1400X66,7 SDR21 ISO S-10	1400	1259,7	66,7	281,00
1600	25.700.1600.21	1600X76,2 SDR21 ISO S-10	1600	1439,7	76,2	367,00
1800	25.700.1800.21	1800X85,8 SDR21 ISO S-10	1800	1619,6	85,8	465,00
2000	25.700.2000.21	2000X95,3 SDR21 ISO S-10	2000	1799,6	95,3	574,00
2250	25.700.2250.21	2250X107,2 SDR21 ISO S-10	2250	2024,6	107,2	726,00
2300	25.700.2300.21	2300X109,6 SDR21 ISO S-10	2300	2064,3	109,6	775,60
2500	25.700.2500.21	2500X119,1 SDR21 ISO S-10	2500	2249,6	119,1	897,00
2720	25.700.2720.21	2720X129,6 SDR21 ISO S-10	2720	2447,6	129,6	1.061,00
2830	25.700.2830.21	2830X134,8 SDR21 ISO S-10	2830	2546,7	134,8	1.148,00
3000	25.700.3000.21	3000X142,9 SDR21 ISO S-10	3000	2699,7	142,9	1.291,00
800	25.700.0800.17	800X47,4 SDR17 ISO S-8	800	700,2	47,4	113,00
900	25.700.0900.17	900X53,3 SDR17 ISO S-8	900	787,8	53,3	143,00
1000	25.700.1000.17	1000X59,3 SDR17 ISO S-8	1000	875,2	59,3	176,00
1200	25.700.1200.17	1200X71,1 SDR17 ISO S-8	1200	1050,4	71,1	254,00
1400	25.700.1400.17	1400X83,0 SDR17 ISO S-8	1400	1225,5	83,0	345,00
1600	25.700.1600.17	1600X94,8 SDR17 ISO S-8	1600	1400,7	94,8	451,00
1800	25.700.1800.17	1800X106,6 SDR17 ISO S-8	1800	1575,9	106,6	571,00
2000	25.700.2000.17	2000X118,5 SDR17 ISO S-8	2000	1750,9	118,5	704,00
2250	25.700.2250.17	2250X133,3 SDR17 ISO S-8	2250	1969,8	133,3	892,00
2300	25.700.2300.17	2300X136,2 SDR17 ISO S-8	2300	2007,1	136,2	951,20
2500	25.700.2500.17	2500X148,1 SDR17 ISO S-8	2500	2188,7	148,1	1.101,00

XXL Rohre  
XXL pipes

Formteile  
Fittings

Flansche & Zubehör  
Flanges & Accessories

Schweißtechnik  
Welding Technology

**Rohr 11,8 m**  
extrudiert  
PE 100 schwarz

**Pipe 11,8 m**  
extruded  
PE 100 black

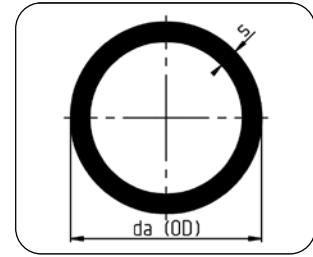
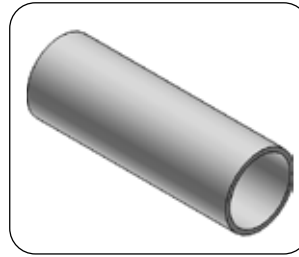
**Code 700**

Dimension	Code	Detail	da/OD [mm]	di/ID* [mm]	s [mm]	Gewicht/Weight [kg/m]
800	25.700.0800.11	800X72,6 SDR11 ISO S-5	800	647,3	72,6	167,00
900	25.700.0900.11	900X81,7 SDR11 ISO S-5	900	728,2	81,7	211,00
1000	25.700.1000.11	1000X90,8 SDR11 ISO S-5	1000	809,1	90,8	260,00
1200	25.700.1200.11	1200X108,9 SDR11 ISO S-5	1200	971,1	108,9	375,00
1400	25.700.1400.11	1400X127,0 SDR11 ISO S-5	1400	1133,1	127,0	510,00
1600	25.700.1600.11	1600X145,2 SDR11 ISO S-5	1600	1294,8	145,2	666,00

\* Richtwert für mittleren Innendurchmesser (theoretisch)

\* Guide value for middle inner diameter (theoretical)

PE 100-RC auf Anfrage / PE 100-RC on request

Sonderlängen auf Anfrage / special lengths on request



**FORMTEILE**  
**FITTINGS**

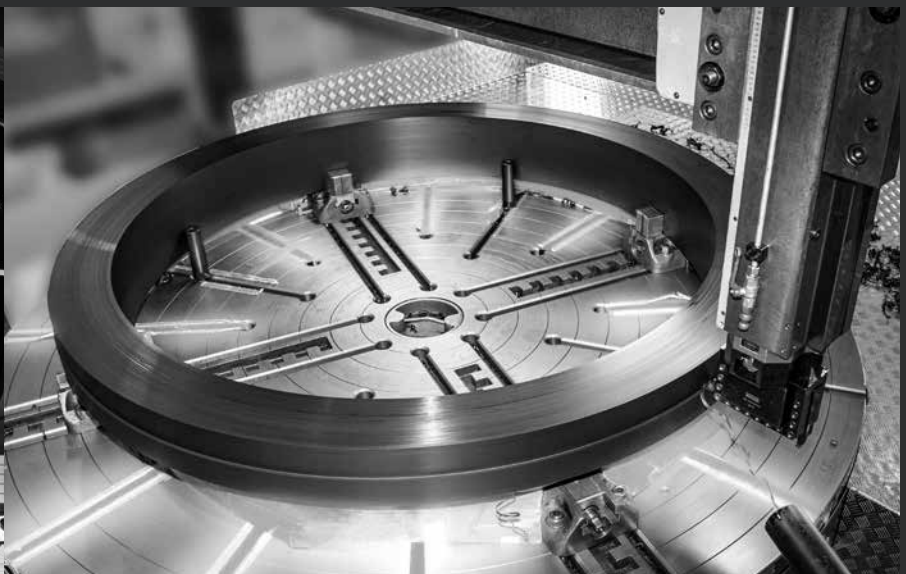





**KURZSCHENKELIGE FORMTEILE  
FITTINGS WITH SHORT SPIGOTS**

**Seite  
page**

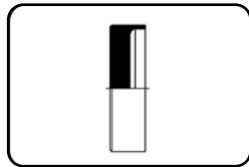

Code: 302

**Endkappe**  
kurze Schenkel  
mechanisch gefertigt  
PE 100 schwarz

**End cap**  
short spigot  
machined  
PE 100 black

135

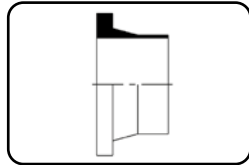

Code: 312

**Vorschweißbund DIN**  
kurze Schenkel  
mechanisch gefertigt  
PE 100 schwarz

**Stub Flange DIN**  
short spigot  
machined  
PE 100 black

136

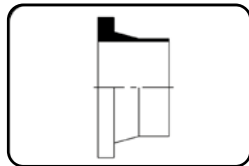

Code: 314

**Vorschweißbund ANSI**  
kurze Schenkel  
Mechanisch gefertigt  
PE 100 schwarz

**Stub Flange ANSI**  
short spigot  
machined  
PE 100 black

138

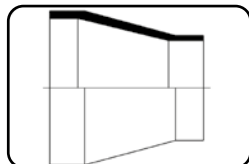

Code: 317

**Reduktion konzentrisch**  
kurze Schenkel  
mechanisch gefertigt  
PE 100 schwarz

**Reduction concentric**  
short spigot  
machined  
PE 100 black

140

**SEGMENTIERTE FORMTEILE  
SEGMENTED FITTINGS**

**Seite  
page**

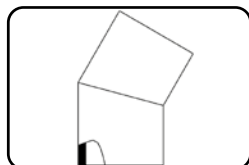

Code: 329

**Bogen 30°**  
segmentiert  
Abminderungsfaktor 0,8  
PE 100 schwarz

**Bend 30°**  
segmented  
reduced pressure rating 0,8  
PE 100 black

144

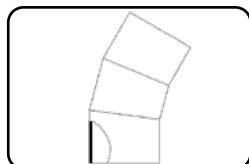

Code: 321

**Bogen 30°**  
segmentiert  
druckklassengerecht  
PE 100 schwarz

**Bend 30°**  
segmented  
full pressure rated  
PE 100 black

146

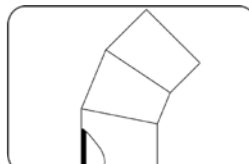

Code: 330

**Bogen 45°**  
segmentiert  
Abminderungsfaktor 0,8  
PE 100 schwarz

**Bend 45°**  
segmented  
reduced pressure rating 0,8  
PE 100 black

148

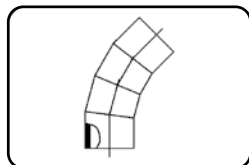

Code: 327

**Bogen 45°**  
segmentiert  
druckklassengerecht  
PE 100 schwarz

**Bend 45°**  
segmented  
full pressure rated  
PE 100 black

150

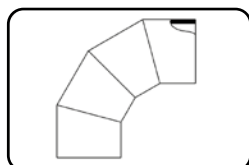

Code: 331

**Bogen 90°**  
segmentiert  
Abminderungsfaktor 0,8  
PE 100 schwarz

**Bend 90°**  
segmented  
reduced pressure rating 0,8  
PE 100 black

152

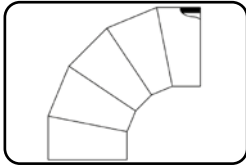

Code: 332

**Bogen 90°**  
segmentiert  
Abminderungsfaktor 0,8  
PE 100 schwarz

**Bend 90°**  
segmented  
reduced pressure rating 0,8  
PE 100 black

153

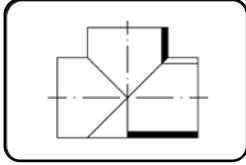

Code: 326

**T-Stück**  
segmentiert  
Abminderungsfaktor 0,6  
PE 100 schwarz

**Tee**  
segmented  
reduced pressure rating 0,6  
PE 100 black

155

**REDUZIERTER T-STÜCKE**  
**REDUCED TEES**

**Seite**  
**page**

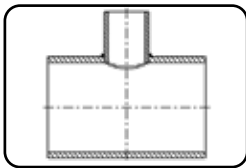

Code: 308

**T-Stück reduziert**  
geschweißt  
druckreduziert  
PE 100 schwarz

**Tee reduced**  
welded  
pressure reduced  
PE 100 black

157

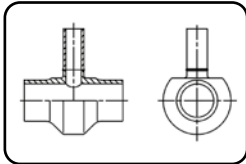

Code: 307

**T-Stück reduziert**  
stumpf geschweißt  
druckklassengerecht  
PE 100 schwarz

**Tee reduced**  
butt welded  
full pressure rated  
PE 100 black

169

**E-MUFFE**  
**E-COUPLER**

**Seite**  
**page**



Code: 373

**E-Muffe**  
formgeschweißt  
PE 100 schwarz

**E-Coupler**  
injection moulded  
PE 100 black

174

**STUTZENSCHELLE SYSTEM „TOPLOAD“**  
**SPIGOT SADDLE SYSTEM „TOPLOAD“**

**Seite**  
**page**

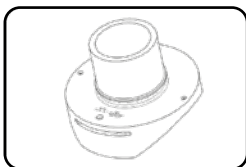

Code: 289

**Stutzenschelle**  
mechanisch gefertigt  
PE 100 schwarz

**Spigot Saddle**  
machined  
PE 100 black

175

**Endkappe**  
kurze Schenkel  
mechanisch gefertigt  
PE 100 schwarz

**End cap**  
short spigot  
machined  
PE 100 black

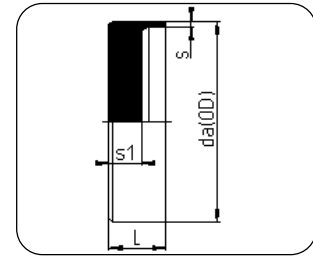
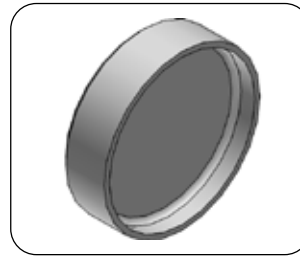

**Code 302**

Dimension	Code	Detail	da (OD) [mm]	s [mm]	L [mm]	s1 [mm]	Gewicht/Weight [kg/m]
800	25.302.0800.41	800 SDR41 ISO S-20	800	19,6	100,0	75,0	30,90
900	25.302.0900.41	900 SDR41 ISO S-20	900	22,0	110,0	80,0	41,30
1000	25.302.1000.41	1000 SDR41 ISO S-20	1000	24,5	120,0	90,0	57,10
1200	25.320.1200.41	1200 SDR41 ISO S-20	1200	29,4	130,0	100,0	96,00
800	25.302.0800.33	800 SDR33 ISO S-16	800	24,5	100,0	75,0	31,30
900	25.302.0900.33	900 SDR33 ISO S-16	900	27,6	110,0	80,0	43,80
1000	25.302.1000.33	1000 SDR33 ISO S-16	1000	30,6	120,0	90,0	60,20
1200	25.302.1200.33	1200 SDR33 ISO S-16	1200	36,7	130,0	100,0	100,00
800	25.302.0800.26	800 SDR26 ISO S-12,5	800	30,6	110,0	85,0	36,50
900	25.302.0900.26	900 SDR26 ISO S-12,5	900	34,4	120,0	90,0	48,60
1000	25.302.1000.26	1000 SDR26 ISO S-12,5	1000	38,2	120,0	90,0	63,20
1200	25.302.1200.26	1200 SDR26 ISO S-12,5	1200	45,9	140,0	110,0	112,00
800	25.302.0800.21	800 SDR21 ISO S-10	800	38,1	110,0	85,0	37,80
900	25.302.0900.21	900 SDR21 ISO S-10	900	42,9	120,0	95,0	53,80
1000	25.302.1000.21	1000 SDR21 ISO S-10	1000	47,7	120,0	95,0	68,20
1200	25.302.1200.21	1200 SDR21 ISO S-10	1200	57,2	140,0	110,0	116,00
800	25.302.0800.17	800 SDR17 ISO S-8	800	47,4	143,0	117,0	47,70
900	25.302.0900.17	900 SDR17 ISO S-8	900	53,3	150,0	122,0	63,90
1000	25.302.1000.17	1000 SDR17 ISO S-8	1000	59,3	170,0	140,0	88,70
1200	25.302.1200.17	1200 SDR17 ISO S-8	1200	71,1	200,0	170,0	165,00
800	25.302.0800.11	800 SDR11 ISO S-5	800	72,6	164,0	134,0	59,40
900	25.302.0900.11	900 SDR11 ISO S-5	900	81,7	182,0	152,0	85,00
1000	25.302.1000.11	1000 SDR11 ISO S-5	1000	90,8	200,0	170,0	117,80
1200	25.302.1200.11	1200 SDR11 ISO S-5	1200	108,9	240,0	210,0	201,00

Verlängerungen auf Anfrage möglich / Elongations available on request.

**Vorschweißbund DIN**  
kurze Schenkel  
mechanisch gefertigt  
Stumpfschweißung  
PE 100 schwarz

**Stub flange DIN**  
short spigot  
machined  
butt welding  
PE 100 black

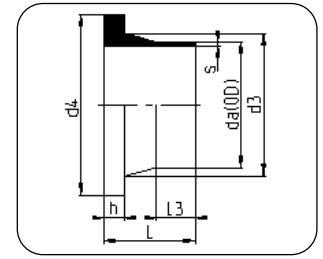

**Code 312**

Dimen- sion	Code	Detail	da/OD [mm]	s [mm]	L [mm]	L3 [mm]	d3 [mm]	d4 [mm]	h [mm]	Gewicht/Weight [kg/m]
800	25.312.0800.41	800X19,6 SDR41 ISO S-20	800	19,6	120,0	25,0	840	905	50	11,00
900	25.312.0900.41	900X22,0 SDR41 ISO S-20	900	22,0	130,0	25,0	944	1005	55	16,00
1000	25.312.1000.41	1000X24,5 SDR41 ISO S-20	1000	24,5	140,0	60,0	1047	1110	60	21,00
1200	25.312.1200.41	1200X29,4 SDR41 ISO S-20	1200	29,4	160,0	60,0	1245	1330	70	34,00
1400	25.312.1400.41	1400X34,3 SDR41 ISO S-20	1400	34,3	180,0	40,0	1425	1535	80	51,00
1600	25.312.1600.41	1600X39,2 SDR41 ISO S-20	1600	39,2	195,0	40,0	1655	1760	95	88,00
1800	25.312.1800.41	1800X44,0 SDR41 ISO S-20	1800	44,0	210,0	45,0	1860	1960	110	102,00
2000	25.312.2000.41	2000X48,9 SDR41 ISO S-20	2000	48,9	230,0	50,0	2070	2170	130	153,00
2250	25.312.2250.41	2250X55,0 SDR41 ISO S-20	2250	55,0	250,0	50,0	2320	2435	150	216,00
2300	25.314.2300.41	2300X56,3 SDR41 ISO S-20	2300	56,3	250,0	60,0	2370	2520	160	325,00
2500	25.312.2500.41	2500X61,2 SDR41 ISO S-20	2500	61,2	275,0	60,0	2550	2730	165	277,00
2720	25.312.2720.41	2720X66,5 SDR41 ISO S-20	2720	66,5	320,0	60,0	2800	2990	180	390,00
2830	25.312.2830.41	2830X69,2 SDR41 ISO S-20	2830	69,2	330,0	60,0	2880	3080	190	413,00
3000	25.312.3000.41	3000X73,4 SDR41 ISO S-20	3000	73,4	340,0	60,0	3080	3220	200	437,00
3500	25.312.3500.41	3500X85,6 SDR41 ISO S-20	3500	85,6	450	100	3600	3920	240	961,00
800	25.312.0800.33	800X24,5 SDR33 ISO S-16	800	24,5	120,0	25,0	840	905	50	12,30
900	25.312.0900.33	900X27,6 SDR33 ISO S-16	900	27,6	130,0	25,0	944	1005	55	19,00
1000	25.312.1000.33	1000X30,6 SDR33 ISO S-16	1000	30,6	140,0	30,0	1047	1110	60	22,00
1200	25.312.1200.33	1200X36,7 SDR33 ISO S-16	1200	36,7	160,0	30,0	1245	1330	70	39,00
1400	25.312.1400.33	1400X42,9 SDR33 ISO S-16	1400	42,9	180,0	40,0	1425	1535	80	53,00
1600	25.312.1600.33	1600X49,0 SDR33 ISO S-16	1600	49,0	195,0	40,0	1655	1760	95	101,00
1800	25.312.1800.33	1800X55,1 SDR33 ISO S-16	1800	55,1	210,0	45,0	1860	1960	110	109,00
2000	25.312.2000.33	2000X61,2 SDR33 ISO S-16	2000	61,2	230,0	50,0	2070	2170	130	144,00
2250	25.312.2250.33	2250X68,9 SDR33 ISO S-16	2250	68,9	250,0	50,0	2320	2435	150	226,00
2300	25.312.2300.33	2300X70,4 SDR33 ISO S-16	2300	70,4	250,0	60,0	2435	2435	150	330,00
2500	25.312.2500.33	2500X76,5 SDR33 ISO S-16	2500	76,5	275,0	60,0	2550	2730	165	307,00
2720	25.312.2720.33	2720X83,2 SDR33 ISO S-16	2720	83,2	320,0	60,0	2800	2990	180	431,00
2830	25.312.2830.33	2830X86,6 SDR33 ISO S-16	2830	86,6	330,0	60,0	2880	3080	190	464,00
3000	25.312.3000.33	3000X91,8 SDR33 ISO S-16	3000	91,8	340,0	60,0	3080	3220	200	491,00
3500	25.312.3500.33	3500X107,1 SDR33 ISO S-16	3500	107,1	450	100	3600	3920	240	1.060,00
800	25.312.0800.26	800X30,6 SDR26 ISO S-12,5	800	30,6	125,0	25,0	840	905	55	15,00
900	25.312.0900.26	900X34,4 SDR26 ISO S-12,5	900	34,4	135,0	25,0	944	1005	60	21,20
1000	25.312.1000.26	1000X38,2 SDR26 ISO S-12,5	1000	38,2	145,0	30,0	1047	1110	65	28,90
1200	25.312.1200.26	1200X45,9 SDR26 ISO S-12,5	1200	45,9	165,0	30,0	1245	1330	75	46,60
1400	25.312.1400.26	1400X53,5 SDR26 ISO S-12,5	1400	53,5	185,0	40,0	1425	1535	85	63,20
1600	25.312.1600.26	1600X61,2 SDR26 ISO S-12,5	1600	61,2	200,0	40,0	1655	1760	100	143,00
1800	25.312.1800.26	1800X68,8 SDR26 ISO S-12,5	1800	68,8	225,0	45,0	1860	1960	125	141,00
2000	25.312.2000.26	2000X76,4 SDR26 ISO S-12,5	2000	76,4	240,0	50,0	2070	2170	140	183,50
2250	25.312.2250.26	2250X86,0 SDR26 ISO S-12,5	2250	86,0	255,0	50,0	2320	2435	155	249,00

**Vorschweißbund DIN**  
kurze Schenkel  
mechanisch gefertigt  
Stumpfschweißung  
PE 100 schwarz

**Stub flange DIN**  
short spigot  
machined  
butt welding  
PE 100 black

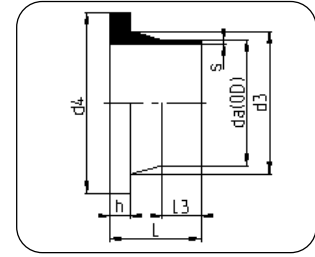

**Code 312**

Dimen- sion	Code	Detail	da/OD [mm]	s [mm]	L [mm]	L3 [mm]	d3 [mm]	d4 [mm]	h [mm]	Gewicht/Weight [kg/m]
2300	25.312.2300.26	2300X87,9 SDR26 ISO S-12,5	2300	87,9	250,0	60,0	2435	2435	150	405,00
2500	25.312.2500.26	2500X95,5 SDR26 ISO S-12,5	2500	95,5	285,0	60,0	2550	2730	175	359,00
2720	25.312.2720.26	2720X103,9 SDR26 ISO S-12,5	2720	103,9	330,0	60,0	2800	2990	190	502,00
2830	25.312.2830.26	2830X108,2 SDR26 ISO S-12,5	2830	108,2	340,0	60,0	2880	3080	200	544,00
3000	25.312.3000.26	3000X114,6 SDR26 ISO S-12,5	3000	114,6	350,0	60,0	3080	3220	210	577,00
3500	25.312.3500.26	3500X133,7 SDR26 ISO S-12,5	3500	133,7	450	100	3600	3920	250	1.219,00
800	25.312.0800.21	800X38,1 SDR21 ISO S-10	800	38,1	140,0	30,0	840	905	65	21,90
900	25.312.0900.21	900X42,9 SDR21 ISO S-10	900	42,9	150,0	30,0	944	1005	70	28,20
1000	25.312.1000.21	1000X47,7 SDR21 ISO S-10	1000	47,7	160,0	35,0	1047	1110	75	36,30
1200	25.312.1200.21	1200X57,2 SDR21 ISO S-10	1200	57,2	185,0	35,0	1245	1330	90	50,00
1400	25.312.1400.21	1400X66,7 SDR21 ISO S-10	1400	66,7	200,0	45,0	1425	1535	100	73,00
1600	25.312.1600.21	1600X76,2 SDR21 ISO S-10	1600	76,2	210,0	45,0	1655	1760	110	99,40
1800	25.312.1800.21	1800X85,8 SDR21 ISO S-10	1800	85,8	225,0	50,0	1860	1960	125	142,00
2000	25.312.2000.21	2000X95,3 SDR21 ISO S-10	2000	95,3	240,0	50,0	2070	2170	140	221,00
2250	25.312.2250.21	2250X107,2 SDR21 ISO S-10	2250	107,2	260,0	50,0	2320	2435	160	267,00
2300	25.312.2300.21	2300X109,6 SDR21 ISO S-10	2300	109,6	250,0	60,0	2435	2435	150	440,00
2500	25.312.2500.21	2500X119,1 SDR21 ISO S-10	2500	119,1	285,0	60,0	2550	2730	175	406,00
2720	25.312.2720.21	2720X129,6 SDR21 ISO S-10	2720	129,6	330,0	60,0	2800	2990	190	565,00
2830	25.312.2830.21	2830X134,8 SDR21 ISO S-10	2830	134,8	340,0	60,0	2880	3080	200	621,00
3000	25.312.3000.21	3000X142,9 SDR21 ISO S-10	3000	142,9	350,0	60,0	3080	3220	210	658,00
800	25.312.0800.17	800X47,4 SDR17 ISO S-8	800	47,4	140,0	30,0	840	905	65	24,70
900	25.312.0900.17	900X53,3 SDR17 ISO S-8	900	53,3	150,0	30,0	944	1005	70	31,90
1000	25.312.1000.17	1000X59,3 SDR17 ISO S-8	1000	59,3	160,0	35,0	1047	1110	75	41,30
1200	25.312.1200.17	1200X71,1 SDR17 ISO S-8	1200	71,1	185,0	35,0	1245	1330	90	69,00
1400	25.312.1400.17	1400X83,0 SDR17 ISO S-8	1400	83,0	200,0	45,0	1425	1535	100	82,00
1600	25.312.1600.17	1600X94,8 SDR17 ISO S-8	1600	94,8	210,0	45,0	1655	1760	110	138,00
1800	25.312.1800.17	1800X106,6 SDR17 ISO S-8	1800	106,6	225,0	50,0	1860	1960	125	182,00
2000	25.312.2000.17	2000X118,5 SDR17 ISO S-8	2000	118,5	240,0	50,0	2070	2170	140	204,00
2250	25.312.2250.17	2250X133,3 SDR17 ISO S-8	2250	133,3	260,0	50,0	2320	2435	160	330,00
2500	25.312.2500.17	2500X148,1 SDR17 ISO S-8	2500	148,1	285,0	60,0	2550	2730	175	461,00
800	25.312.0800.11	800X72,6 SDR11 ISO S-5	800	72,6	150,0	40,0	840	905	70	34,10
900	25.312.0900.11	900X81,7 SDR11 ISO S-5	900	81,7	160,0	35,0	944	1005	75	44,60
1000	25.312.1000.11	1000X90,8 SDR11 ISO S-5	1000	90,8	170,0	40,0	1047	1110	80	57,60
1200	25.312.1200.11	1200X108,9 SDR11 ISO S-5	1200	108,9	195,0	40,0	1245	1330	95	68,00
1400	25.312.1400.11	1400X127,0 SDR11 ISO S-5	1400	127,0	205,0	50,0	1425	1535	105	107,00
1600	25.312.1600.11	1600X145,2 SDR11 ISO S-5	1600	145,2	215,0	50,0	1655	1760	115	133,00

Verlängerungen auf Anfrage möglich / Elongations available on request.

für DIN Flanschverbindung gem. DIN EN1092-1 / for DIN flange connection acc. DIN EN1092-1

**Vorschweißbund ANSI**

kurze Schenkel  
Mechanisch gefertigt  
PE 100 schwarz

**Stub Flange ANSI**

short spigot  
machined  
PE 100 black

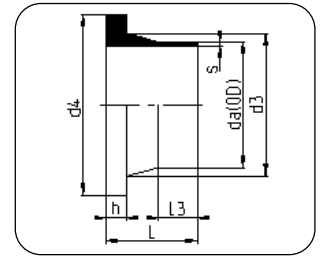

**Code 314**

Dimension [mm]	Dimension [inch]	Code	Detail	da/OD [mm]	s [mm]	L [mm]	L3 [mm]	d3 [mm]	d4 [mm]	h [mm]	Gewicht/Weight [kg/m]
800	32	25.314.0800.41	800X19,6 SDR41 ISO S-20	800	19,6	120,0	25,0	840	930	50	14,00
900	36	25.314.0900.41	900X22,0 SDR41 ISO S-20	900	22,0	130,0	25,0	944	1040	55	19,00
1000	40	25.314.1000.41	1000X24,5 SDR41 ISO S-20	1000	24,5	140,0	60,0	1047	1150	60	35,00
1200	48	25.314.1200.41	1200X29,4 SDR41 ISO S-20	1200	29,4	160,0	60,0	1245	1375	70	41,00
1400	54	25.314.1400.41	1400X34,3 SDR41 ISO S-20	1400	34,3	180,0	40,0	1450	1540	80	55,00
1600	66	25.314.1600.41	1600X39,2 SDR41 ISO S-20	1600	39,2	195,0	40,0	1655	1875	95	109,00
1800	72	25.314.1800.41	1800X44,0 SDR41 ISO S-20	1800	44,0	210,0	45,0	1860	2040	110	133,00
2000	78	25.314.2000.41	2000X48,9 SDR41 ISO S-20	2000	48,9	230,0	50,0	2070	2195	130	174,00
2250	90	25.314.2250.41	2250X55,0 SDR41 ISO S-20	2250	55,0	250,0	50,0	2350	2520	150	274,00
2300	91	25.314.2300.41	2300X56,3 SDR41 ISO S-20	2300	56,3	250,0	60,0	2370	2520	160	325,00
2500	102	25.314.2500.41	2500X61,2 SDR41 ISO S-20	2500	61,2	275,0	60,0	2550	2830	165	346,00
2720	108	25.314.2720.41	2720X66,5 SDR41 ISO S-20	2720	66,5	320,0	60,0	2800	2970	180	374,00
2830	114	25.314.2830.41	2830X69,2 SDR41 ISO S-20	2830	69,2	330,0	60,0	2880	3130	190	441,00
3000	120	25.314.3000.41	3000X73,4 SDR41 ISO S-20	3000	73,4	340,0	60,0	3080	3270	200	486,00
3260	132	25.314.3260.41	3260X79,7 SDR41 ISO S-20	3260	79,7	390,0	100,0	3350	3600	220	708,00
800	32	25.314.0800.33	800X24,5 SDR33 ISO S-16	800	24,5	120,0	25,0	840	930	50	15,00
900	36	25.314.0900.33	900X27,6 SDR33 ISO S-16	900	27,6	130,0	25,0	944	1040	55	20,00
1000	40	25.314.1000.33	1000X30,6 SDR33 ISO S-16	1000	30,6	140,0	30,0	1047	1150	60	27,00
1200	48	25.314.1200.33	1200X36,7 SDR33 ISO S-16	1200	36,7	160,0	30,0	1245	1375	70	43,00
1400	54	25.314.1400.33	1400X42,9 SDR33 ISO S-16	1400	42,9	180,0	40,0	1450	1540	80	58,00
1600	66	25.314.1600.33	1600X49,0 SDR33 ISO S-16	1600	49,0	195,0	40,0	1655	1875	95	113,00
1800	72	25.314.1800.33	1800X55,1 SDR33 ISO S-16	1800	55,1	210,0	45,0	1860	2040	110	139,00
2000	78	25.314.2000.33	2000X61,2 SDR33 ISO S-16	2000	61,2	230,0	50,0	2070	2195	130	181,00
2250	90	25.314.2250.33	2250X68,9 SDR33 ISO S-16	2250	68,9	250,0	50,0	2350	2520	150	285,00
2300	91	25.314.2300.33	2300X70,4 SDR33 ISO S-16	2300	70,4	250,0	60,0	2370	2520	160	335,00
2500	102	25.314.2500.33	2500X76,5 SDR33 ISO S-16	2500	76,5	275,0	60,0	2550	2830	165	376,00
2720	108	25.314.2720.33	2720X83,2 SDR33 ISO S-16	2720	83,2	320,0	60,0	2800	2970	180	415,00
2830	114	25.314.2830.33	2830X86,6 SDR33 ISO S-16	2830	86,6	330,0	60,0	2880	3130	190	441,00
3000	120	25.314.3000.33	3000X91,8 SDR33 ISO S-16	3000	91,8	340,0	60,0	3080	3270	200	540,00
3260	132	25.314.3260.33	3260X99,7 SDR33 ISO S-16	3260	99,7	390,0	100,0	3350	3600	220	780,00
800	32	25.314.0800.26	800X30,6 SDR26 ISO S-12,5	800	30,6	125,0	25,0	840	930	55	17,00
900	36	25.314.0900.26	900X34,4 SDR26 ISO S-12,5	900	34,4	135,0	25,0	944	1040	60	23,00
1000	40	25.314.1000.26	1000X38,2 SDR26 ISO S-12,5	1000	38,2	145,0	30,0	1047	1150	65	30,00
1200	48	25.314.1200.26	1200X45,9 SDR26 ISO S-12,5	1200	45,9	165,0	30,0	1245	1375	75	53,60
1400	54	25.314.1400.26	1400X53,5 SDR26 ISO S-12,5	1400	53,5	185,0	40,0	1450	1540	85	65,10
1600	66	25.314.1600.26	1600X61,2 SDR26 ISO S-12,5	1600	61,2	200,0	40,0	1655	1875	100	134,00
1800	72	25.314.1800.26	1800X68,8 SDR26 ISO S-12,5	1800	68,8	225,0	45,0	1860	2040	125	163,00
2000	78	25.314.2000.26	2000X76,4 SDR26 ISO S-12,5	2000	76,4	240,0	50,0	2070	2195	140	204,00
2250	90	25.314.2250.26	2250X86,0 SDR26 ISO S-12,5	2250	86,0	255,0	50,0	2350	2520	155	299,00



**Vorschweißbund ANSI**  
kurze Schenkel  
Mechanisch gefertigt  
PE 100 schwarz

**Stub Flange ANSI**  
short spigot  
machined  
PE 100 black

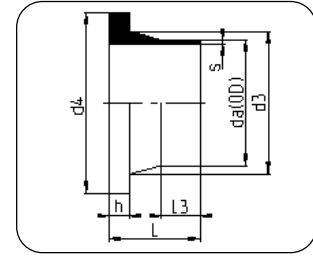

**Code 314**

Dimension [mm]	Dimension [inch]	Code	Detail	da/OD [mm]	s [mm]	L [mm]	L3 [mm]	d3 [mm]	d4 [mm]	h [mm]	Gewicht/Weight [kg/m]
2300	91	25.314.2300.26	2300X87,9 SDR26 ISO S-12,5	2300	87,9	250,0	60,0	2370	2520	160	410,00
2500	102	25.314.2500.26	2500X95,5 SDR26 ISO S-12,5	2500	95,5	285,0	60,0	2550	2830	175	433,00
2720	108	25.314.2720.26	2720X103,9 SDR26 ISO S-12,5	2720	103,9	330,0	60,0	2800	2970	190	485,00
2830	114	25.314.2830.26	2830X108,2 SDR26 ISO S-12,5	2830	108,2	340,0	60,0	2880	3130	200	573,00
3000	120	25.314.3000.26	3000X114,6 SDR26 ISO S-12,5	3000	114,6	350,0	60,0	3080	3270	210	628,00
3260	132	25.314.3260.26	3260X124,6 SDR26 ISO S-12,5	3260	124,6	400,0	100,0	3350	3600	230	897,00
800	32	25.314.0800.21	800X38,1 SDR21 ISO S-10	800	38,1	140,0	30,0	840	930	65	21,00
900	36	25.314.0900.21	900X42,9 SDR21 ISO S-10	900	42,9	150,0	30,0	944	1040	70	30,10
1000	40	25.314.1000.21	1000X47,7 SDR21 ISO S-10	1000	47,7	160,0	35,0	1047	1150	75	36,00
1200	48	25.314.1200.21	1200X57,2 SDR21 ISO S-10	1200	57,2	185,0	35,0	1245	1375	90	68,70
1400	54	25.314.1400.21	1400X66,7 SDR21 ISO S-10	1400	66,7	200,0	45,0	1450	1540	100	100,00
1600	66	25.314.1600.21	1600X76,2 SDR21 ISO S-10	1600	76,2	210,0	45,0	1655	1875	110	414,00
1800	72	25.314.1800.21	1800X85,8 SDR21 ISO S-10	1800	85,8	225,0	50,0	1860	2040	125	190,00
2000	78	25.314.2000.21	2000X95,3 SDR21 ISO S-10	2000	95,3	240,0	50,0	2070	2195	140	222,00
2250	90	25.314.2250.21	2250X107,2 SDR21 ISO S-10	2250	107,2	260,0	50,0	2350	2520	160	331,00
2300	91	25.314.2300.21	2300X109,6 SDR21 ISO S-10	2300	109,6	250,0	60,0	2370	2520	160	445,00
2500	102	25.314.2500.21	2500X119,1 SDR21 ISO S-10	2500	119,1	285,0	60,0	2550	2830	175	460,00
2720	108	25.314.2720.21	2720X129,6 SDR21 ISO S-10	2720	129,6	330,0	60,0	2800	2970	190	548,00
2830	114	25.314.2830.21	2830X134,8 SDR21 ISO S-10	2830	134,8	340,0	60,0	2880	3130	200	647,00
3000	120	25.314.3000.21	3000X142,9 SDR21 ISO S-10	3000	142,9	350,0	60,0	3080	3270	210	710,00
800	32	25.314.0800.17	800X47,7 SDR17 ISO S-8	800	47,4	140,0	30,0	840	930	65	22,00
900	36	25.314.0900.17	900X53,3 SDR17 ISO S-8	900	53,3	150,0	30,0	944	1040	70	30,00
1000	40	25.314.1000.17	1000X59,3 SDR17 ISO S-8	1000	59,3	160,0	35,0	1047	1150	75	39,00
1200	48	25.314.1200.17	1200X71,1 SDR17 ISO S-8	1200	71,1	185,0	35,0	1245	1375	90	77,00
1400	54	25.314.1400.17	1400X83,0 SDR17 ISO S-8	1400	83,0	200,0	45,0	1450	1540	100	85,00
1600	66	25.314.1600.17	1600X94,8 SDR17 ISO S-8	1600	94,8	210,0	45,0	1655	1875	110	150,00
1800	72	25.314.1800.17	1800X106,6 SDR17 ISO S-8	1800	106,6	225,0	50,0	1860	2040	125	212,00
2000	78	25.314.2000.17	2000X118,5 SDR17 ISO S-8	2000	118,5	240,0	50,0	2070	2195	140	230,00
2250	90	25.314.2250.17	2250X133,3 SDR17 ISO S-8	2250	133,3	260,0	50,0	2350	2520	160	384,00
2500	102	25.314.2500.17	2500X148,1 SDR17 ISO S-8	2500	148,1	285,0	60,0	2550	2830	175	426,00
800	32	25.314.0800.11	800X72,6 SDR11 ISO S-8	800	72,6	150,0	40,0	840	930	70	34,50
900	36	25.314.0900.11	900X81,7 SDR11 ISO S-8	900	81,7	160,0	35,0	944	1040	75	46,00
1000	40	25.314.1000.11	1000X90,8 SDR11 ISO S-8	1000	90,8	170,0	40,0	1047	1150	80	53,00
1200	48	25.314.1200.11	1200X108,9 SDR11 ISO S-8	1200	108,9	195,0	40,0	1245	1375	95	79,00
1400	54	25.314.1400.11	1400X127,0 SDR11 ISO S-8	1400	127,0	205,0	50,0	1450	1540	105	118,00
1600	66	25.314.1600.11	1600X142,2 SDR11 ISO S-8	1600	142,2	215,0	50,0	1655	1875	115	147,00

Verlängerungen auf Anfrage möglich / Elongations available on request.

für ANSI Flanschverbindung gem. AWWA C207 – 07, Class D (175 – 150 psi)  
for ANSI flange connection acc. AWWA C207 – 07, class D (175 – 150 psi)

**Reduktion konzentrisch**    **Reduction concentric**  
kurze Schenkel                    short spigot  
mechanisch gefertigt            machined  
Stumpfschweißung                butt welding  
PE 100 schwarz                    PE 100 black

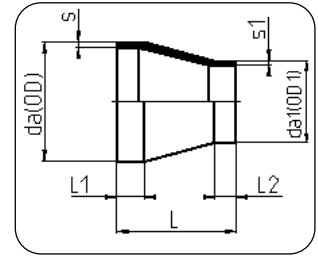
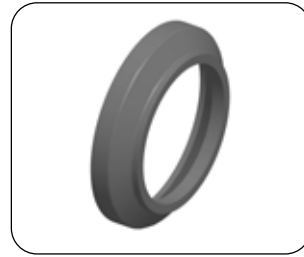

**Code 317**

Dimension	Code	Detail	da/OD [mm]	da1/OD1 [mm]	s [mm]	L [mm]	L1 [mm]	L2 [mm]	s1 [mm]	Gewicht/Weight [kg/m]
800/560	25.317.8056.41	800/560 SDR41 ISO S-20	800	560	19,6	200,0	79,0	40,0	13,7	16,20
800/630	25.317.8063.41	800/630 SDR41 ISO S-20	800	630	19,6	180,0	79,0	40,0	15,4	12,90
800/710	25.317.8071.41	800/710 SDR41 ISO S-20	800	710	19,6	150,0	72,0	40,0	17,4	9,20
900/630	25.317.9063.41	900/630 SDR41 ISO S-20	900	630	22,0	220,0	91,0	40,0	15,4	23,20
900/710	25.317.9071.41	900/710 SDR41 ISO S-20	900	710	22,0	190,0	84,0	40,0	17,4	18,00
900/800	25.317.9080.41	900/800 SDR41 ISO S-20	900	800	22,0	160,0	80,0	40,0	19,6	12,40
1000/710	25.317.1071.41	1000/710 SDR41 ISO S-20	1000	710	24,5	230,0	95,0	40,0	17,4	30,60
1000/800	25.317.1080.41	1000/800 SDR41 ISO S-20	1000	800	24,5	190,0	81,0	40,0	19,6	22,00
1000/900	25.317.1090.41	1000/900 SDR41 ISO S-20	1000	900	24,5	150,0	70,0	40,0	22,0	14,20
1200/900	25.317.1290.41	1200/900 SDR41 ISO S-20	1200	900	29,4	250,0	112,0	40,0	22,0	46,10
1200/1000	25.317.1210.41	1200/1000 SDR41 ISO S-20	1200	1000	29,4	200,0	91,0	40,0	24,5	31,70
1400/1000	25.317.1410.41	1400/1000 SDR41 ISO S-20	1400	1000	34,3	300,0	133,0	40,0	24,5	80,60
1400/1200	25.317.1412.41	1400/1200 SDR41 ISO S-20	1400	1200	34,3	210,0	101,0	40,0	29,4	46,20
1600/1200	25.317.1612.41	1600/1200 SDR41 ISO S-20	1600	1200	39,2	300,0	133,0	40,0	29,4	103,60
1600/1400	25.317.1614.41	1600/1400 SDR41 ISO S-20	1600	1400	39,2	220,0	111,0	40,0	34,3	61,70
1800/1400	25.317.1814.41	1800/1400 SDR41 ISO S-20	1800	1400	44,0	310,0	143,0	40,0	34,3	131,70
1800/1600	25.317.1816.41	1800/1600 SDR41 ISO S-20	1800	1600	44,0	220,0	111,0	40,0	39,2	77,50
2000/1600	25.317.2016.41	2000/1600 SDR41 ISO S-20	2000	1600	48,9	320,0	153,0	40,0	39,2	164,00
2000/1800	25.317.2018.41	2000/1800 SDR41 ISO S-20	2000	1800	48,9	230,0	121,0	40,0	44,0	98,00
2250/1800	25.317.2218.41	2250/1800 SDR41 ISO S-20	2250	1800	55,0	350,0	169,0	40,0	44,0	230,60
2250/2000	25.317.2220.41	2250/2000 SDR41 ISO S-20	2250	2000	55,0	260,0	136,0	40,0	48,9	146,00
2300/2000	25.317.2320.41	2300/2000 SDR41 ISO S-20	2300	2000	56,3	380,0	184	40	49,9	270,00
2300/2250	25.317.2322.41	2300/2250 SDR41 ISO S-20	2300	2250	56,3	260,0	136	40	55,0	150,00
2500/2000	25.317.2520.41	2500/2250 SDR41 ISO S-20	2500	2000	61,2	380,0	184,0	40,0	48,9	313,00
2500/2250	25.317.2520.41	2500/2250 SDR41 ISO S-20	2500	2250	61,2	260,0	136,0	40,0	55,0	175,00
800/560	25.317.8056.33	800/560 SDR33 ISO S-16	800	560	24,5	200,0	79,0	40,0	17,2	17,80
800/630	25.317.8063.33	800/630 SDR33 ISO S-16	800	630	24,5	180,0	79,0	40,0	19,3	14,40
800/710	25.317.8071.33	800/710 SDR33 ISO S-16	800	710	24,5	150,0	72,0	40,0	21,8	10,80
900/630	25.317.9063.33	900/630 SDR33 ISO S-16	900	630	27,6	220,0	91,0	40,0	19,3	25,10
900/710	25.317.9071.33	900/710 SDR33 ISO S-16	900	710	27,6	190,0	84,0	40,0	21,8	20,30
900/800	25.317.9080.33	900/800 SDR33 ISO S-16	900	800	27,6	160,0	80,0	40,0	24,5	14,90
1000/710	24.317.1071.33	1000/710 SDR33 ISO S-16	1000	710	30,6	230,0	95,0	40,0	21,8	33,10
1000/800	24.317.1080.33	1000/800 SDR33 ISO S-16	1000	800	30,6	190,0	81,0	40,0	24,5	25,10
1000/900	25.317.1090.33	1000/900 SDR33 ISO S-16	1000	900	30,6	150,0	70,0	40,0	27,6	17,30
1200/900	25.317.1290.33	1200/900 SDR33 ISO S-16	1200	900	36,7	250,0	112,0	40,0	27,6	51,20
1200/1000	25.317.1210.33	1200/1000 SDR33 ISO S-16	1200	1000	36,7	200,0	91,0	40,0	30,6	31,70
1400/1000	25.317.1410.33	1400/1000 SDR33 ISO S-16	1400	1000	42,9	300,0	133,0	40,0	30,6	87,70
1400/1200	25.317.1412.33	1400/1200 SDR33 ISO S-16	1400	1200	42,9	210,0	101,0	40,0	36,7	52,60

XXL Rohre  
XXL pipes

Formteile  
Fittings

Flansche & Zubehör  
Flanges & Accessories

Schweißtechnik  
Welding Technology

**Reduktion konzentrisch**    **Reduction concentric**  
kurze Schenkel                    short spigot  
mechanisch gefertigt            machined  
Stumpfschweißung                butt welding  
PE 100 schwarz                    PE 100 black

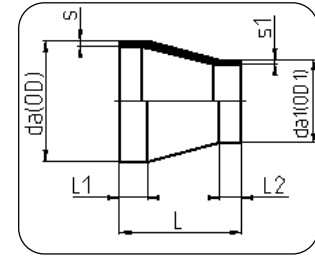
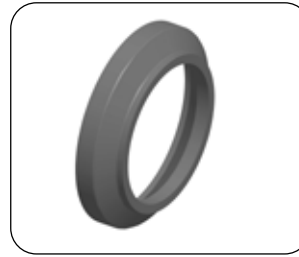

**Code 317**

Dimension	Code	Detail	da/OD [mm]	da1/OD1 [mm]	s [mm]	L [mm]	L1 [mm]	L2 [mm]	s1 [mm]	Gewicht/Weight [kg/m]
1600/1200	25.317.1612.33	1600/1200 SDR33 ISO S-16	1600	1200	49,0	300,0	133,0	40,0	36,7	114,00
1600/1400	25.317.1614.33	1600/1400 SDR33 ISO S-16	1600	1400	49,0	220,0	111,0	40,0	42,9	71,10
1800/1400	25.317.1814.33	1800/1400 SDR33 ISO S-16	1800	1400	55,1	310,0	143,0	40,0	42,9	147,00
1800/1600	25.317.1816.33	1800/1600 SDR33 ISO S-16	1800	1600	55,1	220,0	111,0	40,0	49,0	89,90
2000/1600	25.317.2016.33	2000/1600 SDR33 ISO S-16	2000	1600	61,2	320,0	153,0	40,0	49,0	184,00
2000/1800	25.317.2018.33	2000/1800 SDR33 ISO S-16	2000	1800	61,2	230,0	121,0	40,0	55,1	115,00
2250/1800	25.317.2218.33	2250/1800 SDR33 ISO S-16	2250	1800	68,9	350,0	169,0	40,0	55,1	259,00
2250/2000	25.317.2220.33	2250/2000 SDR33 ISO S-16	2250	2000	68,9	260,0	136,0	40,0	61,2	170,00
2300/2000	25.317.2320.33	2300/2000 SDR33 ISO S-16	2300	2000	70,4	380,0	184,0	40,0	61,2	320,00
2300/2250	25.317.2322.33	2300/2250 SDR33 ISO S-16	2300	2250	70,4	260,0	136,0	40,0	68,9	180,00
2500/2000	25.317.2520.33	2500/2000 SDR33 ISO S-16	2500	2000	76,5	380,0	184,0	40,0	61,2	351,00
2500/2250	25.317.2520.33	2500/2250 SDR33 ISO S-16	2500	2250	76,5	260,0	136,0	40,0	68,9	209,00
800/560	25.317.8056.26	800/560 SDR26 ISO S-12,5	800	560	30,6	200,0	89,0	40,0	21,4	21,40
800/630	25.317.8063.26	800/630 SDR26 ISO S-12,5	800	630	30,6	180,0	79,0	40,0	24,1	17,20
800/710	25.317.8071.26	800/710 SDR26 ISO S-12,5	800	710	30,6	150,0	72,0	40,0	27,2	12,90
900/630	25.317.9063.26	900/630 SDR26 ISO S-12,5	900	630	34,4	220,0	91,0	40,0	24,1	29,40
900/710	25.317.9071.26	900/710 SDR26 ISO S-12,5	900	710	34,4	190,0	84,0	40,0	27,2	23,50
900/800	25.317.9080.26	900/800 SDR26 ISO S-12,5	900	800	34,4	160,0	80,0	40,0	30,6	17,80
1000/710	25.317.1071.26	1000/710 SDR26 ISO S-12,5	1000	710	38,2	240,0	105,0	40,0	27,2	39,20
1000/800	25.317.1080.26	1000/800 SDR26 ISO S-12,5	1000	800	38,2	200,0	91,0	40,0	30,6	31,00
1000/900	25.317.1090.26	1000/900 SDR26 ISO S-12,5	1000	900	38,2	160,0	80,0	40,0	34,4	22,00
1200/900	25.317.1290.26	1200/900 SDR26 ISO S-12,5	1200	900	45,9	250,0	112,0	40,0	34,4	59,70
1200/1000	25.317.1210.26	1200/1000 SDR26 ISO S-12,5	1200	1000	45,9	210,0	101,0	40,0	38,2	46,30
1400/1000	25.317.1410.26	1400/1000 SDR26 ISO S-12,5	1400	1000	53,5	300,0	133,0	40,0	38,2	101,00
1400/1200	25.317.1412.26	1400/1200 SDR26 ISO S-12,5	1400	1200	53,5	210,0	101,0	40,0	45,9	63,40
1600/1200	25.317.1612.26	1600/1200 SDR26 ISO S-12,5	1600	1200	61,2	310,0	143,0	40,0	45,9	136,00
1600/1400	25.317.1614.26	1600/1400 SDR26 ISO S-12,5	1600	1400	61,2	230,0	121,0	40,0	53,5	88,90
1800/1400	25.317.1814.26	1800/1400 SDR26 ISO S-12,5	1800	1400	68,8	310,0	153,0	40,0	53,5	175,00
1800/1600	25.317.1816.26	1800/1600 SDR26 ISO S-12,5	1800	1600	68,8	230,0	121,0	40,0	61,2	112,00
2000/1600	25.317.2016.26	2000/1600 SDR26 ISO S-12,5	2000	1600	76,4	330,0	163,0	40,0	61,2	221,00
2000/1800	25.317.2018.26	2000/1800 SDR26 ISO S-12,5	2000	1800	76,4	240,0	131,0	40,0	68,8	140,00
2250/1800	25.317.2218.26	2250/1800 SDR26 ISO S-12,5	2250	1800	86,0	350,0	169,0	40,0	68,8	294,00
2250/2000	25.317.2220.26	2250/2000 SDR26 ISO S-12,5	2250	2000	86,0	270,0	146,0	40,0	76,4	204,00
2300/2000	25.317.2320.26	2300/2000 SDR26 ISO S-12,5	2300	2000	87,9	380,0	184,0	40,0	76,4	370,00
2300/2250	25.317.2322.26	2300/2250 SDR26 ISO S-12,5	2300	2250	87,9	270,0	146,0	40,0	86,0	230,00
2500/2000	25.317.2520.26	2500/2000 SDR26 ISO S-12,5	2500	2000	95,5	380,0	184,0	40,0	76,4	395,00
2500/2250	25.317.2520.26	2500/2250 SDR26 ISO S-12,5	2500	2250	95,5	270,0	146,0	40,0	86,0	250,00

XXL Rohre  
XXL pipes

Formteile  
Fittings

Flansche & Zubehör  
Flanges & Accessories

Schweißtechnik  
Welding Technology

**Reduktion konzentrisch**    **Reduction concentric**  
kurze Schenkel                    short spigot  
mechanisch gefertigt            machined  
Stumpfschweißung                butt welding  
PE 100 schwarz                    PE 100 black

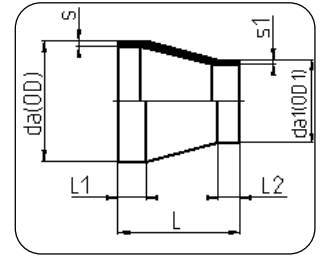

**Code 317**

Dimension	Code	Detail	da/OD [mm]	da1/OD1 [mm]	s [mm]	L [mm]	L1 [mm]	L2 [mm]	s1 [mm]	Gewicht/Weight [kg/m]
800/560	25.317.8056.21	800/560 SDR21 ISO S-10	800	560	38,1	210,0	89,0	40,0	26,7	24,60
800/630	25.317.8063.21	800/630 SDR21 ISO S-10	800	630	38,1	180,0	79,0	40,0	30,0	20,10
800/710	25.317.8071.21	800/710 SDR21 ISO S-10	800	710	38,1	150,0	72,0	40,0	33,9	15,50
900/630	25.317.9063.21	900/630 SDR21 ISO S-10	900	630	42,9	230,0	101,0	40,0	30,0	34,30
900/710	25.317.9071.21	900/710 SDR21 ISO S-10	900	710	42,9	200,0	94,0	40,0	33,9	28,60
900/800	25.317.9080.21	900/800 SDR21 ISO S-10	900	800	42,9	160,0	80,0	40,0	38,1	21,40
1000/710	25.317.1071.21	1000/710 SDR21 ISO S-10	1000	710	47,7	240,0	105,0	40,0	33,9	45,00
1000/800	25.317.1080.21	1000/800 SDR21 ISO S-10	1000	800	47,7	210,0	101,0	40,0	38,1	37,30
1000/900	25.317.1090.21	1000/900 SDR21 ISO S-10	1000	900	47,7	170,0	90,0	40,0	42,9	27,80
1200/900	25.317.1290.21	1200/900 SDR21 ISO S-10	1200	900	57,2	260,0	122,0	40,0	42,9	69,80
1200/1000	25.317.1210.21	1200/1000 SDR21 ISO S-10	1200	1000	57,2	210,0	101,0	40,0	47,7	54,10
1400/1000	25.317.1410.21	1400/1000 SDR21 ISO S-10	1400	1000	66,7	310,0	143,0	40,0	47,7	118,00
1400/1200	25.317.1412.21	1400/1200 SDR21 ISO S-10	1400	1200	66,7	220,0	111,0	40,0	57,2	76,50
1600/1200	25.317.1612.21	1600/1200 SDR21 ISO S-10	1600	1200	76,2	320,0	153,0	40,0	57,2	157,00
1600/1400	25.317.1614.21	1600/1400 SDR21 ISO S-10	1600	1400	76,2	230,0	121,0	40,0	66,7	103,00
1800/1400	25.317.1814.21	1800/1400 SDR21 ISO S-10	1800	1400	85,8	330,0	163,0	40,0	66,7	205,00
1800/1600	25.317.1816.21	1800/1600 SDR21 ISO S-10	1800	1600	85,8	240,0	131,0	40,0	76,2	136,00
2000/1600	25.317.2016.21	2000/1600 SDR21 ISO S-10	2000	1600	95,3	340,0	173,0	40,0	76,2	261,00
2000/1800	25.317.2018.21	2000/1800 SDR21 ISO S-10	2000	1800	95,3	250,0	141,0	40,0	85,8	174,00
2250/1800	25.317.2218.21	2250/1800 SDR21 ISO S-10	2250	1800	107,2	360,0	179,0	40,0	85,8	351,00
2250/2000	25.317.2220.21	2250/2000 SDR21 ISO S-10	2250	2000	107,2	280,0	156,0	40,0	95,3	251,00
800/560	25.317.8056.17	800/560 SDR17 ISO S-8	800	560	47,4	220,0	99,0	40,0	33,2	29,40
800/630	25.317.8063.17	800/630 SDR17 ISO S-8	800	630	47,4	190,0	89,0	40,0	37,4	24,90
800/710	25.317.8071.17	800/710 SDR17 ISO S-8	800	710	47,4	160,0	82,0	40,0	42,1	19,60
900/630	25.317.9063.17	900/630 SDR17 ISO S-8	900	630	53,3	240,0	111,0	40,0	37,4	41,00
900/710	25.317.9071.17	900/710 SDR17 ISO S-8	900	710	53,3	200,0	94,0	40,0	42,1	33,40
900/800	25.317.9080.17	900/800 SDR17 ISO S-8	900	800	53,3	170,0	90,0	40,0	47,4	26,80
1000/710	25.317.1071.17	1000/710 SDR17 ISO S-8	1000	710	59,3	250,0	115,0	40,0	42,1	53,00
1000/800	25.317.1080.17	1000/800 SDR17 ISO S-8	1000	800	59,3	210,0	101,0	40,0	47,4	43,80
1000/900	25.317.1090.17	1000/900 SDR17 ISO S-8	1000	900	59,3	170,0	90,0	40,0	53,3	33,20
1200/900	25.317.1290.17	1200/900 SDR17 ISO S-8	1200	900	71,1	260,0	122,0	40,0	53,3	80,70
1200/1000	25.317.1210.17	1200/1000 SDR17 ISO S-8	1200	1000	71,1	220,0	111,0	40,0	59,3	65,80
1400/1000	25.317.1410.17	1400/1000 SDR17 ISO S-8	1400	1000	83,0	310,0	143,0	40,0	59,3	134,00
1400/1200	25.317.1412.17	1400/1200 SDR17 ISO S-8	1400	1200	83,0	230,0	121,0	40,0	71,1	93,60

XXL Rohre  
XXL pipes

Formteile  
Fittings

Flansche & Zubehör  
Flanges & Accessories

Schweißtechnik  
Welding Technology

**Reduktion konzentrisch**    **Reduction concentric**  
kurze Schenkel                    short spigot  
mechanisch gefertigt            machined  
Stumpfschweißung                butt welding  
PE 100 schwarz                    PE 100 black

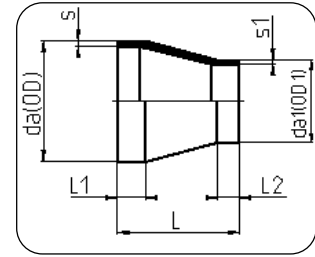
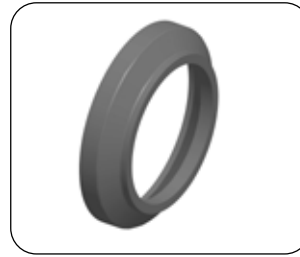

**Code 317**

Dimension	Code	Detail	da/OD [mm]	da1/OD1 [mm]	s [mm]	L [mm]	L1 [mm]	L2 [mm]	s1 [mm]	Gewicht/Weight [kg/m]
1600/1200	25.317.1612.17	1600/1200 SDR17 ISO S-8	1600	1200	94,8	330,0	163,0	40,0	71,1	188,00
1600/1400	25.317.1614.17	1600/1400 SDR17 ISO S-8	1600	1400	94,8	250,0	141,0	40,0	83,0	133,00
1800/1400	25.317.1814.17	1800/1400 SDR17 ISO S-8	1800	1400	106,6	340,0	173,0	40,0	83,0	245,00
1800/1600	25.317.1816.17	1800/1600 SDR17 ISO S-8	1800	1600	106,6	250,0	141,0	40,0	94,8	167,00
2000/1600	25.317.2016.17	2000/1600 SDR17 ISO S-8	2000	1600	118,5	340,0	173,0	40,0	94,8	301,00
2000/1800	25.317.2018.17	2000/1800 SDR17 ISO S-8	2000	1800	118,5	260,0	151,0	40,0	106,6	213,00
800/630	25.317.8063.11	800/630 SDR11 ISO S-5	800	630	72,6	200,0	99,0	40,0	57,2	35,20
800/710	25.317.8071.11	800/710 SDR11 ISO S-5	800	710	72,6	170,0	92,0	40,0	64,5	29,30
900/710	25.317.9071.11	900/710 SDR11 ISO S-5	900	710	81,7	210,0	104,0	40,0	64,5	47,30
900/800	25.317.9080.11	900/800 SDR11 ISO S-5	900	800	81,7	180,0	100,0	40,0	72,6	39,80
1000/710	25.317.1071.11	1000/710 SDR11 ISO S-5	1000	710	90,8	260,0	125,0	40,0	64,5	72,70
1000/800	25.317.1080.11	1000/800 SDR11 ISO S-5	1000	800	90,8	230,0	121,0	40,0	72,6	64,50
1000/900	25.317.1090.11	1000/900 SDR11 ISO S-5	1000	900	90,8	190,0	110,0	40,0	81,7	52,00

Verlängerungen auf Anfrage möglich / Elongations available on request.  
Größere Dimensionen auf Anfrage / Larger dimensions on request.

**Bogen 30°**

2 Segmente  
Abminderungsfaktor 0,8  
Stumpfschweissung  
PE 100 schwarz

**Bend 30°**

2 segments  
reduce pressure rating 0,8  
butt welding  
PE 100 black

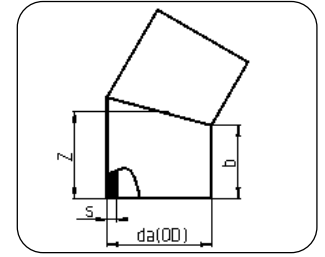
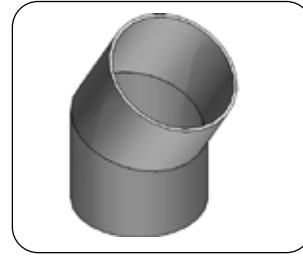

**Code 329**

Dimension	Code	Detail	da/OD [mm]	s [mm]	b [mm]	z [mm]	Gewicht/Weight [kg/m]
800	25.329.0800.41	800X19,6 SDR41 ISO S-20	800	19,6	400	507	49,30
900	25.329.0900.41	900X22,0 SDR41 ISO S-20	900	22,0	400	521	63,90
1000	25.329.1000.41	1000X24,5 SDR41 ISO S-20	1000	24,5	500	634	96,30
1200	25.329.1200.41	1200X29,4 SDR41 ISO S-20	1200	29,4	500	661	144,50
1400	25.329.1400.41	1400X34,3 SDR41 ISO S-20	1400	34,3	500	688	204,50
1600	25.329.1600.41	1600X39,2 SDR41 ISO S-20	1600	39,2	500	715	277,40
1800	25.329.1800.41	1800X44,0 SDR41 ISO S-20	1800	44,0	500	741	362,90
2000	25.329.2000.41	2000X48,9 SDR41 ISO S-20	2000	48,9	500	768	464,40
2250	25.329.2250.41	2250X55,0 SDR41 ISO S-20	2250	55,0	500	802	613,10
2300	25.329.2300.41	2300X56,3 SDR41 ISO S-20	2300	56,3	500	818	685,00
2500	25.329.2500.41	2500X61,2 SDR41 ISO S-20	2500	61,2	500	835	790,00
2720	25.329.2720.41	2720X66,5 SDR41 ISO S-20	2720	66,5	700	1065	1.190,00
2830	25.329.2830.41	2830X69,2 SDR41 ISO S-20	2830	69,2	700	1079	1.306,00
3000	25.329.3000.41	3000X73,4 SDR41 ISO S-20	3000	73,4	700	1102	1.498,70
3260	25.329.3260.41	3260X79,7 SDR41 ISO S-20	3260	79,7	700	1136	1.813,10
3500	25.329.3500.41	3500X85,6 SDR41 ISO S-20	3500	85,6	700	1169	2.298,00
800	25.329.0800.33	800X24,5 SDR33 ISO S-16	800	24,5	400	507	61,20
900	25.329.0900.33	900X27,6 SDR33 ISO S-16	900	27,6	400	521	79,60
1000	25.329.1000.33	1000X30,6 SDR33 ISO S-16	1000	30,6	500	634	119,40
1200	25.329.1200.33	1200X36,7 SDR33 ISO S-16	1200	36,7	500	661	179,00
1400	25.329.1400.33	1400X42,9 SDR33 ISO S-16	1400	42,9	500	688	253,70
1600	25.329.1600.33	1600X49,0 SDR33 ISO S-16	1600	49,0	500	715	344,00
1800	25.329.1800.33	1800X55,1 SDR33 ISO S-16	1800	55,1	500	741	451,60
2000	25.329.2000.33	2000X61,2 SDR33 ISO S-16	2000	61,2	500	768	577,40
2250	25.329.2250.33	2250X68,9 SDR33 ISO S-16	2250	68,9	500	802	762,70
2300	25.329.2300.33	2300X70,4 SDR33 ISO S-16	2300	70,4	500	818	835,00
2500	25.329.2500.33	2500X76,5 SDR33 ISO S-16	2500	76,5	500	835	980,40
2720	25.329.2720.33	2720X83,2 SDR33 ISO S-16	2720	83,2	700	1065	1.479,00
2830	25.329.2830.33	2830X86,6 SDR33 ISO S-16	2830	86,6	700	1079	1.623,00
3000	25.329.3000.33	3000X91,8 SDR33 ISO S-16	3000	91,8	700	1102	1.862,40
3260	25.329.3260.33	3260X99,7 SDR33 ISO S-16	3260	99,7	700	1136	2.251,40
3500	25.329.3500.33	3500X107,1 SDR33 ISO S-16	3500	107,1	700	1169	2.534,00
800	25.329.0800.26	800X30,6 SDR26 ISO S-12,5	800	30,6	400	507	77,70
900	25.329.0900.26	900X34,4 SDR26 ISO S-12,5	900	34,4	400	521	98,30
1000	25.329.1000.26	1000X38,2 SDR26 ISO S-12,5	1000	38,2	500	634	147,70
1200	25.329.1200.26	1200X45,9 SDR26 ISO S-12,5	1200	45,9	500	661	221,80
1400	25.329.1400.26	1400X53,5 SDR26 ISO S-12,5	1400	53,5	500	688	313,70
1600	25.329.1600.26	1600X61,2 SDR26 ISO S-12,5	1600	61,2	500	715	426,20
1800	25.329.1800.26	1800X68,8 SDR26 ISO S-12,5	1800	68,8	500	741	558,70
2000	25.329.2000.26	2000X76,4 SDR26 ISO S-12,5	2000	76,4	500	768	714,50



**Bogen 30°**

2 Segmente  
Abminderungsfaktor 0,8  
Stumpfschweissung  
PE 100 schwarz

**Bend 30°**

2 segments  
reduce pressure rating 0,8  
butt welding  
PE 100 black

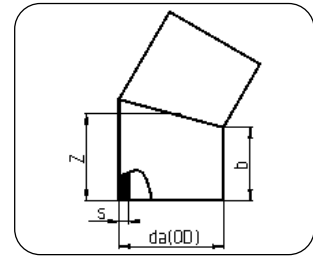
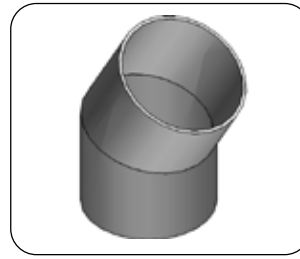

**Code 329**

Dimension	Code	Detail	da/OD [mm]	s [mm]	b [mm]	z [mm]	Gewicht/Weight [kg/m]
2250	25.329.2250.26	2250X86,0 SDR26 ISO S-12,5	2250	86,0	500	802	943,80
2300	25.329.2300.26	2300X87,9 SDR 26 ISO S-12,5	2300	87,9	500	818	1.150,00
2500	25.329.2500.26	2500X95,5 SDR26 ISO S-12,5	2500	95,5	500	835	1.213,40
2720	25.329.2720.26	2720X103,9 SDR26 ISO S-12,5	2720	103,9	700	1065	1.830,60
2830	25.329.2830.26	2830X108,2 SDR26 ISO S-12,5	2830	108,2	700	1079	2.010,00
3000	25.329.3000.26	3000X114,6 SDR26 ISO S-12,5	3000	114,6	700	1102	2.305,50
3260	25.329.3260.26	3260X124,6 SDR26 ISO S-12,5	3260	124,6	700	1136	2.789,20
3500	25.329.3500.26	3500X133,7 SDR26 ISO S-12,5	3500	133,7	700	1169	3.140,00
800	25.329.0800.21	800X38,1 SDR21 ISO S-10	800	38,1	400	507	93,30
900	25.329.0900.21	900X42,9 SDR21 ISO S-10	900	42,9	400	521	121,20
1000	25.329.1000.21	1000X47,7 SDR21 ISO S-10	1000	47,7	500	634	182,30
1200	25.329.1200.21	1200X57,2 SDR21 ISO S-10	1200	57,2	500	661	273,60
1400	25.329.1400.21	1400X66,7 SDR21 ISO S-10	1400	66,7	500	688	386,90
1600	25.329.1600.21	1600X76,2 SDR21 ISO S-10	1600	76,2	500	715	525,00
1800	25.329.1800.21	1800X85,8 SDR21 ISO S-10	1800	85,8	500	741	689,30
2000	25.329.2000.21	2000X95,3 SDR21 ISO S-10	2000	95,3	500	768	881,80
2250	25.329.2250.21	2250X107,2 SDR21 ISO S-10	2250	107,2	500	802	1.164,50
2300	25.329.2300.21	2300X109,6 SDR21 ISO S-10	2300	109,6	500	818	1.270,00
2500	25.329.2500.21	2500X119,1 SDR21 ISO S-10	2500	119,1	500	835	1.497,50
2720	25.329.2720.21	2720X129,6 SDR21 ISO S-10	2720	129,6	700	1065	2.259,60
2830	25.329.2830.21	2830X134,8 SDR21 ISO S-10	2830	134,8	700	1079	2.477,00
3000	25.329.3000.21	3000X142,9 SDR21 ISO S-10	3000	142,9	700	1102	2.844,30
800	25.329.0800.17	800X47,4 SDR17 ISO S-8	800	47,4	400	507	114,50
900	25.329.0900.17	900X53,3 SDR17 ISO S-8	900	53,3	400	521	148,60
1000	25.329.1000.17	1000X59,3 SDR17 ISO S-8	1000	59,3	500	634	223,70
1200	25.329.1200.17	1200X71,1 SDR17 ISO S-8	1200	71,1	500	661	335,60
1400	25.329.1400.17	1400X83,0 SDR17 ISO S-8	1400	83,0	500	688	475,00
1600	25.329.1600.17	1600X94,8 SDR17 ISO S-8	1600	94,8	500	715	644,40
1800	25.329.1800.17	1800X106,6 SDR17 ISO S-8	1800	106,6	500	741	845,40
2000	25.329.2000.17	2000X118,4 SDR17 ISO S-8	2000	118,4	500	768	1.082,10
2250	25.329.2250.17	2250X133,3 SDR17 ISO S-8	2250	133,3	500	802	1.429,10
2300	25.329.2300.17	2300X136,2 SDR17 ISO S-8	2300	136,2	500	818	1.630,00
2500	25.329.2500.17	2500X148,1 SDR17 ISO S-8	2500	148,1	500	835	1.837,80
800	25.329.0800.11	800X72,6 SDR11 ISO S-5	800	72,6	400	507	169,00
900	25.329.0900.11	900X81,7 SDR11 ISO S-5	900	81,7	400	521	219,60
1000	25.329.1000.11	1000X90,8 SDR11 ISO S-5	1000	90,8	500	634	330,20
1200	25.329.1200.11	1200X108,9 SDR11 ISO S-5	1200	108,9	500	661	495,40
1400	25.329.1400.11	1400X127,0 SDR11 ISO S-5	1400	127,0	500	688	700,90
1600	25.329.1600.11	1600X145,2 SDR11 ISO S-5	1600	145,2	500	715	951,90



**Bogen 30°**  
3 Segmente  
druckklassengerecht  
Stumpfschweissung  
PE 100 schwarz

**Bend 30°**  
3 segments  
full pressure rated  
butt welding  
PE 100 black

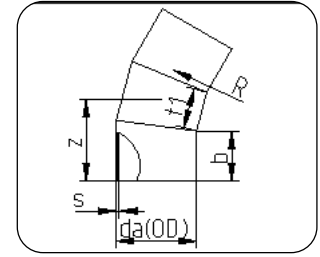
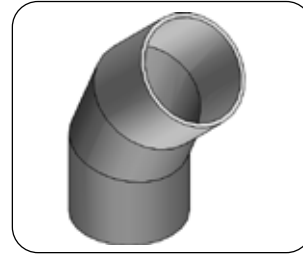

**Code 321**

Dimension	Code	Detail	da/OD [mm]	s [mm]	r [mm]	b [mm]	t1 [mm]	z [mm]	Gewicht/Weight [kg/m]
800	25.321.0800.41	800X19,6 SDR41 ISO S-20	800	19,6	1919	500	400	814	78,30
900	25.321.0900.41	900X22,0 SDR41 ISO S-20	900	22,0	2197	500	460	859	104,00
1000	25.321.1000.41	1000X24,5 SDR41 ISO S-20	1000	24,5	2399	500	500	893	134,00
1200	25.321.1200.41	1200X29,4 SDR41 ISO S-20	1200	29,4	2879	500	600	971	209,40
1400	25.321.1400.41	1400X34,3 SDR41 ISO S-20	1400	34,3	2219	500	400	895	262,90
1600	25.321.1600.41	1600X39,2 SDR41 ISO S-20	1600	39,2	2319	500	400	921	353,70
1800	25.321.1800.41	1800X44,0 SDR41 ISO S-20	1800	44,0	2419	500	400	948	458,90
2000	25.321.2000.41	2000X48,9 SDR41 ISO S-20	2000	48,9	3089	500	550	1053	627,70
2250	25.321.2250.41	2250X55,0 SDR41 ISO S-20	2250	55,0	3404	500	600	1112	838,40
2300	25.321.2300.41	2300X56,3 SDR41 ISO S-20	2300	56,3	3484	500	600	1134	954,00
2500	25.321.2500.41	2500X61,2 SDR41 ISO S-20	2500	61,2	3529	500	600	1146	1.068,20
2720	25.321.2720.41	2720X66,5 SDR41 ISO S-20	2720	66,5	4019	700	700	1427	1.574,30
2830	25.321.2830.41	2830X69,2 SDR41 ISO S-20	2830	69,2	4074	700	700	1441	1.722,00
3000	25.321.3000.41	3000X73,4 SDR41 ISO S-20	3000	73,4	4159	700	700	1464	1.966,70
3260	25.321.3260.41	3260X79,7 SDR41 ISO S-20	3260	79,7	4284	700	700	1498	2.250,00
800	25.321.0800.33	800X24,5 SDR33 ISO S-16	800	24,5	1919	500	400	814	97,20
900	25.321.0900.33	900X27,6 SDR33 ISO S-16	900	27,6	2197	500	460	859	129,60
1000	25.321.1000.33	1000X30,6 SDR33 ISO S-16	1000	30,6	2399	500	500	893	166,00
1200	25.321.1200.33	1200X36,7 SDR33 ISO S-16	1200	36,7	2879	500	600	971	259,40
1400	25.321.1400.33	1400X42,9 SDR33 ISO S-16	1400	42,9	2219	500	400	895	326,20
1600	25.321.1600.33	1600X49,0 SDR33 ISO S-16	1600	49,0	2319	500	400	921	438,60
1800	25.321.1800.33	1800X55,1 SDR33 ISO S-16	1800	55,1	2419	500	400	948	571,00
2000	25.321.2000.33	2000X61,2 SDR33 ISO S-16	2000	61,2	3089	500	550	1053	780,50
2250	25.321.2250.33	2250X68,9 SDR33 ISO S-16	2250	68,9	3404	500	600	1112	1.043,00
2300	25.321.2300.33	2300X70,4 SDR33 ISO S-16	2300	70,4	3484	500	600	1134	1.124,00
2500	25.321.2500.33	2500X76,5 SDR33 ISO S-16	2500	76,5	3529	500	600	1146	1.325,60
2720	25.321.2720.33	2720X83,2 SDR33 ISO S-16	2720	83,2	4019	700	700	1427	1.956,30
2830	25.321.2830.33	2830X86,6 SDR33 ISO S-16	2830	86,6	4074	700	700	1441	2.140,00
3000	25.321.3000.33	3000X91,8 SDR33 ISO S-16	3000	91,8	4159	700	700	1464	2.442,10
3260	25.321.3260.33	3260X99,7 SDR33 ISO S-16	3260	99,7	4284	700	700	1498	2.790,00
800	25.321.0800.26	800X30,6 SDR26 ISO S-12,5	800	30,6	1919	500	400	814	120,20
900	25.321.0900.26	900X34,4 SDR26 ISO S-12,5	900	34,4	2197	500	460	859	160,20
1000	25.321.1000.26	1000X38,2 SDR26 ISO S-12,5	1000	38,2	2399	500	500	893	205,50
1200	25.321.1200.26	1200X45,9 SDR26 ISO S-12,5	1200	45,9	2879	500	600	971	321,40
1400	25.321.1400.26	1400X53,5 SDR26 ISO S-12,5	1400	53,5	2219	500	400	895	403,40
1600	25.321.1600.26	1600X61,2 SDR26 ISO S-12,5	1600	61,2	2319	500	400	921	543,40
1800	25.321.1800.26	1800X68,8 SDR26 ISO S-12,5	1800	68,8	2419	500	400	948	706,50
2000	25.321.2000.26	2000X76,4 SDR26 ISO S-12,5	2000	76,4	3089	500	550	1053	965,70

**Bogen 30°**  
3 Segmente  
druckklassengerecht  
Stumpfschweissung  
PE 100 schwarz

**Bend 30°**  
3 segments  
full pressure rated  
butt welding  
PE 100 black

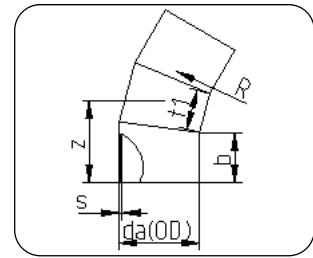
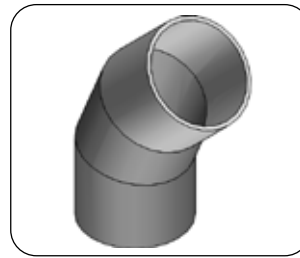

**Code 321**

Dimension	Code	Detail	da/OD [mm]	s [mm]	r [mm]	b [mm]	t1 [mm]	z [mm]	Gewicht/Weight [kg/m]
2250	25.321.2250.26	2250X86,0 SDR26 ISO S-12,5	2250	86,0	3404	500	600	1112	1.290,60
2300	25.321.2300.26	2300X87,9 SDR26 ISO S-12,5	2300	87,9	3484	500	600	1134	1.384,00
2500	25.321.2500.26	2500X95,5 SDR26 ISO S-12,5	2500	95,5	3529	500	600	1146	1.640,60
2720	25.321.2720.26	2720X103,9 SDR26 ISO S-12,5	2720	103,9	4019	700	700	1427	2.421,30
2830	25.321.2830.26	2830X108,2 SDR26 ISO S-12,5	2830	108,2	4074	700	700	1441	2.649,00
3000	25.321.3000.26	3000X114,6 SDR26 ISO S-12,5	3000	114,6	4159	700	700	1464	3.023,10
3260	25.321.3260.26	3260X124,6 SDR26 ISO S-12,5	3260	124,6	4284	700	700	1498	3.460,00
800	25.321.0800.21	800X38,1 SDR21 ISO S-10	800	38,1	1919	500	400	814	148,10
900	25.321.0900.21	900X42,9 SDR21 ISO S-10	900	42,9	2197	500	460	859	197,40
1000	25.321.1000.21	1000X47,7 SDR21 ISO S-10	1000	47,7	2399	500	500	893	253,70
1200	25.321.1200.21	1200X57,2 SDR21 ISO S-10	1200	57,2	2879	500	600	971	396,50
1400	25.321.1400.21	1400X66,7 SDR21 ISO S-10	1400	66,7	2219	500	400	895	497,40
1600	25.321.1600.21	1600X76,2 SDR21 ISO S-10	1600	76,2	2319	500	400	921	669,40
1800	25.321.1800.21	1800X85,8 SDR21 ISO S-10	1800	85,8	2419	500	400	948	871,60
2000	25.321.2000.21	2000X95,3 SDR21 ISO S-10	2000	95,3	3089	500	550	1053	1.191,90
2250	25.321.2250.21	2250X107,2 SDR21 ISO S-10	2250	107,2	3404	500	600	1112	1.592,40
2300	25.321.2300.21	2300X109,6 SDR 21 ISO S-10	2300	109,6	3484	500	600	1134	1.713,00
2500	25.321.2500.21	2500X119,1 SDR21 ISO S-10	2500	119,1	3529	500	600	1146	2.024,80
2720	25.321.2720.21	2720X129,6 SDR21 ISO S-10	2720	129,6	4019	700	700	1427	2.988,80
2830	25.321.2830.21	2830X134,8 SDR21 ISO S-10	2830	134,8	4074	700	700	1441	3.267,00
3000	25.321.3000.21	3000X142,9 SDR21 ISO S-10	3000	142,9	4159	700	700	1464	3.729,60
800	25.321.0800.17	800X47,4 SDR17 ISO S-8	800	47,4	1919	500	400	814	181,70
900	25.321.0900.17	900X53,3 SDR17 ISO S-8	900	53,3	2197	500	460	859	242,20
1000	25.321.1000.17	1000X59,3 SDR17 ISO S-8	1000	59,3	2399	500	500	893	311,30
1200	25.321.1200.17	1200X71,1 SDR17 ISO S-8	1200	71,1	2879	500	600	971	486,40
1400	25.321.1400.17	1400X83,0 SDR17 ISO S-8	1400	83,0	2219	500	400	895	610,70
1600	25.321.1600.17	1600X94,8 SDR17 ISO S-8	1600	94,8	2319	500	400	921	821,60
1800	25.321.1800.17	1800X106,6 SDR17 ISO S-8	1800	106,6	2419	500	400	948	1.069,00
2000	25.321.2000.17	2000X118,4 SDR17 ISO S-8	2000	118,4	3089	500	550	1053	1.462,50
2250	25.321.2250.17	2250X133,3 SDR17 ISO S-8	2250	133,3	3404	500	600	1112	1.954,20
2300	25.321.2300.17	2300X136,2 SDR 17 ISO S-8	2300	136,2	3484	500	600	1134	2.143,00
2500	25.321.2500.17	2500X148,1 SDR17 ISO S-8	2500	148,1	3529	500	600	1146	2.485,00
800	25.321.0800.11	800X72,6 SDR11 ISO S-5	800	72,6	1919	500	400	814	268,30
900	25.321.0900.11	900X81,7 SDR11 ISO S-5	900	81,7	2197	500	460	859	357,70
1000	25.321.1000.11	1000X90,8 SDR11 ISO S-5	1000	90,8	2399	500	500	893	459,30
1200	25.321.1200.11	1200X108,9 SDR11 ISO S-5	1200	108,9	2879	500	600	971	717,90
1400	25.321.1400.11	1400X127,0 SDR11 ISO S-5	1400	127,0	2219	500	400	895	901,30
1600	25.321.1600.11	1600X145,2 SDR11 ISO S-5	1600	145,2	2319	500	400	921	1.213,70

XXL Rohre  
XXL pipes

Formteile  
Fittings

Flansche & Zubehör  
Flanges & Accessories

Schweißtechnik  
Welding Technology

**Bogen 45°**

3 Segmente  
Abminderungsfaktor 0,8  
Stumpfschweissung  
PE 100 schwarz

**Bend 45°**

3 segments  
reduced pressure rating  
0,8  
butt welding  
PE 100 black

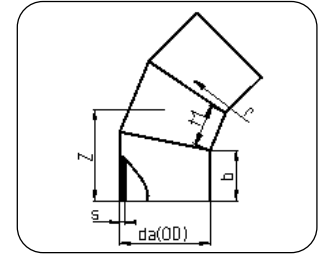
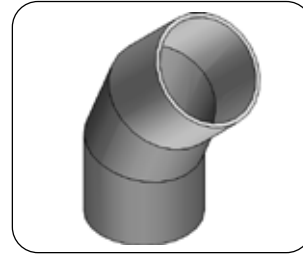

**Code 330**

Dimension	Code	Detail	da/OD [mm]	s [mm]	r [mm]	b [mm]	t1 [mm]	z [mm]	Gewicht/Weight [kg/m]
800	25.330.0800.41	800X19,6 SDR41 ISO S-20	800	19,6	1200	400	318,3	738	69,90
900	25.330.0900.41	900X22,0 SDR41 ISO S-20	900	22,0	1350	400	358	780	93,00
1000	25.330.1000.41	1000X24,5 SDR41 ISO S-20	1000	24,5	1500	500	398	923	136,40
1200	25.330.1200.41	1200X29,4 SDR41 ISO S-20	1200	29,4	1800	500	477,5	1007	213,80
1400	25.330.1400.41	1400X34,3 SDR41 ISO S-20	1400	34,3	1705	500	400	1006	290,90
1600	25.330.1600.41	1600X39,2 SDR41 ISO S-20	1600	39,2	1920	500	446	1073	404,20
1800	25.330.1800.41	1800X44,0 SDR41 ISO S-20	1800	44,0	2160	500	501	1144	542,90
2000	25.330.2000.41	2000X48,9 SDR41 ISO S-20	2000	48,9	2400	500	557	1216	711,40
2250	25.330.2250.41	2250X55,0 SDR41 ISO S-20	2250	55,0	2700	500	627	1305	965,00
2300	25.330.2300.41	2300X56,3 SDR41 ISO S-20	2300	56,3	2734	500	600	1383	954,00
2500	25.330.2500.41	2500X61,2 SDR41 ISO S-20	2500	61,2	2758	500	600	1442	1.321,70
2720	25.330.2720.41	2720X66,5 SDR41 ISO S-20	2720	66,5	3120	700	700	1642	1.611,20
2830	25.330.2830.41	2830X69,2 SDR41 ISO S-20	2830	69,2	3175	700	700	1665	1.951,80
3000	25.330.3000.41	3000X73,4 SDR41 ISO S-20	3000	73,4	3260	700	700	1700	2.037,50
3260	25.330.3260.41	3260X79,7 SDR41 ISO S-20	3260	79,7	3385	700	700	1752	2.580,00
3500	25.330.3500.41	3500X85,6 SDR41 ISO S-20	3500	85,6	4409	700	700	1804	2.298,00
800	25.330.0800.33	800X24,5 SDR33 ISO S-16	800	24,5	1200	400	318,3	738	86,70
900	25.330.0900.33	900X27,6 SDR33 ISO S-16	900	27,6	1350	400	358	780	115,90
1000	25.330.1000.33	1000X30,6 SDR33 ISO S-16	1000	30,6	1500	500	398	923	169,00
1200	25.330.1200.33	1200X36,7 SDR33 ISO S-16	1200	36,7	1800	500	477,5	1007	264,80
1400	25.330.1400.33	1400X42,9 SDR33 ISO S-16	1400	42,9	1705	500	400	1006	360,90
1600	25.330.1600.33	1600X49,0 SDR33 ISO S-16	1600	49,0	1920	500	446	1073	501,20
1800	25.330.1800.33	1800X55,1 SDR33 ISO S-16	1800	55,1	2160	500	501	1144	675,60
2000	25.330.2000.33	2000X61,2 SDR33 ISO S-16	2000	61,2	2400	500	557	1216	884,60
2250	25.330.2250.33	2250X68,9 SDR33 ISO S-16	2250	68,9	2700	500	627	1305	1.200,50
2300	25.330.2300.33	2300X70,4 SDR33 ISO S-16	2300	70,4	2734	500	600	1383	1.124,00
2500	25.330.2500.33	2500X76,5 SDR33 ISO S-16	2500	76,5	2758	500	600	1442	1.640,20
2720	25.330.2720.33	2720X83,2 SDR33 ISO S-16	2720	83,2	3120	700	700	1642	2.002,10
2830	25.330.2830.33	2830X86,6 SDR33 ISO S-16	2830	86,6	3175	700	700	1665	2.426,00
3000	25.330.3000.33	3000X91,8 SDR33 ISO S-16	3000	91,8	3260	700	700	1700	2.530,00
3260	25.330.3260.33	3260X99,7 SDR33 ISO S-16	3260	99,7	3385	700	700	1752	3.205,00
3500	25.330.3500.33	3500X107,10 SDR33 ISO S-16	3500	107,1	4409	700	700	1804	2.534,00
800	25.330.0800.26	800X30,6 SDR26 ISO S-12,5	800	30,6	1200	400	318,3	738	107,20
900	25.330.0900.26	900X34,4 SDR26 ISO S-12,5	900	34,4	1350	400	358	780	143,20
1000	25.330.1000.26	1000X38,2 SDR26 ISO S-12,5	1000	38,2	1500	500	398	923	209,20
1200	25.330.1200.26	1200X45,9 SDR26 ISO S-12,5	1200	45,9	1800	500	477,5	1007	328,20
1400	25.330.1400.26	1400X53,5 SDR26 ISO S-12,5	1400	53,5	1705	500	400	1006	446,30
1600	25.330.1600.26	1600X61,2 SDR26 ISO S-12,5	1600	61,2	1920	500	446	1073	621,00
1800	25.330.1800.26	1800X68,8 SDR26 ISO S-12,5	1800	68,8	2160	500	501	1144	835,80
2000	25.330.2000.26	2000X76,4 SDR26 ISO S-12,5	2000	76,4	2400	500	557	1216	1.094,60

**Bogen 45°**

3 Segmente  
Abminderungsfaktor 0,8  
Stumpfschweissung  
PE 100 schwarz

**Bend 45°**

3 segments  
reduced pressure rating  
0,8  
butt welding  
PE 100 black

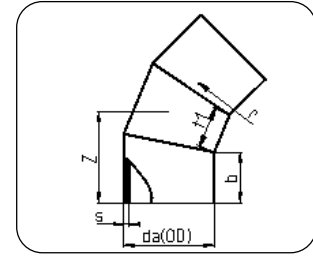
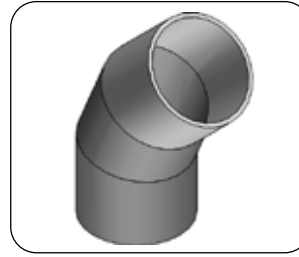

**Code 330**

Dimension	Code	Detail	da/OD [mm]	s [mm]	r [mm]	b [mm]	t1 [mm]	z [mm]	Gewicht/Weight [kg/m]
2250	25.330.2250.26	2250X86,0 SDR26 ISO S-12,5	2250	86,0	2700	500	627	1305	1.485,50
2300	25.330.2300.26	2300X87,9 SDR26 ISO S-12,5	2300	87,9	3463	500	600	1586	1.938,00
2500	25.330.2500.26	2500X95,5 SDR26 ISO S-12,5	2500	95,5	2758	500	600	1442	2.030,10
2720	25.330.2720.26	2720X103,9 SDR26 ISO S-12,5	2720	103,9	3120	700	700	1642	2.478,10
2830	25.330.2830.26	2830X108,2 SDR26 ISO S-12,5	2830	108,2	3175	700	700	1665	3.003,40
3000	25.330.3000.26	3000X114,6 SDR26 ISO S-12,5	3000	114,6	3260	700	700	1700	3.131,90
3260	25.330.3260.26	3260X124,6 SDR26 ISO S-12,5	3260	124,6	3385	700	700	1752	3.973,00
3500	25.330.3500.26	3500X133,7 SDR26 ISO S-12,5	3500	133,7	4409	700	700	1804	4.691,00
800	25.330.0800.21	800X38,1 SDR21 ISO S-10	800	38,1	1200	400	318,3	738	132,10
900	25.330.0900.21	900X42,9 SDR21 ISO S-10	900	42,9	1350	400	358	780	176,50
1000	25.330.1000.21	1000X47,7 SDR21 ISO S-10	1000	47,7	1500	500	398	923	258,30
1200	25.330.1200.21	1200X57,2 SDR21 ISO S-10	1200	57,2	1800	500	477,5	1007	404,80
1400	25.330.1400.21	1400X66,7 SDR21 ISO S-10	1400	66,7	1705	500	400	1006	550,30
1600	25.330.1600.21	1600X76,2 SDR21 ISO S-10	1600	76,2	1920	500	446	1073	764,90
1800	25.330.1800.21	1800X85,8 SDR21 ISO S-10	1800	85,8	2160	500	501	1144	1.031,20
2000	25.330.2000.21	2000X95,3 SDR21 ISO S-10	2000	95,3	2400	500	557	1216	1.350,90
2250	25.330.2250.21	2250X107,2 SDR21 ISO S-10	2250	107,2	2700	500	627	1305	1.832,90
2300	25.330.2300.21	2300X109,6 SDR21 ISO S-10	2300	109,6	2734	500	600	1383	1.713,00
2500	25.330.2500.21	2500X119,1 SDR21 ISO S-10	2500	119,1	2758	500	600	1442	2.505,40
2720	25.330.2720.21	2720X129,6 SDR21 ISO S-10	2720	129,6	3120	700	700	1642	3.058,80
2830	25.330.2830.21	2830X134,8 SDR21 ISO S-10	2830	134,8	3175	700	700	1665	3.703,50
3000	25.330.3000.21	3000X142,9 SDR21 ISO S-10	3000	142,9	3260	700	700	1700	3.863,80
800	25.330.0800.17	800X47,4 SDR17 ISO S-8	800	47,4	1200	400	318,3	738	162,10
900	25.330.0900.17	900X53,3 SDR17 ISO S-8	900	53,3	1350	400	358	780	216,50
1000	25.330.1000.17	1000X59,3 SDR17 ISO S-8	1000	59,3	1500	500	398	923	316,90
1200	25.330.1200.17	1200X71,1 SDR17 ISO S-8	1200	71,1	1800	500	477,5	1007	496,50
1400	25.330.1400.17	1400X83,0 SDR17 ISO S-8	1400	83,0	1705	500	400	1006	675,70
1600	25.330.1600.17	1600X94,8 SDR17 ISO S-8	1600	94,8	1920	500	446	1073	938,80
1800	25.330.1800.17	1800X106,6 SDR17 ISO S-8	1800	106,6	2160	500	501	1144	1.264,60
2000	25.330.2000.17	2000X118,4 SDR17 ISO S-8	2000	118,4	2400	500	557	1216	1.657,60
2250	25.330.2250.17	2250X133,3 SDR17 ISO S-8	2250	133,3	2700	500	627	1305	2.249,30
2300	25.330.2300.17	2300X136,2 SDR17 ISO S-8	2300	136,2	2734	500	600	1383	2.143,00
2500	25.330.2500.17	2500X148,1 SDR17 ISO S-8	2500	148,1	2758	500	600	1442	3.074,80
800	25.330.0800.11	800X72,6 SDR11 ISO S-5	800	72,6	1200	400	318,3	738	239,30
900	25.330.0900.11	900X81,7 SDR11 ISO S-5	900	81,7	1350	400	358	780	319,70
1000	25.330.1000.11	1000X90,8 SDR11 ISO S-5	1000	90,8	1500	500	398	923	467,70
1200	25.330.1200.11	1200X108,9 SDR11 ISO S-5	1200	108,9	1800	500	477,5	1007	732,91
1400	25.330.1400.11	1600X127,0 SDR11 ISO S-5	1400	127,0	1705	500	400	1006	997,10
1600	25.330.1600.11	1600X145,2 SDR11 ISO S-5	1600	145,2	1920	500	446	1073	1.386,90

**Bogen 45°**  
4 Segmente  
Druckklassengerecht  
Stumpfschweissung  
PE 100 schwarz

**Bend 45°**  
4 segments  
full pressure rated  
butt welding  
PE 100 black

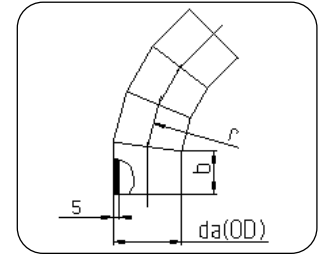
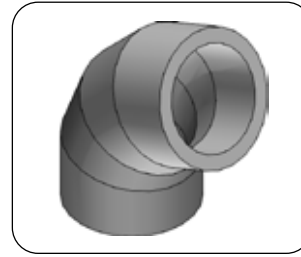

**Code 327**

Dimension	Code	Detail	da/OD [mm]	s [mm]	r [mm]	b [mm]	t1 [mm]	z [mm]	Gewicht/Weight [kg/m]
800	25.327.0800.41	800X19,6 SDR41 ISO S-20	800	19,6	1919	500	400	1041	102,90
900	25.327.0900.41	900X22,0 SDR41 ISO S-20	900	22,0	2197	500	460	1118	139,60
1000	25.327.1000.41	1000X24,5 SDR41 ISO S-20	1000	24,5	2399	500	500	1176	181,90
1200	25.327.1200.41	1200X29,4 SDR41 ISO S-20	1200	29,4	2879	500	600	1311	292,30
1400	25.327.1400.41	1400X34,3 SDR41 ISO S-20	1400	34,3	2219	500	400	1157	349,90
1600	25.327.1600.41	1600X39,2 SDR41 ISO S-20	1600	39,2	2319	500	400	1195	472,20
1800	25.327.1800.41	1800X44,0 SDR41 ISO S-20	1800	44,0	2419	500	400	1234	614,90
2000	25.327.2000.41	2000X48,9 SDR41 ISO S-20	2000	48,9	3089	500	550	1417	873,80
2250	25.327.2250.41	2250X55,0 SDR41 ISO S-20	2250	55,0	3404	500	600	1514	1.076,00
2300	25.327.2300.41	2300X56,3 SDR41 ISO S-20	2300	56,3	3463	500	600	1586	1.137,00
2500	25.327.2500.41	2500X61,2 SDR41 ISO S-20	2500	61,2	3529	500	600	1662	1.554,90
2720	25.327.2720.41	2720X66,5 SDR41 ISO S-20	2720	66,5	4019	700	700	2015	2.165,80
2830	25.327.2830.41	2830X69,2 SDR41 ISO S-20	2830	69,2	4074	700	700	2037	2.370,40
3000	25.327.3000.41	3000X73,4 SDR41 ISO S-20	3000	73,4	4159	700	700	2073	2.711,90
3260	25.327.3260.41	3260X79,7 SDR41 ISO S-20	3260	79,7	4284	700	700	2124	3.110,00
3500	25.327.3500.41	3500X85,6 SDR41 ISO S-20	3500	85,6	4409	700	700	2176	4.155,00
800	25.327.0800.33	800X24,5 SDR33 ISO S-16	800	24,5	1919	500	400	1041	127,70
900	25.327.0900.33	900X27,6 SDR33 ISO S-16	900	27,6	2197	500	460	1118	173,90
1000	25.327.1000.33	1000X30,6 SDR33 ISO S-16	1000	30,6	2399	500	500	1176	225,40
1200	25.327.1200.33	1200X36,7 SDR33 ISO S-16	1200	36,7	2879	500	600	1311	362,00
1400	25.327.1400.33	1400X42,9 SDR33 ISO S-16	1400	42,9	2219	500	400	1157	434,10
1600	25.327.1600.33	1600X49,0 SDR33 ISO S-16	1600	49,0	2319	500	400	1195	585,50
1800	25.327.1800.33	1800X55,1 SDR33 ISO S-16	1800	55,1	2419	500	400	1234	765,10
2000	25.327.2000.33	2000X61,2 SDR33 ISO S-16	2000	61,2	3089	500	550	1417	1.086,50
2250	25.327.2250.33	2250X68,9 SDR33 ISO S-16	2250	68,9	3404	500	600	1514	1.495,00
2300	25.327.2300.33	2300X70,4 SDR33 ISO S-16	2300	70,4	3463	500	600	1586	1.542,00
2500	25.327.2500.33	2500X76,5 SDR33 ISO S-16	2500	76,5	3529	500	600	1662	1.929,70
2720	25.327.2720.33	2720X83,2 SDR33 ISO S-16	2720	83,2	4019	700	700	2015	2.691,30
2830	25.327.2830.33	2830X86,6 SDR33 ISO S-16	2830	86,6	4074	700	700	2037	2.946,40
3000	25.327.3000.33	3000X91,8 SDR33 ISO S-16	3000	91,8	4159	700	700	2073	3.367,40
3260	25.327.3260.33	3260X99,7 SDR33 ISO S-16	3260	99,7	4284	700	700	2124	3.860,00
3500	70.327.3500.33	3500X107,1 SDR33 ISO S-16	3500	107,1	4409	700	700	2176	4.581,00
800	25.327.0800.26	800X30,6 SDR26 ISO S-12,5	800	30,6	1919	500	400	1041	158,00
900	25.327.0900.26	900X34,4 SDR26 ISO S-12,5	900	34,4	2197	500	460	1118	214,80
1000	25.327.1000.26	1000X38,2 SDR26 ISO S-12,5	1000	38,2	2399	500	500	1176	279,00
1200	25.327.1200.26	1200X45,9 SDR26 ISO S-12,5	1200	45,9	2879	500	600	1311	448,60
1400	25.327.1400.26	1400X53,5 SDR26 ISO S-12,5	1400	53,5	2219	500	400	1157	536,80
1600	25.327.1600.26	1600X61,2 SDR26 ISO S-12,5	1600	61,2	2319	500	400	1195	725,40
1800	25.327.1800.26	1800X68,8 SDR26 ISO S-12,5	1800	68,8	2419	500	400	1234	946,60
2000	25.327.2000.26	2000X76,4 SDR26 ISO S-12,5	2000	76,4	3089	500	550	1417	1.344,40

**Bogen 45°**  
4 Segmente  
Druckklassengerecht  
Stumpfschweissung  
PE 100 schwarz

**Bend 45°**  
4 segments  
full pressure rated  
butt welding  
PE 100 black

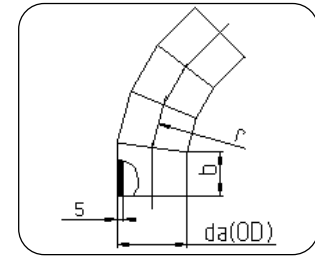
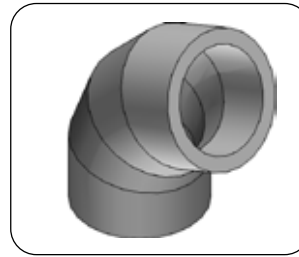

**Code 327**

Dimension	Code	Detail	da/OD [mm]	s [mm]	r [mm]	b [mm]	t1 [mm]	z [mm]	Gewicht/Weight [kg/m]
2250	25.327.2250.26	2250X86,0 SDR26 ISO S-12,5	2250	86,0	3404	500	600	1514	1.850,00
2300	25.327.2300.26	2300X87,9 SDR26 ISO S-12,5	2300	87,9	3463	500	600	1586	1.938,00
2500	25.327.2500.26	2500X95,5 SDR26 ISO S-12,5	2500	95,5	3529	500	600	1662	2.388,30
2720	25.327.2720.26	2720X103,9 SDR26 ISO S-12,5	2720	103,9	4019	700	700	2015	3.331,00
2830	25.327.2830.26	2830X108,2 SDR26 ISO S-12,5	2830	108,2	4074	700	700	2037	3.647,60
3000	25.327.3000.26	3000X114,6 SDR26 ISO S-12,5	3000	114,6	4159	700	700	2073	4.168,50
3260	25.327.3260.26	3260X124,6 SDR26 ISO S-12,5	3260	124,6	4284	700	700	2124	4.785,00
3500	25.327.3500.26	3500X133,7 SDR26 ISO S-12,5	3500	133,7	4409	700	700	2176	5.677,00
800	25.327.0800.21	800X38,1 SDR21 ISO S-10	800	38,1	1919	500	400	1041	164,70
900	25.327.0900.21	900X42,9 SDR21 ISO S-10	900	42,9	2197	500	460	1118	264,80
1000	25.327.1000.21	1000X47,7 SDR21 ISO S-10	1000	47,7	2399	500	500	1176	344,40
1200	25.327.1200.21	1200X57,2 SDR21 ISO S-10	1200	57,2	2879	500	600	1311	553,40
1400	25.327.1400.21	1400X66,7 SDR21 ISO S-10	1400	66,7	2219	500	400	1157	662,00
1600	25.327.1600.21	1600X76,2 SDR21 ISO S-10	1600	76,2	2319	500	400	1195	893,50
1800	25.327.1800.21	1800X85,8 SDR21 ISO S-10	1800	85,8	2419	500	400	1234	1.167,90
2000	25.327.2000.21	2000X95,3 SDR21 ISO S-10	2000	95,3	3089	500	550	1417	1.659,20
2250	25.327.2250.21	2250X107,2 SDR21 ISO S-10	2250	107,2	3404	500	600	1514	2.282,50
2300	25.327.2300.21	2300X109,6 SDR21 ISO S-10	2300	109,6	3463	500	600	1586	2.435,00
2500	25.327.2500.21	2500X119,1 SDR21 ISO S-10	2500	119,1	3529	500	600	1662	2.947,50
2720	25.327.2720.21	2720X129,6 SDR21 ISO S-10	2720	129,6	4019	700	700	2015	4.111,60
2830	25.327.2830.21	2830X134,8 SDR21 ISO S-10	2830	134,8	4074	700	700	2037	4.497,90
3000	25.327.3000.21	3000X142,9 SDR21 ISO S-10	3000	142,9	4159	700	700	2073	5.142,80
800	25.327.0800.17	800X47,4 SDR17 ISO S-8	800	47,4	1919	500	400	1041	238,90
900	25.327.0900.17	900X53,3 SDR17 ISO S-8	900	53,3	2197	500	460	1118	324,80
1000	25.327.1000.17	1000X59,3 SDR17 ISO S-8	1000	59,3	2399	500	500	1176	422,60
1200	25.327.1200.17	1200X71,1 SDR17 ISO S-8	1200	71,1	2879	500	600	1311	678,80
1400	25.327.1400.17	1400X83,0 SDR17 ISO S-8	1400	83,0	2219	500	400	1157	812,80
1600	25.327.1600.17	1600X94,8 SDR17 ISO S-8	1600	94,8	2319	500	400	1195	1.096,60
1800	25.327.1800.17	1800X106,6 SDR17 ISO S-8	1800	106,6	2419	500	400	1234	1.432,30
2000	25.327.2000.17	2000X118,5 SDR17 ISO S-8	2000	118,5	3089	500	550	1417	2.036,00
2250	25.327.2250.17	2250X133,3 SDR17 ISO S-8	2250	133,3	3404	500	600	1514	2.801,10
2300	25.327.2300.17	2300X136,2 SDR 17 ISO S-8	2300	136,2	3463	500	600	1586	2.987,00
2500	25.330.2500.17	2500X148,1 SDR17 ISO S-8	2500	148,1	3529	500	600	1662	3.617,40
800	25.327.0800.11	800X72,6 SDR11 ISO S-5	800	72,6	1919	500	400	1041	352,60
900	25.327.0900.11	900X81,7 SDR11 ISO S-5	900	81,7	2197	500	460	1118	479,80
1000	25.327.1000.11	1000X90,8 SDR11 ISO S-5	1000	90,8	2399	500	500	1176	623,60
1200	25.327.1200.11	1200X108,9 SDR11 ISO S-5	1200	108,9	2879	500	600	1311	1.002,00
1400	25.327.1400.11	1400X127,0 SDR11 ISO S-5	1400	127,0	2219	500	400	1157	1.199,50
1600	25.327.1600.11	1600X145,2 SDR11 ISO S-5	1600	145,2	2319	500	400	1195	1.620,00

XXL Rohre  
XXL pipes

Formteile  
Fittings

Flansche & Zubehör  
Flanges & Accessories

Schweißtechnik  
Welding Technology



**Bogen 90°**

4 Segmente  
Abminderungsfaktor 0,8  
Stumpfschweissung  
PE 100 schwarz

**Bend 90°**

4 segments  
reduced pressure rating 0,8  
butt welding  
PE 100 black

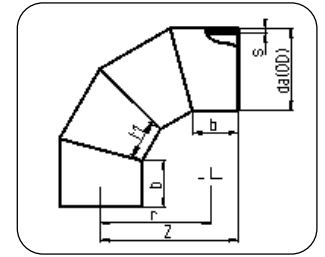
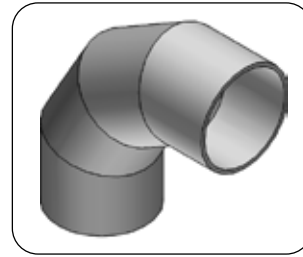

**Code 331**

Dimension	Code	Detail	da/OD [mm]	s [mm]	r [mm]	b [mm]	t1 [mm]	z [mm]	Gewicht/Weight [kg/m]
800	25.331.0800.41	800X19,6 SDR41 ISO S-20	800	19,6	1200	400	429	1385	111,90
900	25.331.0900.41	900X22,0 SDR41 ISO S-20	900	22,0	1350	400	482	1509	151,50
1000	25.331.1000.41	1000X24,5 SDR41 ISO S-20	1000	24,5	1500	500	536	1732	218,40
1200	25.331.1200.41	1200X29,4 SDR41 ISO S-20	1200	29,4	1800	500	643	1978	355,30
800	25.331.0800.33	800X24,5 SDR33 ISO S-16	800	24,5	1200	400	429	1385	138,90
900	25.331.0900.33	900X27,6 SDR33 ISO S-16	900	27,6	1350	400	482	1509	190,10
1000	25.331.1000.33	1000X30,6 SDR33 ISO S-16	1000	30,6	1500	500	536	1732	270,70
1200	25.331.1200.33	1200x36,7 SDR33 ISO S-16	1200	36,7	1800	500	643	1978	440,10
800	25.331.0800.26	800X30,6 SDR26 ISO S-12,5	800	30,6	1200	400	429	1385	171,80
900	25.331.0900.26	900X34,4 SDR26 ISO S-12,5	900	34,4	1350	400	482	1509	234,90
1000	25.331.1000.26	1000X38,2 SDR26 ISO S-12,5	1000	38,2	1500	500	536	1732	335,10
1200	25.331.1200.26	1200X45,9 SDR26 ISO S-12,5	1200	45,9	1800	500	643	1978	545,40
800	25.331.0800.21	800X38,1 SDR21 ISO S-10	800	38,1	1200	400	429	1385	211,70
900	25.331.0900.21	900X42,9 SDR21 ISO S-10	900	42,9	1350	400	482	1509	289,50
1000	25.331.1000.21	1000X47,7 SDR21 ISO S-10	1000	47,7	1500	500	536	1732	413,60
1200	25.331.1200.21	1200X57,2 SDR21 ISO S-10	1200	57,2	1800	500	643	1978	672,80
800	25.331.0800.17	800X47,4 SDR17 ISO S-8	800	47,4	1200	400	429	1385	259,80
900	25.331.0900.17	900X53,3 SDR17 ISO S-8	900	53,3	1350	400	482	1509	355,10
1000	25.331.1000.17	1000X59,3 SDR17 ISO S-8	1000	59,3	1500	500	536	1732	507,50
1200	25.331.1200.17	1200X71,1 SDR17 ISO S-8	1200	71,1	1800	500	643	1978	825,20
800	25.331.0800.11	800X72,6 SDR11 ISO S-5	800	72,6	1200	400	429	1385	383,40
900	25.331.0900.11	900X81,7 SDR11 ISO S-5	900	81,7	1350	400	482	1509	524,50
1000	25.331.1000.11	1000X90,8 SDR11 ISO S-5	1000	90,8	1500	500	536	1732	748,90
1200	25.331.1200.11	1200X108,9 SDR11 ISO S-5	1200	108,9	1800	500	643	1978	1.218,20



**Bogen 90°**

5 Segmente  
Abminderungsfaktor 0,8  
Stumpfschweissung  
PE 100 schwarz

**Bend 90°**

5 segments  
reduce pressure rating 0,8  
butt welding  
PE 100 black

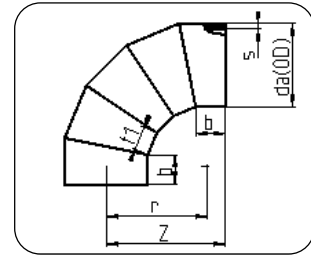
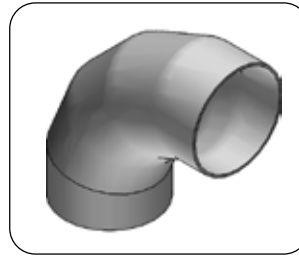

**Code 332**

Dimension	Code	Detail	da/OD [mm]	s [mm]	r [mm]	b [mm]	t1 [mm]	z [mm]	Gewicht/Weight [kg/m]
1400	25.332.1400.41	1400X34,3 SDR41 ISO S-20	1400	34,3	1705	500	400	2005	492,60
1600	25.332.1600.41	1600X39,2 SDR41 ISO S-20	1600	39,2	1920	500	446	2197	701,10
1800	2 x 45° / Code 25.330.1800.41								
2000	2 x 45° / Code 25.330.2000.41								
2250	2 x 45° / Code 25.330.2250.41								
2500	2 x 45° / Code 25.330.2500.41								
2720	2 x 45° / Code 25.330.2720.41								
2830	2 x 45° / Code 25.330.2830.41								
3000	2 x 45° / Code 25.330.3000.41								
3260	2 x 45° / Code 25.330.3260.41								
1400	25.332.1400.33	1400X42,9 SDR33 ISO S-16	1400	42,9	1705	500	400	2005	611,20
1600	25.332.1600.33	1600X49,0 SDR33 ISO S-16	1600	49,0	1920	500	446	2197	869,30
1800	2 x 45° / Code 25.330.1800.33								
2000	2 x 45° / Code 25.330.2000.33								
2250	2 x 45° / Code 25.330.2250.33								
2500	2 x 45° / Code 25.330.2500.33								
2720	2 x 45° / Code 25.330.2720.33								
2830	2 x 45° / Code 25.330.2830.33								
3000	2 x 45° / Code 25.330.3000.33								
3260	2 x 45° / Code 25.330.3260.33								
1400	25.332.1400.26	1400X53,5 SDR26 ISO S-12,5	1400	53,5	1705	500	400	2005	755,90
1600	25.332.1600.26	1600X61,2 SDR26 ISO S-12,5	1600	61,2	1920	500	446	2197	1.077,00
1800	2 x 45° / Code 25.330.1800.26								
2000	2 x 45° / Code 25.330.2000.26								
2250	2 x 45° / Code 25.330.2250.26								
2500	2 x 45° / Code 25.330.2500.26								
2720	2 x 45° / Code 25.330.2720.26								
2830	2 x 45° / Code 25.330.2830.26								
3000	2 x 45° / Code 25.330.3000.26								
3260	2 x 45° / Code 25.330.3260.26								
1400	25.332.1400.21	1400X66,7 SDR21 ISO S-10	1400	66,7	1705	500	400	2005	932,10
1600	25.332.1600.21	1600X76,2 SDR21 ISO S-10	1600	76,2	1920	500	446	2197	1.326,60
1800	2 x 45° / Code 25.330.1800.21								
2000	2 x 45° / Code 25.330.2000.21								
2250	2 x 45° / Code 25.330.2250.21								

**Bogen 90°**

5 Segmente  
Abminderungsfaktor 0,8  
Stumpfschweissung  
PE 100 schwarz

**Bend 90°**

5 segments  
reduce pressure rating 0,8  
butt welding  
PE 100 black

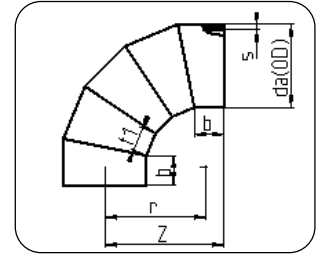
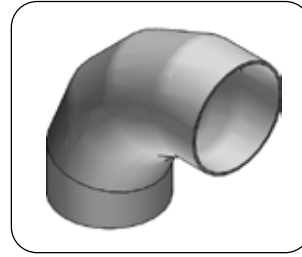

**Code 332**

Dimension	Code	Detail	da/OD [mm]	s [mm]	r [mm]	b [mm]	t1 [mm]	z [mm]	Gewicht/Weight [kg/m]
2500		2 x 45° / Code 25.330.2500.21							
2720		2 x 45° / Code 25.330.2720.21							
2830		2 x 45° / Code 25.330.2830.21							
3000		2 x 45° / Code 25.330.3000.21							
1400	25.332.1400.17	1400X83,0 SDR17 ISO S-8	1400	83,0	1705	500	400	2005	1.144,40
1600	25.332.1600.17	1600X94,8 SDR17 ISO S-8	1600	94,8	1920	500	446	2197	1.628,20
1800		2 x 45° / Code 25.330.1800.17							
2000		2 x 45° / Code 25.330.2000.17							
2250		2 x 45° / Code 25.330.2250.17							
2500		2 x 45° / Code 25.330.2500.17							
1400	25.332.1400.11	1400X127,0 SDR11 ISO S-5	1400	127,0	1705	500	400	2005	1.688,80
1600	25.332.1600.11	1600X145,2 SDR11 ISO S-5	1600	145,2	1920	500	446	2197	2.405,40

Ab d<sub>a</sub> 1800 realisierbar durch zwei 45° Bögen. Die Verschweißung erfolgt vor Ort auf der Baustelle.  
From OD 1800 realizeable by two 45° bends. The welding will be done on customers site.

**T-Stück segmentiert**

Abminderungsfaktor 0,6  
Stumpfschweissung  
PE 100 schwarz

**Tee segmented**

reduced pressure rating 0,6  
butt welding  
PE 100 black

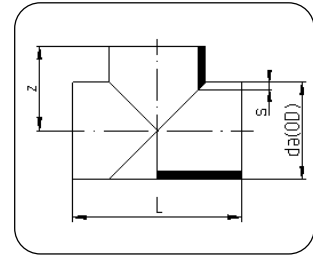
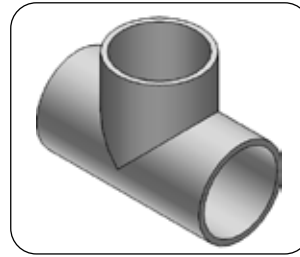

**Code 326**

Dimension	Code	Detail	da/OD [mm]	s [mm]	z [mm]	L [mm]	Gewicht/Weight [kg/m]
800	25.326.0800.41	800X19,6 SDR41 ISO S-20	800	19,6	700	1400	88,00
900	25.326.0900.41	900X22,0 SDR41 ISO S-20	900	22,0	950	1900	144,00
1000	25.326.1000.41	1000X24,5 SDR41 ISO S-20	1000	24,5	1000	2000	190,00
1200	25.326.1200.41	1200X29,4 SDR41 ISO S-20	1200	29,4	1100	2200	306,00
1400	25.326.1400.41	1400X34,3 SDR41 ISO S-20	1400	34,3	1200	2400	461,00
1600	25.326.1600.41	1600X39,2 SDR41 ISO S-20	1600	39,2	1300	2600	660,00
1800	25.326.1800.41	1800X44,0 SDR41 ISO S-20	1800	44,0	1400	2800	906,00
2000	25.326.2000.41	2000X48,9 SDR41 ISO S-20	2000	48,9	1500	3000	1.207,00
2250	25.326.2250.41	2250X55,0 SDR41 ISO S-20	2250	55,0	1625	3250	1.670,00
800	25.326.0800.33	800X24,5 SDR33 ISO S-16	800	24,5	700	1400	109,00
900	25.326.0900.33	900X27,6 SDR33 ISO S-16	900	27,6	950	1900	180,00
1000	25.326.1000.33	1000X30,6 SDR33 ISO S-16	1000	30,6	1000	2000	235,00
1200	25.326.1200.33	1200X36,7 SDR33 ISO S-16	1200	36,7	1100	2200	379,00
1400	25.326.1400.33	1400X42,9 SDR33 ISO S-16	1400	42,9	1200	2400	572,00
1600	25.326.1600.33	1600X49,0 SDR33 ISO S-16	1600	49,0	1300	2600	819,00
1800	25.326.1800.33	1800X55,1 SDR33 ISO S-16	1800	55,1	1400	2800	1.127,00
2000	25.326.2000.33	2000X61,2 SDR33 ISO S-16	2000	61,2	1500	3000	1.504,00
2250	25.326.2250.33	2250X68,9 SDR33 ISO S-16	2250	68,9	1625	3250	2.062,00
800	25.326.0800.26	800X30,6 SDR26 ISO S-12,5	800	30,6	700	1400	134,00
900	25.326.0900.26	900X34,4 SDR26 ISO S-12,5	900	34,4	950	1900	222,00
1000	25.326.1000.26	1000X38,2 SDR26 ISO S-12,5	1000	38,2	1000	2000	291,00
1200	25.326.1200.26	1200X45,9 SDR26 ISO S-12,5	1200	45,9	1100	2200	470,00
1400	25.326.1400.26	1400X53,5 SDR26 ISO S-12,5	1400	53,5	1200	2400	707,00
1600	25.326.1600.26	1600X61,2 SDR26 ISO S-12,5	1600	61,2	1300	2600	1.014,00
1800	25.326.1800.26	1800X68,8 SDR26 ISO S-12,5	1800	68,8	1400	2800	1.395,00
2000	25.326.2000.26	2000X76,4 SDR26 ISO S-12,5	2000	76,4	1500	3000	1.861,00
2250	25.326.2250.26	2250X86,0 SDR26 ISO S-12,5	2250	86,0	1625	3250	2.594,00
800	25.326.0800.21	800X38,1 SDR21 ISO S-10	800	38,1	700	1400	166,00
900	25.326.0900.21	900X42,9 SDR21 ISO S-10	900	42,9	950	1900	274,00
1000	25.326.1000.21	1000X47,7 SDR21 ISO S-10	1000	47,7	1000	2000	359,00
1200	25.326.1200.21	1200X57,2 SDR21 ISO S-10	1200	57,2	1100	2200	579,00
1400	25.326.1400.21	1400X66,7 SDR21 ISO S-10	1400	66,7	1200	2400	872,00
1600	25.326.1600.21	1600X76,2 SDR21 ISO S-10	1600	76,2	1300	2600	1.249,00
1800	25.326.1800.21	1800X85,8 SDR21 ISO S-10	1800	85,8	1400	2800	1.721,00
2000	25.326.2000.21	2000X95,3 SDR21 ISO S-10	2000	95,3	1500	3000	2.296,00
2250	25.326.2250.21	2250X107,2 SDR21 ISO S-10	2250	107,2	1625	3250	3.178,00
800	25.326.0800.17	800X47,4 SDR17 ISO S-8	800	47,4	700	1400	192,00
900	25.326.0900.17	900X53,3 SDR17 ISO S-8	900	53,3	950	1900	336,00

**T-Stück segmentiert**

Abminderungsfaktor 0,6  
Stumpfschweissung  
PE 100 schwarz

**Tee segmented**

reduced pressure rating 0,6  
butt welding  
PE 100 black

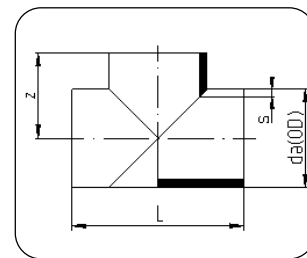
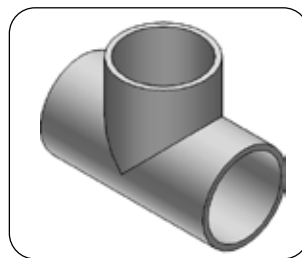

**Code 326**

Dimension	Code	Detail	da/OD [mm]	s [mm]	z [mm]	L [mm]	Gewicht/Weight [kg/m]
1000	25.326.1000.17	1000X59,3 SDR17 ISO S-8	1000	59,3	1000	2000	441,00
1200	25.326.1200.17	1200X71,1 SDR17 ISO S-8	1200	71,1	1100	2200	711,00
1400	25.326.1400.17	1400X83,0 SDR17 ISO S-8	1400	83,0	1200	2400	1.071,00
1600	25.326.1600.17	1600X94,8 SDR17 ISO S-8	1600	94,8	1300	2600	1.533,00
1800	25.326.1800.17	1800X106,6 SDR17 ISO S-8	1800	106,6	1400	2800	2.111,00
2000	25.326.2000.17	2000X118,4 SDR17 ISO S-8	2000	118,4	1500	3000	2.818,00
2250	25.326.2250.17	2250X133,3 SDR17 ISO S-8	2250	133,3	1625	3250	3.170,00
800	25.326.0800.11	800X72,6 SDR11 ISO S-5	800	72,6	700	1400	300,00
900	25.326.0900.11	900X81,7 SDR11 ISO S-5	900	81,7	950	1900	496,00
1000	25.326.1000.11	1000X90,8 SDR11 ISO S-5	1000	90,8	1000	2000	651,00
1200	25.326.1200.11	1200X108,9 SDR11 ISO S-5	1200	108,9	1100	2200	1.049,00
1400	25.326.1400.11	1400X127,0 SDR11 ISO S-5	1400	127,0	1200	2400	1.580,00
1600	25.326.1600.11	1600X145,2 SDR11 ISO S-5	1600	145,2	1300	2600	2.265,00

**T-Stück reduziert**  
geschweißt  
druckreduziert  
PE 100 schwarz

**Tee reduced**  
welded  
pressure reduced  
PE 100 black

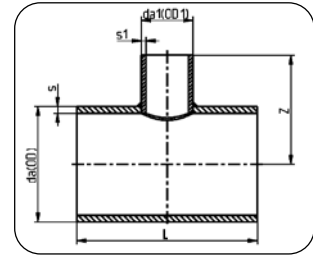
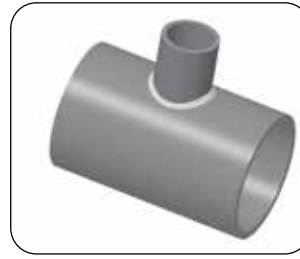

**Code 308**

Dimension	Code	da/OD [mm]	s [mm]	da1/OD1 [mm]	s1 [mm]	z [mm]	L [mm]	MOP [bar]	Gewicht/Weight [kg/m]
800/355	25.308.8035.41	800	19,6	400	9,8	900	1400	1,2	76,00
800/400	25.308.8040.41	800	19,6	450	11,0	900	1450	1,2	80,00
800/450	25.308.8045.41	800	19,6	450	11,0	900	1450	1,2	80,00
800/500	25.308.8050.41	800	19,6	500	12,3	900	1500	1,2	85,00
800/560	25.308.8056.41	800	19,6	560	13,7	900	1560	1,2	91,00
900/355	25.308.9035.41	900	22,0	355	8,7	950	1355	1,3	89,00
900/400	25.308.9040.41	900	22,0	400	9,8	950	1400	1,2	94,00
900/450	25.308.9045.41	900	22,0	450	11,0	950	1450	1,2	99,00
900/500	25.308.9050.41	900	22,0	500	12,3	950	1500	1,2	104,00
900/560	25.308.9056.41	900	22,0	560	13,7	950	1560	1,2	111,00
900/630	25.308.9063.41	900	22,0	630	15,4	950	1630	1,2	119,00
1000/400	25.308.1040.41	1000	24,5	400	9,8	1000	1400	1,3	114,00
1000/450	25.308.1045.41	1000	24,5	450	11,0	1000	1450	1,2	120,00
1000/500	25.308.1050.41	1000	24,5	500	12,3	1000	1500	1,2	126,00
1000/560	25.308.1056.41	1000	24,5	560	13,7	1000	1560	1,2	133,00
1000/630	25.308.1063.41	1000	24,5	630	15,4	1000	1630	1,2	143,00
1000/710	25.308.1071.41	1000	24,5	710	17,4	1000	1710	1,2	154,00
1200/400	25.308.1240.41	1200	29,4	400	9,8	1100	1400	1,3	161,00
1200/450	25.308.1245.41	1200	29,4	450	11,0	1100	1450	1,3	168,00
1200/500	25.308.1250.41	1200	29,4	500	12,3	1100	1500	1,3	176,00
1200/560	25.308.1256.41	1200	29,4	560	13,7	1100	1560	1,2	185,00
1200/630	25.308.1263.41	1200	29,4	630	15,4	1100	1630	1,2	197,00
1200/710	25.308.1271.41	1200	29,4	710	17,4	1100	1710	1,2	211,00
1200/800	25.308.1280.41	1200	29,4	800	19,6	1100	1800	1,2	227,00
1400/450	25.308.1445.41	1400	34,3	450	11,0	1200	1450	1,3	225,00
1400/500	25.308.1450.41	1400	34,3	500	12,3	1200	1500	1,3	235,00
1400/560	25.308.1456.41	1400	34,3	560	13,7	1200	1560	1,3	247,00
1400/630	25.308.1463.41	1400	34,3	630	15,4	1200	1630	1,2	261,00
1400/710	25.308.1471.41	1400	34,3	710	17,4	1200	1710	1,2	278,00
1400/800	25.308.1480.41	1400	34,3	800	19,6	1200	1800	1,2	298,00
1400/900	25.308.1490.41	1400	34,3	900	22,0	1200	1900	1,2	321,00
1400/1000	25.308.1410.41	1400	34,3	1000	24,5	1200	2000	1,2	344,00
1600/450	25.308.1645.41	1600	39,2	450	11,0	1300	1450	1,4	291,00
1600/500	25.308.1650.41	1600	39,2	500	12,3	1300	1500	1,3	303,00
1600/560	25.308.1656.41	1600	39,2	560	13,7	1300	1560	1,3	318,00
1600/630	25.308.1663.41	1600	39,2	630	15,4	1300	1630	1,3	335,00
1600/710	25.308.1671.41	1600	39,2	710	17,4	1300	1710	1,2	356,00
1600/800	25.308.1680.41	1600	39,2	800	19,6	1300	1800	1,2	380,00
1600/900	25.308.1690.41	1600	39,2	900	22,0	1300	1900	1,2	407,00
1600/1000	25.308.1610.41	1600	39,2	1000	24,5	1300	2000	1,2	435,00

**T-Stück reduziert**  
geschweißt  
druckreduziert  
PE 100 schwarz

**Tee reduced**  
welded  
pressure reduced  
PE 100 black

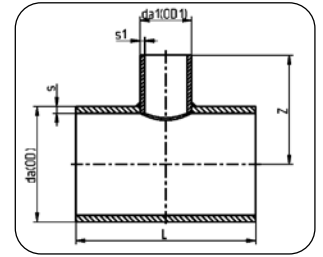
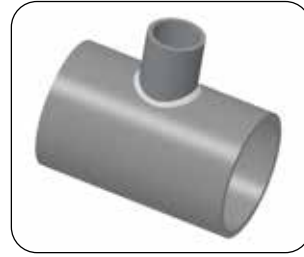

**Code 308**

Dimension	Code	da/OD [mm]	s [mm]	da1/OD1 [mm]	s1 [mm]	z [mm]	L [mm]	MOP [bar]	Gewicht/Weight [kg/m]
1800/450	25.308.1845.41	1800	44,0	450	11,0	1400	1450	1,4	365,00
1800/500	25.308.1850.41	1800	44,0	500	12,3	1400	1500	1,4	379,00
1800/560	25.308.1856.41	1800	44,0	560	13,7	1400	1560	1,4	397,00
1800/630	25.308.1863.41	1800	44,0	630	15,4	1400	1630	1,3	418,00
1800/710	25.308.1871.41	1800	44,0	710	17,4	1400	1710	1,3	443,00
1800/800	25.308.1880.41	1800	44,0	800	19,6	1400	1800	1,2	471,00
1800/900	25.308.1890.41	1800	44,0	900	22,0	1400	1900	1,2	503,00
1800/1000	25.308.1810.41	1800	44,0	1000	24,5	1400	2000	1,2	537,00
1800/1200	25.308.1812.41	1800	44,0	1200	29,4	1400	2200	1,2	606,00
2000/450	25.308.2045.41	2000	48,8	450	11,0	1500	1450	1,5	447,00
2000/500	25.308.2050.41	2000	48,8	500	12,3	1500	1500	1,4	464,00
2000/560	25.308.2056.41	2000	48,8	560	13,7	1500	1560	1,4	486,00
2000/630	25.308.2063.41	2000	48,8	630	15,4	1500	1630	1,3	511,00
2000/710	25.308.2071.41	2000	48,8	710	17,4	1500	1710	1,3	540,00
2000/800	25.308.2080.41	2000	48,8	800	19,6	1500	1800	1,3	573,00
2000/900	25.308.2090.41	2000	48,8	900	22,0	1500	1900	1,2	612,00
2000/1000	25.308.2010.41	2000	48,8	1000	24,5	1500	2000	1,2	651,00
2000/1200	25.308.2012.41	2000	48,8	1200	29,4	1500	2200	1,2	732,00
2000/1400	25.308.2014.41	2000	48,8	1400	34,3	1500	2400	1,2	817,00
2250/450	25.308.2245.41	2250	54,9	450	11,0	1600	1450	1,5	563,00
2250/500	25.308.2250.41	2250	54,9	500	12,3	1600	1500	1,5	587,00
2250/560	25.308.2256.41	2250	54,9	560	13,7	1600	1560	1,4	610,00
2250/630	25.308.2263.41	2250	54,9	630	15,4	1600	1630	1,4	640,00
2250/710	25.308.2271.41	2250	54,9	710	17,4	1600	1710	1,3	676,00
2250/800	25.308.2280.41	2250	54,9	800	19,6	1600	1800	1,3	716,00
2250/900	25.308.2290.41	2250	54,9	900	22,0	1625	1900	1,3	764,00
2250/1000	25.308.2210.41	2250	54,9	1000	24,5	1625	2000	1,2	811,00
2250/1200	25.308.2212.41	2250	54,9	1200	29,4	1625	2200	1,2	908,00
2250/1400	25.308.2214.41	2250	54,9	1400	34,3	1625	2400	1,2	1.009,00
2250/1600	25.308.2216.41	2250	54,9	1600	39,2	1625	2600	1,2	1.113,00
2300/450	25.308.2345.41	2300	56,3	450	11,0	1625	1450	1,5	578,00
2300/500	25.308.2350.41	2300	56,3	500	12,3	1625	1500	1,5	593,00
2300/560	25.308.2356.41	2300	56,3	560	13,7	1625	1560	1,4	630,00
2300/630	25.308.2363.41	2300	56,3	630	15,4	1625	1630	1,4	660,00
2300/710	25.308.2371.41	2300	56,3	710	17,4	1625	1710	1,3	685,00
2300/800	25.308.2380.41	2300	56,3	800	19,6	1625	1800	1,3	726,00
2300/900	25.308.2390.41	2300	56,3	900	22,0	1650	1900	1,3	775,00
2300/1000	25.308.2310.41	2300	56,3	1000	24,5	1650	2000	1,2	830,00
2300/1200	25.308.2312.41	2300	56,3	1200	29,5	1650	2200	1,2	920,00
2300/1400	25.308.2314.41	2300	56,3	1400	34,3	1650	2400	1,2	1.090,00

**T-Stück reduziert**  
geschweißt  
druckreduziert  
PE 100 schwarz

**Tee reduced**  
welded  
pressure reduced  
PE 100 black

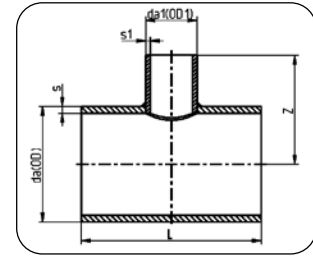
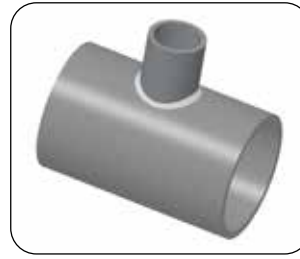

**Code 308**

Dimension	Code	da/OD [mm]	s [mm]	da1/OD1 [mm]	s1 [mm]	z [mm]	L [mm]	MOP [bar]	Gewicht/Weight [kg/m]
2300/1600	25.308.2316.41	2300	56,3	1600	39,2	1650	2600	1,2	1.130,00
2500/500	25.308.2550.41	2500	61,2	500	12,3	1750	1500	1,5	721,00
2500/560	25.308.2556.41	2500	61,2	560	13,7	1750	1560	1,5	753,00
2500/630	25.308.2563.41	2500	61,2	630	15,4	1750	1630	1,4	790,00
2500/710	25.308.2571.41	2500	61,2	710	17,4	1750	1710	1,4	933,00
2500/800	25.308.2580.41	2500	61,2	800	19,6	1750	1800	1,3	882,00
2500/900	25.308.2590.41	2500	61,2	900	22,0	1750	1900	1,3	937,00
2500/1000	25.308.2510.41	2500	61,2	1000	24,5	1750	2000	1,3	993,00
2500/1200	25.308.2512.41	2500	61,2	1200	29,4	1750	2200	1,2	1.108,00
2500/1400	25.308.2514.41	2500	61,2	1400	34,3	1750	2400	1,2	1.228,00
2500/1600	25.308.2516.41	2500	61,2	1600	39,2	1750	2600	1,2	1.350,00
2500/1800	25.308.2516.41	2500	61,2	1800	44,0	1750	2800	1,2	1.477,00
2500/2000	25.308.2516.41	2500	61,2	2000	48,9	1750	2800	1,2	1.513,00
800/355	25.308.8035.33	800	24,5	355	10,9	900	1355	1,6	89,00
800/400	25.308.8040.33	800	24,5	400	12,3	900	1400	1,6	94,00
800/450	25.308.8045.33	800	24,5	450	13,8	900	1450	1,6	99,00
800/500	25.308.8050.33	800	24,5	500	15,3	900	1500	1,6	105,00
800/560	25.308.8056.33	800	24,5	560	17,2	900	1560	1,6	112,00
900/355	25.308.9035.33	900	27,6	355	10,9	950	1355	1,7	111,00
900/400	25.308.9040.33	900	27,6	400	12,3	950	1400	1,6	116,00
900/450	25.308.9045.33	900	27,6	450	13,8	950	1450	1,6	123,00
900/500	25.308.9050.33	900	27,6	500	15,3	950	1500	1,6	129,00
900/560	25.308.9056.33	900	27,6	560	17,2	950	1560	1,6	138,00
900/630	25.308.9063.33	900	27,6	630	19,3	950	1630	1,6	148,00
1000/400	25.308.1040.33	1000	30,6	400	12,3	1000	1400	1,7	141,00
1000/450	25.308.1045.33	1000	30,6	450	13,8	1000	1450	1,6	148,00
1000/500	25.308.1050.33	1000	30,6	500	15,3	1000	1500	1,6	156,00
1000/560	25.308.1056.33	1000	30,6	560	17,2	1000	1560	1,6	165,00
1000/630	25.308.1063.33	1000	30,6	630	19,3	1000	1630	1,6	177,00
1000/710	25.308.1071.33	1000	30,6	710	21,8	1000	1710	1,6	190,00
1200/400	25.308.1240.33	1200	36,7	400	12,3	1100	1400	1,7	199,00
1200/450	25.308.1245.33	1200	36,7	450	13,8	1100	1450	1,7	208,00
1200/500	25.308.1250.33	1200	36,7	500	15,3	1100	1500	1,7	218,00
1200/560	25.308.1256.33	1200	36,7	560	17,2	1100	1560	1,6	229,00
1200/630	25.308.1263.33	1200	36,7	630	19,3	1100	1630	1,6	244,00
1200/710	25.308.1271.33	1200	36,7	710	21,8	1100	1710	1,6	261,00
1200/800	25.308.1280.33	1200	36,7	800	24,5	1100	1800	1,6	281,00
1400/450	25.308.1445.33	1400	42,9	450	13,8	1200	1450	1,8	279,00
1400/500	25.308.1450.33	1400	42,9	500	15,3	1200	1500	1,7	291,00
1400/560	25.308.1456.33	1400	42,9	560	17,2	1200	1560	1,7	306,00



**T-Stück reduziert**  
geschweißt  
druckreduziert  
PE 100 schwarz

**Tee reduced**  
welded  
pressure reduced  
PE 100 black

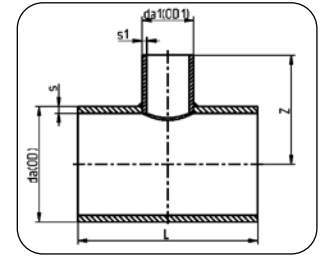
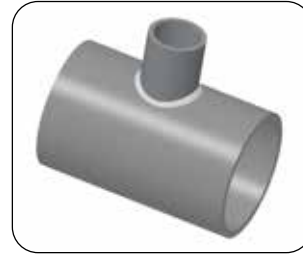

**Code 308**

Dimension	Code	da/OD [mm]	s [mm]	da1/OD1 [mm]	s1 [mm]	z [mm]	L [mm]	MOP [bar]	Gewicht/Weight [kg/m]
1400/630	25.308.1463.33	1400	42,9	630	19,3	1200	1630	1,6	324,00
1400/710	25.308.1471.33	1400	42,9	710	21,8	1200	1710	1,6	345,00
1400/800	25.308.1480.33	1400	42,9	800	24,5	1200	1800	1,6	369,00
1400/900	25.308.1490.33	1400	42,9	900	27,6	1200	1900	1,6	398,00
1400/1000	25.308.1410.33	1400	42,9	1000	30,6	1200	2000	1,6	427,00
1600/450	25.308.1645.33	1600	49,0	450	13,8	1300	1450	1,8	361,00
1600/500	25.308.1650.33	1600	49,0	500	15,3	1300	1500	1,8	376,00
1600/560	25.308.1656.33	1600	49,0	560	17,2	1300	1560	1,7	394,00
1600/630	25.308.1663.33	1600	49,0	630	19,3	1300	1630	1,7	416,00
1600/710	25.308.1671.33	1600	49,0	710	21,8	1300	1710	1,6	441,00
1600/800	25.308.1680.33	1600	49,0	800	24,5	1300	1800	1,6	471,00
1600/900	25.308.1690.33	1600	49,0	900	27,6	1300	1900	1,6	505,00
1600/1000	25.308.1610.33	1600	49,0	1000	30,6	1300	2000	1,6	540,00
1800/450	25.308.1845.33	1800	55,1	450	13,8	1400	1450	1,9	454,00
1800/500	25.308.1850.33	1800	55,1	500	15,3	1400	1500	1,8	472,00
1800/560	25.308.1856.33	1800	55,1	560	17,2	1400	1560	1,8	494,00
1800/630	25.308.1863.33	1800	55,1	630	19,3	1400	1630	1,7	520,00
1800/710	25.308.1871.33	1800	55,1	710	21,8	1400	1710	1,7	551,00
1800/800	25.308.1880.33	1800	55,1	800	24,5	1400	1800	1,6	586,00
1800/900	25.308.1890.33	1800	55,1	900	27,6	1400	1900	1,6	626,00
1800/1000	25.308.1810.33	1800	55,1	1000	30,6	1400	2000	1,6	668,00
1800/1200	25.308.1812.33	1800	55,1	1200	36,7	1400	2200	1,6	754,00
2000/450	25.308.2045.33	2000	61,2	450	13,8	1500	1450	1,9	557,00
2000/500	25.308.2050.33	2000	61,2	500	15,3	1500	1500	1,9	579,00
2000/560	25.308.2056.33	2000	61,2	560	17,2	1500	1560	1,8	605,00
2000/630	25.308.2063.33	2000	61,2	630	19,3	1500	1630	1,8	636,00
2000/710	25.308.2071.33	2000	61,2	710	21,8	1500	1710	1,7	672,00
2000/800	25.308.2080.33	2000	61,2	800	24,5	1500	1800	1,7	714,00
2000/900	25.308.2090.33	2000	61,2	900	27,6	1500	1900	1,6	762,00
2000/1000	25.308.2010.33	2000	61,2	1000	30,6	1500	2000	1,6	810,00
2000/1200	25.308.2012.33	2000	61,2	1200	36,7	1500	2200	1,6	911,00
2000/1400	25.308.2014.33	2000	61,2	1400	42,9	1500	2400	1,6	1.016,00
2250/450	25.308.2245.33	2250	68,2	450	13,8	1600	1450	2,0	695,00
2250/500	25.308.2250.33	2250	68,2	500	15,3	1600	1500	1,9	721,00
2250/560	25.308.2256.33	2250	68,2	560	17,2	1600	1560	1,9	753,00
2250/630	25.308.2263.33	2250	68,2	630	19,3	1600	1630	1,8	790,00
2250/710	25.308.2271.33	2250	68,2	710	21,8	1600	1710	1,8	834,00
2250/800	25.308.2280.33	2250	68,2	800	24,5	1600	1800	1,7	884,00
2250/900	25.308.2290.33	2250	68,2	900	27,6	1600	1900	1,7	940,00
2250/1000	25.308.2210.33	2250	68,2	1000	30,6	1600	2000	1,6	998,00

**T-Stück reduziert**  
geschweißt  
druckreduziert  
PE 100 schwarz

**Tee reduced**  
welded  
pressure reduced  
PE 100 black

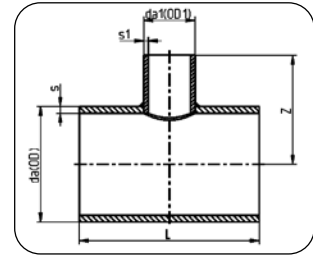
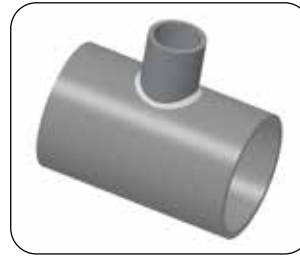

**Code 308**

Dimension	Code	da/OD [mm]	s [mm]	da1/OD1 [mm]	s1 [mm]	z [mm]	L [mm]	MOP [bar]	Gewicht/Weight [kg/m]
2250/1200	25.308.2212.33	2250	68,2	1200	36,7	1600	2200	1,6	1.117,00
2250/1400	25.308.2214.33	2250	68,2	1400	42,9	1600	2400	1,6	1.240,00
2250/1600	25.308.2216.33	2250	68,2	1600	49,0	1600	2600	1,6	1.367,00
2300/450	25.308.2345.33	2300	70,4	450	13,8	1625	1450	1,9	740,00
2300/500	25.308.2350.33	2300	70,4	500	15,3	1625	1500	1,9	770,00
2300/560	25.308.2356.33	2300	70,4	560	17,2	1625	1560	1,8	810,00
2300/630	25.308.2363.33	2300	70,4	630	19,3	1625	1630	1,8	850,00
2300/710	25.308.2371.33	2300	70,4	710	21,8	1625	1710	1,7	900,00
2300/800	25.308.2380.33	2300	70,4	800	24,5	1625	1800	1,7	930,00
2300/900	25.308.2390.33	2300	70,4	900	27,6	1650	1900	1,6	960,00
2300/1000	25.308.2310.33	2300	70,4	1000	30,6	1650	2000	1,6	1120,00
2300/1200	25.308.2312.33	2300	70,4	1200	36,7	1650	2200	1,6	1180,00
2300/1400	25.308.2314.33	2300	70,4	1400	42,9	1650	2400	1,6	1260,00
2300/1600	25.308.2316.33	2300	70,4	1600	49,0	1650	2600	1,6	1380,00
2500/500	25.308.2550.33	2500	76,5	500	15,3	1750	1500	2,0	895,00
2500/560	25.308.2556.33	2500	76,5	560	17,2	1750	1560	1,9	934,00
2500/630	25.308.2563.33	2500	76,5	630	19,3	1750	1630	1,9	980,00
2500/710	25.308.2571.33	2500	76,5	710	21,8	1750	1710	1,8	1.033,00
2500/800	25.308.2580.33	2500	76,5	800	24,5	1750	1800	1,8	1.094,00
2500/900	25.308.2590.33	2500	76,5	900	27,6	1750	1900	1,7	1.163,00
2500/1000	25.308.2510.33	2500	76,5	1000	30,6	1750	2000	1,7	1.232,00
2500/1200	25.308.2512.33	2500	76,5	1200	36,7	1750	2200	1,6	1.375,00
2500/1400	25.308.2514.33	2500	76,5	1400	42,9	1750	2400	1,6	1.523,00
2500/1600	25.308.2516.33	2500	76,5	1600	49,0	1750	2600	1,6	1.675,00
2500/1800	25.308.2518.33	2500	76,5	1800	55,1	1750	2800	1,6	1.832,00
2500/2000	25.308.2520.33	2500	76,5	2000	61,2	1750	2800	1,6	1.876,00
800/355	25.308.8035.26	800	30,6	355	13,6	900	1355	2,4	115,00
800/400	25.308.8040.26	800	30,6	400	15,3	900	1400	2,4	122,00
800/450	25.308.8045.26	800	30,6	450	17,2	900	1450	2,4	130,00
800/500	25.308.8050.26	800	30,6	500	19,1	900	1500	2,4	139,00
800/560	25.308.8056.26	800	30,6	560	21,4	900	1560	2,5	150,00
900/355	25.308.9035.26	900	34,4	355	13,6	950	1355	2,4	142,00
900/400	25.308.9040.26	900	34,4	400	15,3	950	1400	2,4	149,00
900/450	25.308.9045.26	900	34,4	450	17,2	950	1450	2,4	159,00
900/500	25.308.9050.26	900	34,4	500	19,1	950	1500	2,4	169,00
900/560	25.308.9056.26	900	34,4	560	21,4	950	1560	2,4	181,00
900/630	25.308.9063.26	900	34,4	630	24,1	950	1630	2,5	197,00
1000/400	25.308.1040.26	1000	38,2	400	15,3	1000	1400	2,4	180,00
1000/450	25.308.1045.26	1000	38,2	450	17,2	1000	1450	2,4	191,00

XXL Rohre  
XXL pipes

Formteile  
Fittings

Flansche & Zubehör  
Flanges & Accessories

Schweißtechnik  
Welding Technology

**T-Stück reduziert**  
geschweißt  
druckreduziert  
PE 100 schwarz

**Tee reduced**  
welded  
pressure reduced  
PE 100 black

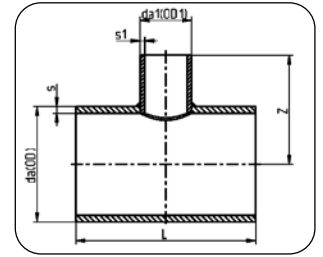
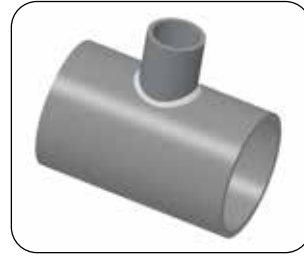

**Code 308**

Dimension	Code	da/OD [mm]	s [mm]	da1/OD1 [mm]	s1 [mm]	z [mm]	L [mm]	MOP [bar]	Gewicht/Weight [kg/m]
1000/500	25.308.1050.26	1000	38,2	500	19,1	1000	1500	2,4	202,00
1000/560	25.308.1056.26	1000	38,2	560	21,4	1000	1560	2,4	216,00
1000/630	25.308.1063.26	1000	38,2	630	24,1	1000	1630	2,4	233,00
1000/710	25.308.1071.26	1000	38,2	710	27,2	1000	1710	2,5	254,00
1200/400	25.308.1240.26	1200	45,9	400	15,3	1100	1400	2,5	252,00
1200/450	25.308.1245.26	1200	45,9	450	17,2	1100	1450	2,4	265,00
1200/500	25.308.1250.26	1200	45,9	500	19,1	1100	1500	2,4	279,00
1200/560	25.308.1256.26	1200	45,9	560	21,4	1100	1560	2,4	296,00
1200/630	25.308.1263.26	1200	45,9	630	24,1	1100	1630	2,4	316,00
1200/710	25.308.1271.26	1200	45,9	710	27,2	1100	1710	2,4	341,00
1200/800	25.308.1280.26	1200	45,9	800	30,6	1100	1800	2,4	371,00
1400/450	25.308.1445.26	1400	53,5	450	17,2	1200	1450	2,5	353,00
1400/500	25.308.1450.26	1400	53,5	500	19,1	1200	1500	2,4	369,00
1400/560	25.308.1456.26	1400	53,5	560	21,4	1200	1560	2,4	390,00
1400/630	25.308.1463.26	1400	53,5	630	24,1	1200	1630	2,4	415,00
1400/710	25.308.1471.26	1400	53,5	710	27,2	1200	1710	2,4	444,00
1400/800	25.308.1480.26	1400	53,5	800	30,6	1200	1800	2,4	480,00
1400/900	25.308.1490.26	1400	53,5	900	34,4	1200	1900	2,4	521,00
1400/1000	25.308.1410.26	1400	53,5	1000	38,2	1200	2000	2,5	564,00
1600/450	25.308.1645.26	1600	61,2	450	17,2	1300	1450	2,5	454,00
1600/500	25.308.1650.26	1600	61,2	500	19,1	1300	1500	2,5	474,00
1600/560	25.308.1656.26	1600	61,2	560	21,4	1300	1560	2,5	499,00
1600/630	25.308.1663.26	1600	61,2	630	24,1	1300	1630	2,4	529,00
1600/710	25.308.1671.26	1600	61,2	710	27,2	1300	1710	2,4	564,00
1600/800	25.308.1680.26	1600	61,2	800	30,6	1300	1800	2,4	606,00
1600/900	25.308.1690.26	1600	61,2	900	34,4	1300	1900	2,4	654,00
1600/1000	25.308.1610.26	1600	61,2	1000	38,2	1300	2000	2,4	704,00
1800/450	25.308.1845.26	1800	68,8	450	17,2	1400	1450	2,6	568,00
1800/500	25.308.1850.26	1800	68,8	500	19,1	1400	1500	2,5	592,00
1800/560	25.308.1856.26	1800	68,8	560	21,4	1400	1560	2,5	622,00
1800/630	25.308.1863.26	1800	68,8	630	24,1	1400	1630	2,5	657,00
1800/710	25.308.1871.26	1800	68,8	710	27,2	1400	1710	2,4	699,00
1800/800	25.308.1880.26	1800	68,8	800	30,6	1400	1800	2,4	747,00
1800/900	25.308.1890.26	1800	68,8	900	34,4	1400	1900	2,4	803,00
1800/1000	25.308.1810.26	1800	68,8	1000	38,2	1400	2000	2,4	862,00
1800/1200	25.308.1812.26	1800	68,8	1200	45,9	1400	2200	2,4	984,00
2000/450	25.308.2045.26	2000	76,4	450	17,2	1500	1450	2,6	696,00
2000/500	25.308.2050.26	2000	76,4	500	19,1	1500	1500	2,6	725,00
2000/560	25.308.2056.26	2000	76,4	560	21,4	1500	1560	2,5	760,00
2000/630	25.308.2063.26	2000	76,4	630	24,1	1500	1630	2,5	801,00

**T-Stück reduziert**  
geschweißt  
druckreduziert  
PE 100 schwarz

**Tee reduced**  
welded  
pressure reduced  
PE 100 black

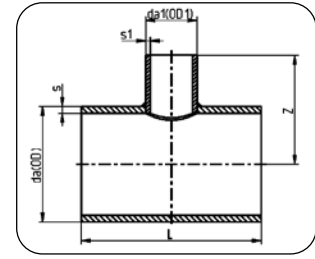
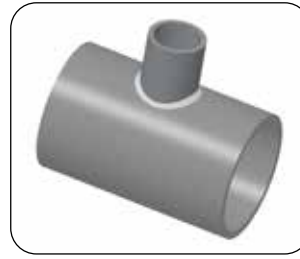

**Code 308**

Dimension	Code	da/OD [mm]	s [mm]	da1/OD1 [mm]	s1 [mm]	z [mm]	L [mm]	MOP [bar]	Gewicht/Weight [kg/m]
2000/710	25.308.2071.26	2000	76,4	710	27,2	1500	1710	2,4	850,00
2000/800	25.308.2080.26	2000	76,4	800	30,6	1500	1800	2,4	906,00
2000/900	25.308.2090.26	2000	76,4	900	34,4	1500	1900	2,4	971,00
2000/1000	25.308.2010.26	2000	76,4	1000	38,2	1500	2000	2,4	1.038,00
2000/1200	25.308.2012.26	2000	76,4	1200	45,9	1500	2200	2,4	1.178,00
2000/1400	25.308.2014.26	2000	76,4	1400	53,5	1500	2400	2,5	1.327,00
2250/450	25.308.2245.26	2250	86,6	500	19,1	1600	1560	2,6	950,00
2250/500	25.308.2250.26	2250	86,6	500	19,1	1600	1560	2,6	950,00
2250/560	25.308.2256.26	2250	86,6	560	21,4	1600	1560	2,6	957,00
2250/630	25.308.2263.26	2250	86,6	630	24,1	1600	1630	2,5	1.007,00
2250/710	25.308.2271.26	2250	86,6	710	27,2	1600	1710	2,5	1.065,00
2250/800	25.308.2280.26	2250	86,6	800	30,6	1600	1800	2,4	1.133,00
2250/900	25.308.2290.26	2250	86,6	900	34,4	1600	1900	2,4	1.209,00
2250/1000	25.308.2210.26	2250	86,6	1000	38,2	1600	2000	2,4	1.288,00
2250/1200	25.308.2212.26	2250	86,6	1200	45,9	1600	2200	2,4	1.451,00
2250/1400	25.308.2214.26	2250	86,6	1400	53,5	1600	2400	2,4	1.623,00
2250/1600	25.308.2216.26	2250	86,6	1600	61,2	1600	2600	2,4	1.803,00
2300/450	25.308.2345.26	2300	87,9	450	19,1	1625	1450	2,6	970,00
2300/500	25.308.2350.26	2300	87,9	500	19,2	1625	1500	2,6	980,00
2300/560	25.308.2356.26	2300	87,9	560	21,4	1625	1560	2,6	990,00
2300/630	25.308.2363.26	2300	87,9	630	24,1	1625	1630	2,5	1.020,00
2300/710	25.308.2371.26	2300	87,9	710	27,2	1625	1710	2,5	1.080,00
2300/800	25.308.2380.26	2300	87,9	800	30,2	1625	1800	2,4	1.150,00
2300/900	25.308.2390.26	2300	87,9	900	34,4	1650	1900	2,4	1.230,00
2300/1000	25.308.2310.26	2300	87,9	1000	38,2	1650	2000	2,4	1.300,00
2300/1200	25.308.2312.26	2300	87,9	1200	45,9	1650	2200	2,4	1.480,00
2300/1400	25.308.2314.26	2300	87,9	1400	53,5	1650	2400	2,4	1.660,00
2300/1600	25.308.2316.26	2300	87,9	1600	61,2	1650	2600	2,4	1.840,00
2500/500	25.308.2550.26	2500	95,5	500	19,1	1750	1500	2,6	1.108,00
2500/560	25.308.2556.26	2500	95,5	560	21,4	1750	1560	2,5	1.156,00
2500/630	25.308.2563.26	2500	95,5	630	24,1	1750	1630	2,5	1.213,00
2500/710	25.308.2571.26	2500	95,5	710	27,2	1750	1710	2,4	1.279,00
2500/800	25.308.2580.26	2500	95,5	800	30,6	1750	1800	2,3	1.354,00
2500/900	25.308.2590.26	2500	95,5	900	34,4	1750	1900	2,3	1.439,00
2500/1000	25.308.2510.26	2500	95,5	1000	38,2	1750	2000	2,2	1.525,00
2500/1200	25.308.2512.26	2500	95,5	1200	45,9	1750	2200	2,2	1.702,00
2500/1400	25.308.2514.26	2500	95,5	1400	53,5	1750	2400	2,1	1.885,00
2500/1600	25.308.2516.26	2500	95,5	1600	61,2	1750	2600	2,1	2.073,00
2500/1800	25.308.2518.26	2500	95,5	1800	68,8	1750	2800	2,1	2.267,00
2500/2000	25.308.2520.26	2500	95,5	2000	76,4	1750	2800	2,1	2.322,00

**T-Stück reduziert**  
geschweißt  
druckreduziert  
PE 100 schwarz

**Tee reduced**  
welded  
pressure reduced  
PE 100 black

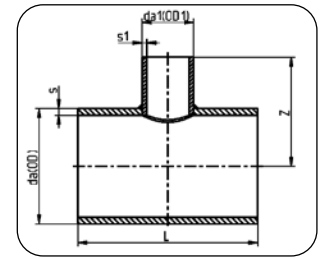
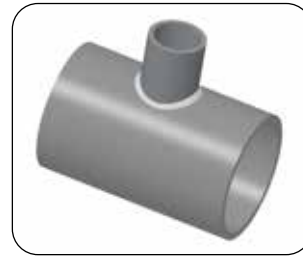

**Code 308**

Dimension	Code	da/OD [mm]	s [mm]	da1/OD1 [mm]	s1 [mm]	z [mm]	L [mm]	MOP [bar]	Gewicht/Weight [kg/m]
800/355	25.308.8035.21	800	38,1	355	16,9	900	1355	2,9	136,00
800/400	25.308.8040.21	800	38,1	400	19,1	900	1400	2,9	143,00
800/450	25.308.8045.21	800	38,1	450	21,5	900	1450	2,8	151,00
800/500	25.308.8050.21	800	38,1	500	23,9	900	1500	2,8	160,00
800/560	25.308.8056.21	800	38,1	560	26,7	900	1560	2,8	171,00
900/355	25.308.9035.21	900	42,9	355	16,9	950	1355	3,0	169,00
900/400	25.308.9040.21	900	42,9	400	19,1	950	1400	2,9	177,00
900/450	25.308.9045.21	900	42,9	450	21,5	950	1450	2,9	187,00
900/500	25.308.9050.21	900	42,9	500	23,9	950	1500	2,9	197,00
900/560	25.308.9056.21	900	42,9	560	26,7	950	1560	2,8	209,00
900/630	25.308.9063.21	900	42,9	630	30,0	950	1630	2,8	225,00
1000/400	25.308.1040.21	1000	47,7	400	19,1	1000	1400	3,0	215,00
1000/450	25.308.1045.21	1000	47,7	450	21,5	1000	1450	2,9	226,00
1000/500	25.308.1050.21	1000	47,7	500	23,9	1000	1500	2,9	238,00
1000/560	25.308.1056.21	1000	47,7	560	26,7	1000	1560	2,8	252,00
1000/630	25.308.1063.21	1000	47,7	630	30,0	1000	1630	2,8	269,00
1000/710	25.308.1071.21	1000	47,7	710	33,9	1000	1710	2,8	290,00
1200/400	25.308.1240.21	1200	57,2	400	19,1	1100	1400	3,1	304,00
1200/450	25.308.1245.21	1200	57,2	450	21,5	1100	1450	3,0	318,00
1200/500	25.308.1250.21	1200	57,2	500	23,9	1100	1500	3,0	333,00
1200/560	25.308.1256.21	1200	57,2	560	26,7	1100	1560	2,9	351,00
1200/630	25.308.1263.21	1200	57,2	630	30,0	1100	1630	2,9	372,00
1200/710	25.308.1271.21	1200	57,2	710	33,9	1100	1710	2,8	398,00
1200/800	25.308.1280.21	1200	57,2	800	38,1	1100	1800	2,8	429,00
1400/450	25.308.1445.21	1400	66,7	450	21,5	1200	1450	3,1	426,00
1400/500	25.308.1450.21	1400	66,7	500	23,9	1200	1500	3,0	444,00
1400/560	25.308.1456.21	1400	66,7	560	26,7	1200	1560	3,0	467,00
1400/630	25.308.1463.21	1400	66,7	630	30,0	1200	1630	2,9	494,00
1400/710	25.308.1471.21	1400	66,7	710	33,9	1200	1710	2,9	526,00
1400/800	25.308.1480.21	1400	66,7	800	38,1	1200	1800	2,8	563,00
1400/900	25.308.1490.21	1400	66,7	900	42,9	1200	1900	2,8	606,00
1400/1000	25.308.1410.21	1400	66,7	1000	47,7	1200	2000	2,8	651,00
1600/450	25.308.1645.21	1600	76,2	450	21,5	1300	1450	3,2	551,00
1600/500	25.308.1650.21	1600	76,2	500	23,9	1300	1500	3,1	573,00
1600/560	25.308.1656.21	1600	76,2	560	26,7	1300	1560	3,0	601,00
1600/630	25.308.1663.21	1600	76,2	630	30,0	1300	1630	3,0	634,00
1600/710	25.308.1671.21	1600	76,2	710	33,9	1300	1710	2,9	673,00
1600/800	25.308.1680.21	1600	76,2	800	38,1	1300	1800	2,9	718,00
1600/900	25.308.1690.21	1600	76,2	900	42,9	1300	1900	2,8	769,00
1600/1000	25.308.1610.21	1600	76,2	1000	47,7	1300	2000	2,8	823,00

**T-Stück reduziert**  
geschweißt  
druckreduziert  
PE 100 schwarz

**Tee reduced**  
welded  
pressure reduced  
PE 100 black

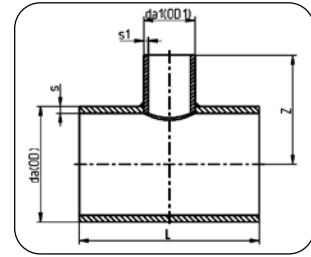
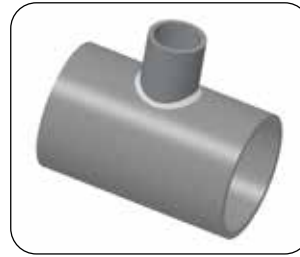

**Code 308**

Dimension	Code	da/OD [mm]	s [mm]	da1/OD1 [mm]	s1 [mm]	z [mm]	L [mm]	MOP [bar]	Gewicht/Weight [kg/m]
1800/450	25.308.1845.21	1800	85,8	450	21,5	1400	1450	3,3	692,00
1800/500	25.308.1850.21	1800	85,8	500	23,9	1400	1500	3,2	720,00
1800/560	25.308.1856.21	1800	85,8	560	26,7	1400	1560	3,1	753,00
1800/630	25.308.1863.21	1800	85,8	630	30,0	1400	1630	3,0	793,00
1800/710	25.308.1871.21	1800	85,8	710	33,9	1400	1710	3,0	840,00
1800/800	25.308.1880.21	1800	85,8	800	38,1	1400	1800	2,9	894,00
1800/900	25.308.1890.21	1800	85,8	900	42,9	1400	1900	2,9	955,00
1800/1000	25.308.1810.21	1800	85,8	1000	47,7	1400	2000	2,8	1.018,00
1800/1200	25.308.1812.21	1800	85,8	1200	57,2	1400	2200	2,8	1.150,00
2000/450	25.308.2045.21	2000	95,3	450	21,5	1500	1450	3,4	850,00
2000/500	25.308.2050.21	2000	95,3	500	23,9	1500	1500	3,3	883,00
2000/560	25.308.2056.21	2000	95,3	560	26,7	1500	1560	3,2	923,00
2000/630	25.308.2063.21	2000	95,3	630	30,0	1500	1630	3,1	971,00
2000/710	25.308.2071.21	2000	95,3	710	33,9	1500	1710	3,0	1.026,00
2000/800	25.308.2080.21	2000	95,3	800	38,1	1500	1800	3,0	1.090,00
2000/900	25.308.2090.21	2000	95,3	900	42,9	1500	1900	2,9	1.162,00
2000/1000	25.308.2010.21	2000	95,3	1000	47,7	1500	2000	2,9	1.236,00
2000/1200	25.308.2012.21	2000	95,3	1200	57,2	1500	2200	2,8	1.390,00
2000/1400	25.308.2014.21	2000	95,3	1400	66,7	1500	2400	2,8	1.551,00
2250/450	25.308.2245.21	2250	107,2	450	21,5	1600	1450	3,4	1.070,00
2250/500	25.308.2250.21	2250	107,2	500	23,9	1600	1500	3,4	1.111,00
2250/560	25.308.2256.21	2250	107,2	560	26,7	1600	1560	3,3	1.160,00
2250/630	25.308.2263.21	2250	107,2	630	30,0	1600	1630	3,2	1.217,00
2250/710	25.308.2271.21	2250	107,2	710	33,9	1600	1710	3,1	1.285,00
2250/800	25.308.2280.21	2250	107,2	800	38,1	1600	1800	3,0	1.361,00
2250/900	25.308.2290.21	2250	107,2	900	42,9	1600	1900	3,0	1.448,00
2250/1000	25.308.2210.21	2250	107,2	1000	47,7	1600	2000	2,9	1.537,00
2250/1200	25.308.2212.21	2250	107,2	1200	57,2	1600	2200	2,9	1.719,00
2250/1400	25.308.2214.21	2250	107,2	1400	66,7	1600	2400	2,8	1.908,00
2250/1600	25.308.2216.21	2250	107,2	1600	76,2	1600	2600	2,8	2.103,00
2300/450	25.308.2345.21	2300	109,6	450	21,5	1625	1450	3,4	1.090,00
2300/500	25.308.2350.21	2300	109,6	500	23,9	1625	1500	3,4	1.140,00
2300/560	25.308.2356.21	2300	109,6	560	26,7	1625	1560	3,3	1.190,00
2300/630	25.308.2363.21	2300	109,6	630	30,0	1625	1630	3,2	1.260,00
2300/710	25.308.2371.21	2300	109,6	710	33,9	1625	1710	3,1	1.310,00
2300/800	25.308.2380.21	2300	109,6	800	38,1	1625	1800	3,0	1.390,00
2300/900	25.308.2390.21	2300	109,6	900	42,9	1650	1900	3,0	1.480,00
2300/1000	25.308.2310.21	2300	109,6	1000	47,7	1650	2000	2,9	1.570,00
2300/1200	25.308.2312.21	2300	109,6	1200	57,2	1650	2200	2,9	1.740,00
2300/1400	25.308.2314.21	2300	109,6	1400	66,7	1650	2400	2,8	1.930,00



**T-Stück reduziert**  
geschweißt  
druckreduziert  
PE 100 schwarz

**Tee reduced**  
welded  
pressure reduced  
PE 100 black

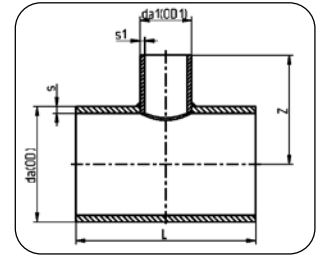
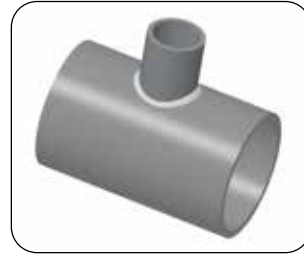

**Code 308**

Dimension	Code	da/OD [mm]	s [mm]	da1/OD1 [mm]	s1 [mm]	z [mm]	L [mm]	MOP [bar]	Gewicht/Weight [kg/m]
2300/1600	25.308.2316.21	2300	109,6	1600	76,2	1650	2600	2,8	2.150,00
2500/500	25.308.2550.21	2500	119,1	500	23,9	1750	1500	3,4	1.367,00
2500/560	25.308.2556.21	2500	119,1	560	26,7	1750	1560	3,4	1.427,00
2500/630	25.308.2563.21	2500	119,1	630	30,0	1750	1630	3,3	1.497,00
2500/710	25.308.2571.21	2500	119,1	710	33,9	1750	1710	3,2	1.578,00
2500/800	25.308.2580.21	2500	119,1	800	38,1	1750	1800	3,1	1.671,00
2500/900	25.308.2590.21	2500	119,1	900	42,9	1750	1900	3,0	1.775,00
2500/1000	25.308.2510.21	2500	119,1	1000	47,7	1750	2000	3,0	1.882,00
2500/1200	25.308.2512.21	2500	119,1	1200	57,2	1750	2200	2,9	2.100,00
2500/1400	25.308.2514.21	2500	119,1	1400	66,7	1750	2400	2,8	2.325,00
2500/1600	25.308.2516.21	2500	119,1	1600	76,2	1750	2600	2,8	2.557,00
2500/1800	25.308.2518.21	2500	119,1	1800	85,8	1750	2800	2,8	2.796,00
2500/2000	25.308.2520.21	2500	119,1	2000	95,3	1750	2800	2,9	2.863,00
800/355	25.308.8035.17	800	47,4	355	21,1	900	1355	4,2	169,00
800/400	25.308.8040.17	800	47,4	400	23,7	900	1400	4,2	179,00
800/450	25.308.8045.17	800	47,4	450	26,7	900	1450	4,2	190,00
800/500	25.308.8050.17	800	47,4	500	29,7	900	1500	4,3	202,00
800/560	25.308.8056.17	800	47,4	560	33,2	900	1560	4,3	217,00
900/355	25.308.9035.17	900	53,3	355	21,1	950	1355	4,2	210,00
900/400	25.308.9040.17	900	53,3	400	23,7	950	1400	4,2	221,00
900/450	25.308.9045.17	900	53,3	450	26,7	950	1450	4,2	233,00
900/500	25.308.9050.17	900	53,3	500	29,7	950	1500	4,2	247,00
900/560	25.308.9056.17	900	53,3	560	33,2	950	1560	4,3	264,00
900/630	25.308.9063.17	900	53,3	630	37,4	950	1630	4,3	284,00
1000/400	25.308.1040.17	1000	59,3	400	23,7	1000	1400	4,2	268,00
1000/450	25.308.1045.17	1000	59,3	450	26,7	1000	1450	4,2	282,00
1000/500	25.308.1050.17	1000	59,3	500	29,7	1000	1500	4,2	297,00
1000/560	25.308.1056.17	1000	59,3	560	33,2	1000	1560	4,2	316,00
1000/630	25.308.1063.17	1000	59,3	630	37,4	1000	1630	4,3	339,00
1000/710	25.308.1071.17	1000	59,3	710	42,1	1000	1710	4,3	367,00
1200/400	25.308.1240.17	1200	71,1	400	23,7	1100	1400	4,3	376,00
1200/450	25.308.1245.17	1200	71,1	450	26,7	1100	1450	4,2	394,00
1200/500	25.308.1250.17	1200	71,1	500	29,7	1100	1500	4,2	413,00
1200/560	25.308.1256.17	1200	71,1	560	33,2	1100	1560	4,2	437,00
1200/630	25.308.1263.17	1200	71,1	630	37,4	1100	1630	4,2	465,00
1200/710	25.308.1271.17	1200	71,1	710	42,1	1100	1710	4,3	500,00
1400/450	25.308.1445.17	1400	83,0	450	26,7	1200	1450	4,3	527,00
1400/500	25.308.1450.17	1400	83,0	500	29,7	1200	1500	4,3	551,00
1400/560	25.308.1456.17	1400	83,0	560	33,2	1200	1560	4,2	580,00
1400/630	25.308.1463.17	1400	83,0	630	37,4	1200	1630	4,2	615,00



**T-Stück reduziert**  
geschweißt  
druckreduziert  
PE 100 schwarz

**Tee reduced**  
welded  
pressure reduced  
PE 100 black

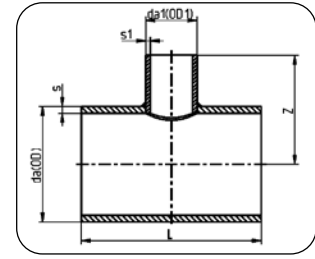
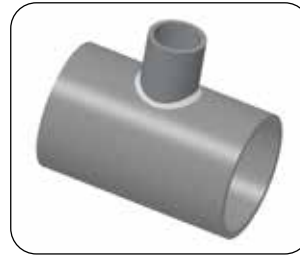

**Code 308**

Dimension	Code	da/OD [mm]	s [mm]	da1/OD1 [mm]	s1 [mm]	z [mm]	L [mm]	MOP [bar]	Gewicht/Weight [kg/m]
1400/710	25.308.1471.17	1400	83,0	710	42,1	1200	1710	4,2	656,00
1400/800	25.308.1480.17	1400	83,0	800	47,4	1200	1800	4,2	705,00
1600/450	25.308.1645.17	1600	94,8	560	26,7	1300	1450	4,3	695,00
1600/500	25.308.1650.17	1600	94,8	560	29,7	1300	1500	4,3	717,00
1600/560	25.308.1656.17	1600	94,8	560	33,2	1300	1560	4,3	744,00
1600/630	25.308.1663.17	1600	94,8	630	37,4	1300	1630	4,2	787,00
1600/710	25.308.1671.17	1600	94,8	710	42,1	1300	1710	4,2	837,00
1600/800	25.308.1680.17	1600	94,8	800	47,4	1300	1800	4,2	895,00
1800/450	25.308.1845.17	1800	106,6	450	26,7	1400	1450	4,4	854,00
1800/500	25.308.1850.17	1800	106,6	500	29,7	1400	1500	4,4	888,00
1800/560	25.308.1856.17	1800	106,6	560	33,2	1400	1560	4,3	931,00
1800/630	25.308.1863.17	1800	106,6	630	37,4	1400	1630	4,3	982,00
1800/710	25.308.1871.17	1800	106,6	710	42,1	1400	1710	4,2	1.041,00
1800/800	25.308.1880.17	1800	106,6	800	47,4	1400	1800	4,2	1.110,00
2000/450	25.308.2045.17	2000	118,5	450	26,7	1500	1450	4,5	1.048,00
2000/500	25.308.2050.17	2000	118,5	500	29,7	1500	1500	4,4	1.089,00
2000/560	25.308.2056.17	2000	118,5	560	33,2	1500	1560	4,4	1.140,00
2000/630	25.308.2063.17	2000	118,5	630	37,4	1500	1630	4,3	1.200,00
2000/710	25.308.2071.17	2000	118,5	710	42,1	1500	1710	4,3	1.270,00
2000/800	25.308.2080.17	2000	118,5	800	47,4	1500	1800	4,2	1.351,00
2250/450	25.308.2245.17	2250	132,4	450	26,7	1600	1450	4,6	1.310,00
2250/500	25.308.2250.17	2250	132,4	500	29,7	1600	1500	4,5	1.360,00
2250/560	25.308.2256.17	2250	132,4	560	33,2	1600	1560	4,4	1.421,00
2250/630	25.308.2263.17	2250	132,4	630	37,4	1600	1630	4,4	1.493,00
2250/710	25.308.2271.17	2250	132,4	710	42,1	1600	1710	4,3	1.577,00
2250/800	25.308.2280.17	2250	132,4	800	47,7	1600	1800	4,3	1.674,00
2300/450	25.308.2345.17	2300	136,2	450	26,7	1625	1450	4,6	1.350,00
2300/500	25.308.2350.17	2300	136,2	500	29,7	1625	1500	4,5	1.390,00
2300/560	25.308.2356.17	2300	136,2	560	33,2	1625	1560	4,4	1.460,00
2300/630	25.308.2363.17	2300	136,2	630	37,4	1625	1630	4,4	1.530,00
2300/710	25.308.2371.17	2300	136,2	710	42,1	1625	1710	4,3	1.590,00
2300/800	25.308.2380.17	2300	136,2	800	47,7	1625	1800	4,3	1.680,00
2500/500	25.308.2550.17	2500	141,6	500	29,7	1750	1500	4,6	1.683,00
2500/560	25.308.2556.17	2500	141,6	560	33,2	1750	1560	4,5	1.758,00
2500/630	25.308.2563.17	2500	141,6	630	37,4	1750	1630	4,5	1.846,00
2500/710	25.308.2571.17	2500	141,6	710	42,1	1750	1710	4,4	1.948,00
2500/800	25.308.2580.17	2500	141,6	800	47,4	1750	1800	4,3	2.064,00
2500/900	25.308.2590.17	2500	141,6	900	53,3	1750	1900	4,3	2.196,00
2500/1000	25.308.2510.17	2500	141,6	1000	59,3	1750	2000	4,3	2.331,00
2500/1200	25.308.2512.17	2500	141,6	1200	71,1	1750	2200	4,3	2.068,00

**T-Stück reduziert**  
geschweißt  
druckreduziert  
PE 100 schwarz

**Tee reduced**  
welded  
pressure reduced  
PE 100 black

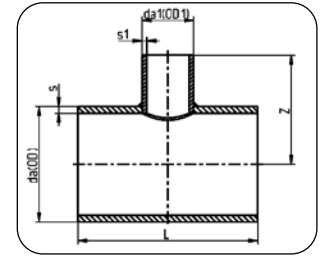
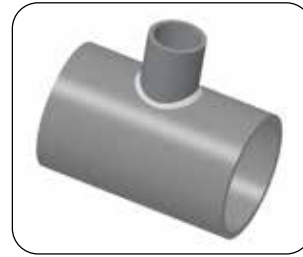

**Code 308**

Dimension	Code	da/OD [mm]	s [mm]	da1/OD1 [mm]	s1 [mm]	z [mm]	L [mm]	MOP [bar]	Gewicht/Weight [kg/m]
2500/1400	25.308.2514.17	2500	141,6	1400	83,0	1750	2400	4,3	2.896,00
2500/1600	25.308.2516.17	2500	141,6	1600	94,8	1750	2600	4,4	3.194,00
800/355	25.308.8035.11	800	72,6	355	32,2	900	1355	6,7	246,00
800/400	25.308.8040.11	800	72,6	400	36,3	900	1400	6,6	256,00
800/450	25.308.8045.11	800	72,6	450	40,9	900	1450	6,6	267,00
800/500	25.308.8050.11	800	72,6	500	45,4	900	1500	6,6	278,00
800/560	25.308.8056.11	800	72,6	560	50,8	900	1560	6,6	291,00
900/355	25.308.9035.11	900	81,7	355	32,2	950	1355	6,8	306,00
900/400	25.308.9040.11	900	81,7	400	36,3	950	1400	6,7	318,00
900/450	25.308.9045.11	900	81,7	450	40,9	950	1450	6,6	331,00
900/500	25.308.9050.11	900	81,7	500	45,4	950	1500	6,6	344,00
900/560	25.308.9056.11	900	81,7	560	50,8	950	1560	6,5	360,00
900/630	25.308.9063.11	900	81,7	630	57,2	950	1630	6,5	379,00
1000/400	25.308.1040.11	1000	90,8	400	36,3	1000	1400	6,8	387,00
1000/450	25.308.1045.11	1000	90,8	450	40,9	1000	1450	6,7	403,00
1000/500	25.308.1050.11	1000	90,8	500	45,4	1000	1500	6,6	418,00
1000/560	25.308.1056.11	1000	90,8	560	50,8	1000	1560	6,6	437,00
1000/630	25.308.1063.11	1000	90,8	630	57,2	1000	1630	6,5	459,00
1000/710	25.308.1071.11	1000	90,8	710	64,5	1000	1710	6,6	485,00
1200/400	25.308.1240.11	1200	108,9	400	36,3	1100	1400	6,9	547,00
1200/450	25.308.1245.11	1200	108,9	450	40,9	1100	1450	6,8	568,00
1200/500	25.308.1250.11	1200	108,9	500	45,4	1100	1500	6,7	590,00
1200/560	25.308.1256.11	1200	108,9	560	50,8	1100	1560	6,6	616,00
1200/630	25.308.1263.11	1200	108,9	630	57,2	1100	1630	6,6	646,00
1200/710	25.308.1271.11	1200	108,9	710	64,5	1100	1710	6,5	680,00
1400/450	25.308.1445.11	1400	127,0	450	40,9	1200	1450	7,0	764,00
1400/500	25.308.1450.11	1400	127,0	500	45,4	1200	1500	6,9	793,00
1400/560	25.308.1456.11	1400	127,0	560	50,8	1200	1560	6,8	826,00
1400/630	25.308.1463.11	1400	127,0	630	57,2	1200	1630	6,7	866,00
1400/710	25.308.1471.11	1400	127,0	710	64,5	1200	1710	6,6	911,00
1600/450	25.308.1645.11	1600	145,2	450	40,9	1300	1450	7,1	991,00
1600/500	25.308.1650.11	1600	145,2	500	45,4	1300	1500	7,0	1.027,00
1600/560	25.308.1656.11	1600	145,2	560	50,8	1300	1560	6,9	1.070,00
1600/630	25.308.1663.11	1600	145,2	630	57,2	1300	1630	6,8	1.121,00
1600/710	25.308.1671.11	1600	145,2	710	64,5	1300	1710	6,7	1.179,00

XXL Rohre  
XXL pipes

Formteile  
Fittings

Flansche & Zubehör  
Flanges & Accessories

Schweißtechnik  
Welding Technology

**T-Stück reduziert**  
stumpf geschweißt  
druckklassengerecht  
PE 100 schwarz

**Tee reduced**  
butt welded  
full pressure rated  
PE 100 black

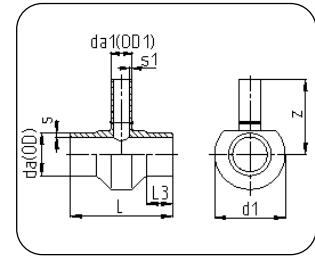
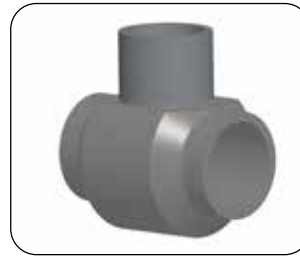

**Code 307**

Dimension	Code	da/OD [mm]	s [mm]	da1/OD1 [mm]	s1 [mm]	z [mm]	L [mm]	Gewicht/Weight [kg/m]
800/400	25.307.8040.33	800	24,5	400	12,3	725	579	auf Anfrage / on request
800/450	25.307.8045.33	800	24,5	450	13,8	730	635	
800/500	25.307.8050.33	800	24,5	500	15,3	730	691	
800/560	25.307.8056.33	800	24,5	560	17,2	730	759	
800/630	25.307.8063.33	800	24,5	630	19,3	935	837	
800/710	25.307.8071.33	800	24,5	710	21,8	935	927	
900/400	25.307.9040.33	900	27,6	400	12,3	775	579	
900/450	25.307.9045.33	900	27,6	450	13,8	780	691	
900/500	25.307.9050.33	900	27,6	500	15,3	780	1750	
900/560	25.307.9056.33	900	27,6	560	17,2	780	759	
900/630	25.307.9063.33	900	27,6	630	19,3	985	837	
900/710	25.307.9071.33	900	27,6	710	21,8	985	927	
900/800	25.307.9080.33	900	27,6	800	24,5	985	1028	
1000/400	25.307.1040.33	1000	30,6	400	12,3	825	589	
1000/450	25.307.1045.33	1000	30,6	450	13,8	830	645	
1000/500	25.307.1050.33	1000	30,6	500	15,3	830	701	
1000/560	25.307.1056.33	1000	30,6	560	17,2	830	769	
1000/630	25.307.1063.33	1000	30,6	630	19,3	1035	847	
1000/710	25.307.1071.33	1000	30,6	710	21,8	1035	937	
1000/800	25.307.1080.33	1000	30,6	800	24,5	1035	1038	
1200/400	25.307.1240.33	1200	36,7	400	12,3	925	589	
1200/450	25.307.1245.33	1200	36,7	450	13,8	930	645	
1200/500	25.307.1250.33	1200	36,7	500	15,3	930	701	
1200/560	25.307.1256.33	1200	36,7	560	17,2	930	769	
1200/630	25.307.1263.33	1200	36,7	630	19,3	1135	847	
1200/710	25.307.1271.33	1200	36,7	710	21,8	1135	937	
1200/800	25.307.1280.33	1200	36,7	800	24,5	1135	1038	
1400/400	25.307.1440.33	1400	42,9	400	12,3	1050	1620	
1400/500	25.307.1450.33	1400	42,9	500	15,3	1050	1720	
1400/630	25.307.1463.33	1400	42,9	630	19,3	1050	1850	
1400/710	25.307.1471.33	1400	42,9	710	21,8	1250	1930	
1400/800	25.307.1480.33	1400	42,9	800	24,5	1250	2020	
1400/1000	25.307.1410.33	1400	42,9	1000	30,6	1225	2270	

XXL Rohre  
XXL pipes

Formteile  
Fittings

Flansche & Zubehör  
Flanges & Accessories

Schweißtechnik  
Welding Technology

**T-Stück reduziert**  
stumpf geschweißt  
druckklassengerecht  
PE 100 schwarz

**Tee reduced**  
butt welded  
full pressure rated  
PE 100 black

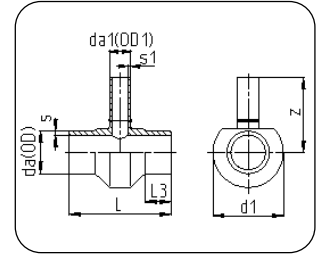
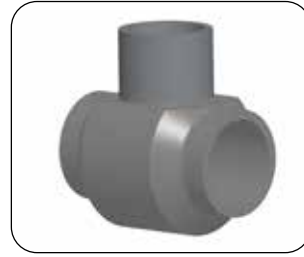

**Code 307**

Dimension	Code	da/OD [mm]	s [mm]	da1/OD1 [mm]	s1 [mm]	z [mm]	L [mm]	Gewicht/Weight [kg/m]
800/400	25.307.8040.26	800	30,6	400	15,3	720	591	auf Anfrage / on request
800/450	25.307.8045.26	800	30,6	450	17,2	725	649	
800/500	25.307.8050.26	800	30,6	500	19,1	725	706	
800/560	25.307.8056.26	800	30,6	560	21,4	725	776	
800/630	25.307.8063.26	800	30,6	630	24,1	930	856	
800/710	25.307.8071.26	800	30,6	710	27,2	930	949	
900/400	25.307.9040.26	900	34,4	400	15,3	770	591	
900/450	25.307.9045.26	900	34,4	450	17,2	775	649	
900/500	25.307.9050.26	900	34,4	500	19,1	775	706	
900/560	25.307.9056.26	900	34,4	560	21,4	775	776	
900/630	25.307.9063.26	900	34,4	630	24,1	980	856	
900/710	25.307.9071.26	900	34,4	710	27,2	980	949	
900/800	25.307.9080.26	900	34,4	800	30,6	980	1052	
1000/400	25.307.1040.26	1000	38,2	400	15,3	820	601	
1000/450	25.307.1045.26	1000	38,2	450	17,2	825	659	
1000/500	25.307.1050.26	1000	38,2	500	19,1	825	716	
1000/560	25.307.1056.26	1000	38,2	560	21,4	825	786	
1000/630	25.307.1063.26	1000	38,2	630	24,1	1030	867	
1000/710	25.307.1071.26	1000	38,2	710	27,2	1030	959	
1000/800	25.307.1080.26	1000	38,2	800	30,6	1030	1062	
1200/400	25.307.1240.26	1200	45,9	400	15,3	920	601	
1200/450	25.307.1245.26	1200	45,9	450	17,2	925	659	
1200/500	25.307.1250.26	1200	45,9	500	19,1	925	716	
1200/560	25.307.1256.26	1200	45,9	560	21,4	925	786	
1200/630	25.307.1263.26	1200	45,9	630	24,1	1130	866	
1200/710	25.307.1271.26	1200	45,9	710	27,2	1130	959	
1200/800	25.307.1280.26	1200	45,9	800	30,6	1130	1062	
1400/400	25.307.1440.26	1400	53,5	400	15,3	1050	1620	
1400/500	25.307.1450.26	1400	53,5	500	19,1	1050	1720	
1400/630	25.307.1463.26	1400	53,5	630	24,1	1050	1850	
1400/710	25.307.1471.26	1400	53,5	710	27,2	1250	1930	
1400/800	25.307.1480.26	1400	53,5	800	30,6	1250	2020	
1400/1000	25.307.1410.26	1400	53,5	1000	38,2	1225	2270	

**T-Stück reduziert**  
stumpf geschweißt  
druckklassengerecht  
PE 100 schwarz

**Tee reduced**  
butt welded  
full pressure rated  
PE 100 black

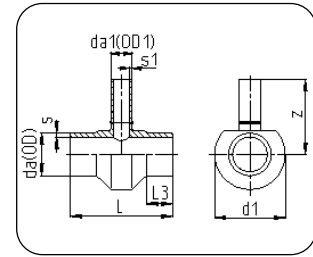

**Code 307**

Dimension	Code	da/OD [mm]	s [mm]	da1/OD1 [mm]	s1 [mm]	z [mm]	L [mm]	Gewicht/Weight [kg/m]
800/400	25.307.8040.21	800	38,1	400	19,1	725	591	auf Anfrage / on request
800/450	25.307.8045.21	800	38,1	450	21,5	730	649	
800/500	25.307.8050.21	800	38,1	500	23,9	730	706	
800/560	25.307.8056.21	800	38,1	560	26,7	730	776	
800/630	25.307.8063.21	800	38,1	630	30,0	935	856	
800/710	25.307.8071.21	800	38,1	710	33,9	935	949	
900/400	25.307.9040.21	900	42,9	400	19,1	775	591	
900/450	25.307.9045.21	900	42,9	450	21,5	780	649	
900/500	25.307.9050.21	900	42,9	500	23,9	780	706	
900/560	25.307.9056.21	900	42,9	560	26,7	780	776	
900/630	25.307.9063.21	900	42,9	630	30,0	985	856	
900/710	25.307.9071.21	900	42,9	710	33,9	985	949	
900/800	25.307.9080.21	900	42,9	800	38,1	985	1052	
1000/400	25.307.1040.21	1000	47,7	400	19,1	825	601	
1000/450	25.307.1045.21	1000	47,7	450	21,5	830	659	
1000/500	25.307.1050.21	1000	47,7	500	23,9	830	716	
1000/560	25.307.1056.21	1000	47,7	560	26,7	830	786	
1000/630	25.307.1063.21	1000	47,7	630	30,0	1035	866	
1000/710	25.307.1071.21	1000	47,7	710	33,9	1035	959	
1000/800	25.307.1080.21	1000	47,7	800	38,1	1035	1062	
1200/400	25.307.1240.21	1200	57,2	400	19,1	925	601	
1200/450	25.307.1245.21	1200	57,2	450	21,5	930	659	
1200/500	25.307.1250.21	1200	57,2	500	23,9	930	716	
1200/560	25.307.1256.21	1200	57,2	560	26,7	930	786	
1200/630	25.307.1213.21	1200	57,2	630	30,0	1135	866	
1200/710	25.307.1271.21	1200	57,2	710	33,9	1135	959	
1200/800	25.307.1280.21	1200	57,2	800	38,1	1135	1062	
1400/400	25.307.1440.21	1400	66,7	400	19,1	1050	1620	
1400/500	25.307.1450.21	1400	66,7	500	23,9	1050	1720	
1400/630	25.307.1463.21	1400	66,7	630	30	1050	1850	
1400/710	25.307.1471.21	1400	66,7	710	33,9	1250	1930	
1400/800	25.307.1480.21	1400	66,7	800	38,1	1250	2020	
1400/1000	25.307.1410.21	1400	66,7	1000	47,7	1225	2270	

XXL Rohre  
XXL pipes

Formteile  
Fittings

Flansche & Zubehör  
Flanges & Accessories

Schweißtechnik  
Welding Technology

**T-Stück reduziert**  
stumpf geschweißt  
druckklassengerecht  
PE 100 schwarz

**Tee reduced**  
butt welded  
full pressure rated  
PE 100 black

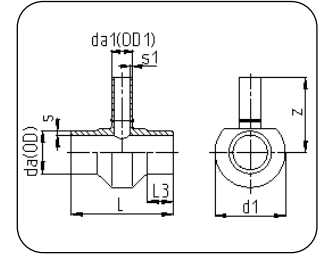
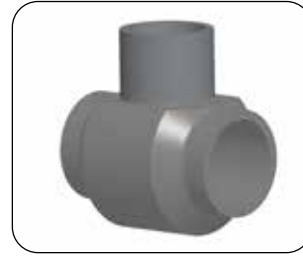

**Code 307**

Dimension	Code	da/OD [mm]	s [mm]	da1/OD1 [mm]	s1 [mm]	z [mm]	L [mm]	Gewicht/Weight [kg/m]
800/400	25.307.8040.17	800	47,4	400	23,7	730	625	auf Anfrage / on request
800/450	25.307.8045.17	800	47,4	450	26,7	735	687	
800/500	25.307.8050.17	800	47,4	500	29,7	735	749	
800/560	25.307.8056.17	800	47,4	560	33,2	735	823	
800/630	25.307.8063.17	800	47,4	630	37,4	940	910	
800/710	25.307.8071.17	800	47,4	710	42,1	940	1008	
900/400	25.307.9040.17	900	53,3	400	23,7	780	625	
900/450	25.307.9045.17	900	53,3	450	26,7	785	687	
900/500	25.307.9050.17	900	53,3	500	29,7	785	749	
900/560	25.307.9056.17	900	53,3	560	33,2	785	823	
900/630	25.307.9063.17	900	53,3	630	37,4	990	910	
900/710	25.307.9071.17	900	53,3	710	42,1	990	1008	
900/800	25.307.9080.17	900	53,3	800	47,4	990	1120	
1000/400	25.307.1040.17	1000	59,3	400	23,7	830	635	
1000/450	25.307.1045.17	1000	59,3	450	26,7	835	697	
1000/500	25.307.1050.17	1000	59,3	500	29,7	835	759	
1000/560	25.307.1056.17	1000	59,3	560	33,2	835	833	
1000/630	25.307.1063.17	1000	59,3	630	37,4	1040	920	
1000/710	25.307.1071.17	1000	59,3	710	42,1	1040	1018	
1000/800	25.307.1080.17	1000	59,3	800	47,4	1040	1130	
1200/400	25.307.1240.17	1200	71,1	400	23,7	930	635	
1200/450	25.307.1245.17	1200	71,1	450	26,7	935	697	
1200/500	25.307.1250.17	1200	71,1	500	29,7	935	759	
1200/560	25.307.1256.17	1200	71,1	560	33,2	935	833	
1200/630	25.307.1173.17	1200	71,1	630	37,4	1140	920	
1200/710	25.307.1271.17	1200	71,1	710	42,1	1140	1018	
1200/800	25.307.1280.17	1200	71,1	800	47,4	1140	1130	
1400/400	25.307.1440.17	1400	83,0	400	23,7	1050	1620	
1400/500	25.307.1450.17	1400	83,0	500	29,7	1050	1720	
1400/630	25.307.1463.17	1400	83,0	630	37,4	1050	1850	
1400/710	25.307.1471.17	1400	83,0	710	42,1	1250	1930	
1400/800	25.307.1480.17	1400	83,0	800	47,4	1250	2020	
1400/1000	25.307.1410.17	1400	83,0	1000	59,3	1225	2270	

**T-Stück reduziert**  
stumpf geschweißt  
druckklassengerecht  
PE 100 schwarz

**Tee reduced**  
butt welded  
full pressure rated  
PE 100 black

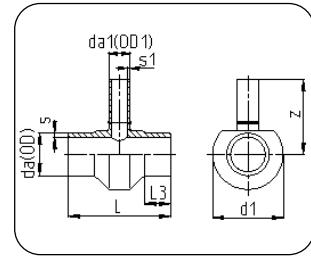
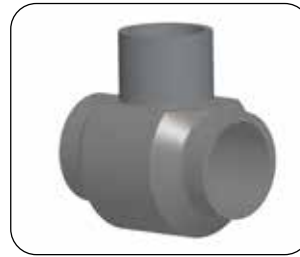

**Code 307**

Dimension	Code	da/OD [mm]	s [mm]	da1/OD1 [mm]	s1 [mm]	z [mm]	L [mm]	Gewicht/Weight [kg/m]
800/400	25.307.8040.11	800	72,6	400	36,3	730	675	auf Anfrage / on request
800/450	25.307.8045.11	800	72,6	450	40,9	735	744	
800/500	25.307.8050.11	800	72,6	500	45,4	735	812	
800/560	25.307.8056.11	800	72,6	560	50,8	735	893	
800/630	25.307.8063.11	800	72,6	630	57,2	940	989	
800/710	25.307.8071.11	800	72,6	710	64,5	940	1098	
900/400	25.307.9040.11	900	81,7	400	36,3	780	675	
900/450	25.307.9045.11	900	81,7	450	40,9	785	744	
900/500	25.307.9050.11	900	81,7	500	45,4	785	812	
900/560	25.307.9056.11	900	81,7	560	50,8	785	893	
900/630	25.307.9063.11	900	81,7	630	57,2	990	989	
900/710	25.307.9071.11	900	81,7	710	64,5	990	1098	
900/800	25.307.9080.11	900	81,7	800	72,6	990	1220	
1000/400	25.307.1040.11	1000	90,8	400	36,3	830	685	
1000/450	25.307.1045.11	1000	90,8	450	40,9	835	754	
1000/500	25.307.1050.11	1000	90,8	500	45,4	835	822	
1000/560	25.307.1056.11	1000	90,8	560	50,8	835	903	
1000/630	25.307.1063.11	1000	90,8	630	57,2	1040	999	
1000/710	25.307.1071.11	1000	90,8	710	64,5	1040	1108	
1000/800	25.307.1080.11	1000	90,8	800	72,6	1040	1230	
1200/400	25.307.1240.11	1200	108,9	400	36,3	930	685	
1200/450	25.307.1245.11	1200	108,9	450	40,9	935	754	
1200/500	25.307.1250.11	1200	108,9	500	45,4	935	822	
1200/560	25.307.1256.11	1200	108,9	560	50,8	935	903	
1200/630	25.307.1263.11	1200	108,9	630	57,2	1140	999	
1200/710	25.307.1271.11	1200	108,9	710	64,5	1140	1108	
1200/800	25.307.1280.11	1200	108,9	800	72,6	1140	1230	
1400/400	25.307.1440.11	1400	127,0	400	36,3	1050	1620	
1400/500	25.307.1450.11	1400	127,0	500	45,4	1050	1720	
1400/630	25.307.1463.11	1400	127,0	630	57,2	1050	1850	
1400/710	25.307.1471.11	1400	127,0	710	64,5	1250	1930	
1400/800	25.307.1480.11	1400	127,0	800	72,6	1250	2020	
1400/1000	25.307.1410.11	1400	127,0	1000	90,8	1225	2270	

Verlängerungen auf Anfrage möglich / Elongations available on request.

XXL Rohre  
XXL pipes

Formteile  
Fittings

Flansche & Zubehör  
Flanges & Accessories

Schweißtechnik  
Welding Technology



**E-Muffe**

mechanisch gefertigt  
Heizwendelschweissung  
PE 100 schwarz

**E-Coupler**

machined  
Electro-fusion  
PE 100 black

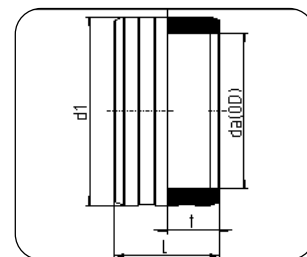

**Code 373**

Dimension	Code	Detail	da/OD [mm]	L [mm]	d1 [mm]	t [mm]	Gewicht/Weight [kg/m]
800	70.373.0800.17	800 SDR 33/26/21/17 MOP 10bar	800	500,0	915,0	250,0	73,50
900	70.373.0900.17	900 SDR 33/26/21/17 MOP 10bar	900	510,0	1025,0	255,0	90,50
1000	70.373.1000.17	1000 SDR 33/26/21/17 MOP 10bar	1000	530,0	1140,0	265,0	115,00
1200	70.373.1200.17	1200 SDR 33/26/21/17 MOP 10 bar	1200	540,0	1365,0	270,0	169,00
1400	70.373.1400.17	1400 SDR 33/26/21/17 MOP 10bar	1400	550,0	1590,0	275,0	235,00
800	70.373.0800.11	800 SDR 17-11 MOP 16bar	800	500,0	980,0	250,0	128,60
900	70.373.0900.11	900 SDR 17-11 MOP 16bar	900	510,0	1105,0	255,0	124,00

**Stutzenschelle**  
mechanisch gefertigt  
PE 100 schwarz

**Spigot Saddle**  
machined  
PE 100 black

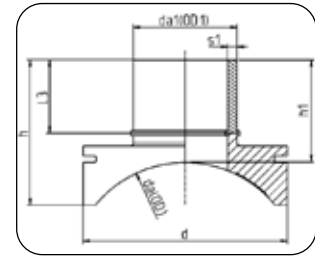
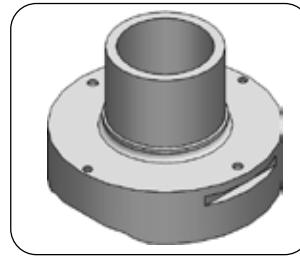

**Code 289**

Dimension	Code	Detail	da/OD [mm]	da1/OD1 [mm]	h [mm]	h1 [mm]	d [mm]	s1 [mm]	l3 [mm]	Gewicht/Weight [kg/m]
800/160	25.289.8016.17	800/160 SDR17 ISO S-8	800	160	196	163	315	9,5	113	2,7
800/200	25.289.8020.17	800/200 SDR17 ISO S-8	800	200	231	182	400	11,9	127	5,2
800/315	25.289.8031.17	800/315 SDR17 ISO S-8	800	315	315	225	560	18,7	165	14,9
800/355	25.289.8035.17	800/355 SDR17 ISO S-8	800	355	356	239	630	21,1	179	21,4
800/400	25.289.8040.17	800/400 SDR17 ISO S-8	800	400	372	259	630	23,7	194	23,4
800/450	25.289.8045.17	800/450 SDR17 ISO S-8	800	450	425	280	710	26,7	210	35,4
800/500	25.289.8050.17	800/500 SDR17 ISO S-8	800	500	485	302	800	29,7	227	53,4
900/500	25.289.9050.17	900/500 SDR17 ISO S-8	900	500	468	302	800	29,7	227	49,9
1000/500	25.289.1050.17	1000/500 SDR17 ISO S-8	1000	500	453	302	800	29,7	227	47,4
1200/110	25.289.1211.17	1200/110 SDR17 ISO S-8	1200	110	161	147	250	6,6	97	1,4
1200/315	25.289.1231.17	1200/315 SDR17 ISO S-8	1200	315	286	225	560	18,7	165	12,9
1200/500	25.289.1250.17	1200/500 SDR17 ISO S-8	1200	500	430	302	800	29,7	227	43,7
1200/630	25.289.1263.17	1200/630 SDR17 ISO S-8	1200	630	541	330	1000	37,4	270	94,6
1400/450	25.289.1445.17	1400/450 SDR17 ISO S-8	1400	450	367	280	710	26,7	210	28,2
1400/500	25.289.1450.17	1400/500 SDR17 ISO S-8	1400	500	413	302	800	29,7	227	41,1
1600/400	25.289.1640.17	1600/400 SDR17 ISO S-8	1600	400	318	259	630	23,7	194	18,4
1600/450	25.289.1645.17	1600/450 SDR17 ISO S-8	1600	450	356	280	710	26,7	210	27,0
1600/500	25.289.1650.17	1600/500 SDR17 ISO S-8	1600	500	400	302	800	29,7	227	39,3
1600/560	25.289.1656.17	1600/560 SDR17 ISO S-8	1600	560	450	330	900	33,2	250	57,2
1600/630	25.289.1656.17	1600/630 SDR17 ISO S-8	1600	630	499	330	1000	37,4	270	83,6
1600/710	25.289.1671.17	1600/710 SDR17 ISO S-8	1600	710	545	365	1120	42,1	270	118,5
1600/800	25.289.1680.17	1600/800 SDR17 ISO S-8	1600	800	555	370	1120	47,4	270	122,7
1600/900	25.289.1690.17	1600/900 SDR17 ISO S-8	1600	900	647	385	1350	53,3	275	209,4
1800/355	25.289.1835.17	1800/355 SDR17 ISO S-8	1800	355	294	239	630	21,1	179	15,8
1800/400	25.289.1840.17	1800/400 SDR17 ISO S-8	1800	400	312	259	630	23,7	194	17,9
1800/500	25.289.1850.17	1800/500 SDR17 ISO S-8	1800	500	389	302	800	29,7	227	38,0
1800/560	25.289.1856.17	1800/560 SDR17 ISO S-8	1800	560	437	330	900	33,2	250	54,9
1800/630	25.289.1863.17	1800/630 SDR17 ISO S-8	1800	630	484	330	1000	37,4	270	80,2
1800/710	25.289.1871.17	1800/710 SDR17 ISO S-8	1800	710	526	365	1120	42,1	270	112,8
1800/800	25.289.1880.17	1800/800 SDR17 ISO S-8	1800	800	536	370	1120	47,4	270	117,2
1800/900	25.289.1890.17	1800/900 SDR17 ISO S-8	1800	900	621	385	1350	53,3	275	197,4
2000/500	25.289.2050.17	2000/500 SDR17 ISO S-8	2000	500	381	302	800	29,7	227	36,9
2000/560	25.289.2056.17	2000/560 SDR17 ISO S-8	2000	560	427	330	900	33,2	250	53,2
2000/630	25.289.2063.17	2000/630 SDR17 ISO S-8	2000	630	473	330	1000	37,4	270	77,5
2000/710	25.289.2071.17	2000/710 SDR17 ISO S-8	2000	710	511	365	1120	42,1	270	108,5
2000/800	25.289.2080.17	2000/800 SDR17 ISO S-8	2000	800	520	370	1120	47,4	270	113,0
2000/900	25.289.2090.17	2000/900 SDR17 ISO S-8	2000	900	600	385	1350	53,3	275	188,2
2250/500	25.289.2250.17	2250/500 SDR17 ISO S-8	2250	500	372	302	800	29,7	227	35,8
2250/560	25.289.2256.17	2250/560 SDR17 ISO S-8	2250	560	417	330	900	33,2	250	51,4

**Stutzenschelle**  
mechanisch gefertigt  
PE 100 schwarz

**Spigot Saddle**  
machined  
PE 100 black

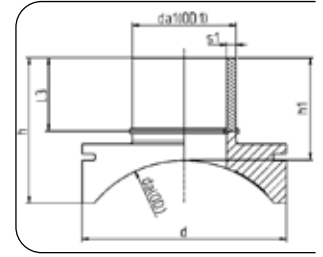
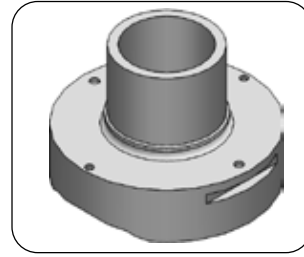

**Code 289**

Dimension	Code	Detail	da/OD [mm]	da1/OD1 [mm]	h [mm]	h1 [mm]	d [mm]	s1 [mm]	l3 [mm]	Gewicht/Weight [kg/m]
2250/630	25.289.2263.17	2250/630 SDR17 ISO S-8	2250	630	460	330	1000	37,4	270	74,9
2250/710	25.289.2271.17	2250/710 SDR17 ISO S-8	2250	710	496	365	1120	42,1	270	104,2
2250/800	25.289.2280.17	2250/800 SDR17 ISO S-8	2250	800	504	370	1120	47,4	270	108,8
2250/900	25.289.2290.17	2250/900 SDR17 ISO S-8	2250	900	577	385	1350	53,3	275	179,3
2300/500	25.289.2350.17	2300/500 SDR17 ISO S-8	2300	500	372	302	800	29,7	227	45,5
2300/560	25.289.2356.17	2300/560 SDR17 ISO S-8	2300	560	417	330	900	33,2	250	61,5
2300/630	25.289.2363.17	2300/630 SDR17 ISO S-8	2300	630	460	330	1000	37,4	270	85,4
2300/710	25.289.2371.17	2300/710 SDR17 ISO S-8	2300	710	496	365	1120	42,1	270	115,5
2300/800	25.289.2380.17	2300/800 SDR17 ISO S-8	2300	800	504	370	1120	47,7	270	131,5
2300/900	25.289.2390.17	2300/900 SDR17 ISO S-8	2300	800	577	385	1350	53,3	275	197,3
2500/500	25.289.2550.17	2500/500 SDR17 ISO S-8	2500	500	372	302	800	29,7	227	35,0
2500/560	25.289.2556.17	2500/560 SDR17 ISO S-8	2500	560	408	330	900	33,2	250	50,1
2500/630	25.289.2563.17	2500/630 SDR17 ISO S-8	2500	630	451	330	1000	37,4	270	72,8
2500/710	25.289.2571.17	2500/710 SDR17 ISO S-8	2500	710	483	365	1120	42,1	270	100,8
2500/800	25.289.2580.17	2500/800 SDR17 ISO S-8	2500	800	491	370	800	47,4	270	105,6
2500/900	25.289.2590.17	2500/900 SDR17 ISO S-8	2500	900	559	385	1350	53,3	275	172,3
800/63	25.289.8063.11	800/63 SDR11 ISO S-5	800	63	141	128	200	5,8	78	0,9
800/90	25.289.8090.11	800/90 SDR11 ISO S-5	800	90	157	144	200	8,2	94	1,0
800/110	25.289.8011.11	800/110 SDR11 ISO S-5	800	110	166	147	250	10	97	1,6
800/125	25.289.8012.11	800/125 SDR11 ISO S-5	800	125	176	152	280	11,4	102	2,1
800/160	25.289.8016.11	800/160 SDR11 ISO S-5	800	160	196	163	315	14,6	113	3,0
800/180	25.289.8018.11	800/180 SDR11 ISO S-5	800	180	213	175	355	16,4	120	4,2
800/200	25.289.8020.11	800/200 SDR11 ISO S-5	800	200	231	182	400	18,2	127	5,6
800/225	25.289.8022.11	800/225 SDR11 ISO S-5	800	225	237	190	400	20,5	135	6,0
800/250	25.289.8025.11	800/250 SDR11 ISO S-5	800	250	261	199	450	22,7	144	8,2
800/280	25.289.8028.11	800/280 SDR11 ISO S-5	800	280	285	209	500	25,4	154	11,2
800/315	25.289.8031.11	800/315 SDR11 ISO S-5	800	315	315	225	560	28,6	165	16,5
800/355	25.289.8035.11	800/355 SDR11 ISO S-5	800	355	356	239	630	32,2	179	23,5
800/400	25.289.8040.11	800/400 SDR11 ISO S-5	800	400	372	259	630	36,3	194	26,3
800/450	25.289.8045.11	800/450 SDR11 ISO S-5	800	450	425	280	710	40,9	210	39,4
800/500	25.289.8050.11	800/500 SDR11 ISO S-5	800	500	485	302	800	45,4	227	58,7
900/63	25.289.9063.11	900/63 SDR11 ISO S-5	900	63	140	128	200	5,8	78	0,9
900/90	25.289.9090.11	900/90 SDR11 ISO S-5	900	90	156	144	200	8,2	94	1,0
900/110	25.289.9011.11	900/110 SDR11 ISO S-5	900	110	164	147	250	10	97	1,5
900/125	25.289.9012.11	900/125 SDR11 ISO S-5	900	125	175	152	280	11,4	102	2,1
900/160	25.289.9016.11	900/160 SDR11 ISO S-5	900	160	192	163	315	14,6	113	3,0
900/180	25.289.9018.11	900/180 SDR11 ISO S-5	900	180	209	175	355	16,4	120	4,1
900/200	25.289.9020.11	900/200 SDR11 ISO S-5	900	200	225	182	400	18,2	127	5,5
900/225	25.289.9022.11	900/225 SDR11 ISO S-5	900	225	232	190	400	20,5	135	5,9

**Stutzenschelle**  
mechanisch gefertigt  
PE 100 schwarz

**Spigot Saddle**  
machined  
PE 100 black

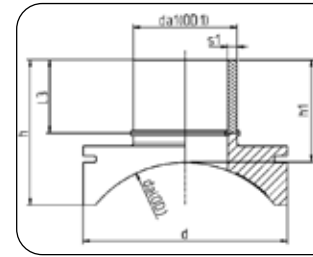
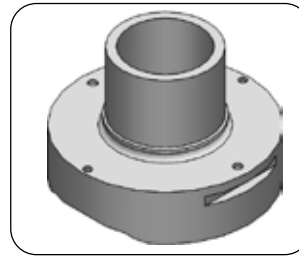

**Code 289**

Dimension	Code	Detail	da/OD [mm]	da1/OD1 [mm]	h [mm]	h1 [mm]	d [mm]	s1 [mm]	l3 [mm]	Gewicht/Weight [kg/m]
900/250	25.289.9025.11	900/250 SDR11 ISO S-5	900	250	254	199	450	22,7	144	7,9
900/280	25.289.9028.11	900/280 SDR11 ISO S-5	900	280	277	209	500	25,4	154	10,7
900/315	25.289.9031.11	900/315 SDR11 ISO S-5	900	315	305	225	560	28,6	165	15,8
900/355	25.289.9035.11	900/355 SDR11 ISO S-5	900	355	345	239	630	32,2	179	22,3
900/400	25.289.9040.11	900/400 SDR11 ISO S-5	900	400	361	259	630	36,3	194	25,2
900/450	25.289.9045.11	900/450 SDR11 ISO S-5	900	450	410	280	710	40,9	210	37,4
900/500	25.289.9050.11	900/500 SDR11 ISO S-5	900	500	468	302	800	45,4	227	55,3
1000/63	25.289.1063.11	1000/63 SDR11 ISO S-5	1000	63	139	128	200	5,8	78	0,9
1000/90	25.289.1090.11	1000/90 SDR11 ISO S-5	1000	90	155	144	200	8,2	94	1,0
1000/110	25.289.1011.11	1000/110 SDR11 ISO S-5	1000	110	163	147	250	10	97	1,5
1000/125	25.289.1012.11	1000/125 SDR11 ISO S-5	1000	125	172	152	280	11,4	102	2,1
1000/160	25.289.1016.11	1000/160 SDR11 ISO S-5	1000	160	189	163	315	14,6	113	2,9
1000/180	25.289.1018.11	1000/180 SDR11 ISO S-5	1000	180	206	175	355	16,4	120	4,0
1000/200	25.289.1020.11	1000/200 SDR11 ISO S-5	1000	200	221	182	400	18,2	127	5,3
1000/225	25.289.1022.11	1000/225 SDR11 ISO S-5	1000	225	228	190	400	20,5	135	5,7
1000/250	25.289.1025.11	1000/250 SDR11 ISO S-5	1000	250	249	199	450	22,7	144	7,7
1000/280	25.289.1028.11	1000/280 SDR11 ISO S-5	1000	280	270	209	500	25,4	154	10,4
1000/315	25.289.1031.11	1000/315 SDR11 ISO S-5	1000	315	298	225	560	28,6	165	15,2
1000/355	25.289.1035.11	1000/355 SDR11 ISO S-5	1000	355	335	239	630	32,2	179	21,4
1000/400	25.289.1040.11	1000/400 SDR11 ISO S-5	1000	400	352	259	630	36,3	194	24,3
1000/450	25.289.1045.11	1000/450 SDR11 ISO S-5	1000	450	398	280	710	40,9	210	35,8
1000/500	25.289.1050.11	1000/500 SDR11 ISO S-5	1000	500	453	302	800	45,4	227	52,7
1200/63	25.289.1263.11	1200/63 SDR11 ISO S-5	1200	63	137	128	200	5,8	78	0,9
1200/90	25.289.1290.11	1200/90 SDR11 ISO S-5	1200	90	153	144	200	8,2	94	0,9
1200/110	25.289.1211.11	1200/110 SDR11 ISO S-5	1200	110	161	147	250	10	97	1,5
1200/125	25.289.1212.11	1200/125 SDR11 ISO S-5	1200	125	169	152	280	11,4	102	2,0
1200/160	25.289.1216.11	1200/160 SDR11 ISO S-5	1200	160	184	163	315	14,6	113	2,8
1200/180	25.289.1218.11	1200/180 SDR11 ISO S-5	1200	180	201	175	355	16,4	120	3,8
1200/200	25.289.1220.11	1200/200 SDR11 ISO S-5	1200	200	215	182	400	18,2	127	5,1
1200/225	25.289.1222.11	1200/225 SDR11 ISO S-5	1200	225	222	190	400	20,5	135	5,5
1200/250	25.289.1225.11	1200/250 SDR11 ISO S-5	1200	250	241	199	450	22,7	144	7,4
1200/280	25.289.1228.11	1200/280 SDR11 ISO S-5	1200	280	261	209	500	25,4	154	9,9
1200/315	25.289.1231.11	1200/315 SDR11 ISO S-5	1200	315	286	225	560	28,6	165	14,4
1200/355	25.289.1235.11	1200/355 SDR11 ISO S-5	1200	355	320	239	630	32,2	179	20,0
1200/400	25.289.1240.11	1200/400 SDR11 ISO S-5	1200	400	337	259	630	36,3	194	22,9
1200/450	25.289.1245.11	1200/450 SDR11 ISO S-5	1200	450	380	280	710	40,9	210	33,6
1200/500	25.289.1250.11	1200/500 SDR11 ISO S-5	1200	500	430	302	800	45,4	227	49,0
1400/63	25.289.1463.11	1400/63 SDR11 ISO S-5	1400	63	136	128	200	5,8	78	0,8
1400/90	25.289.1490.11	1400/90 SDR11 ISO S-5	1400	90	152	144	200	8,2	94	0,9

**Stutzenschelle**  
mechanisch gefertigt  
PE 100 schwarz

**Spigot Saddle**  
machined  
PE 100 black

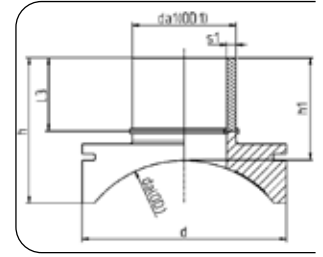
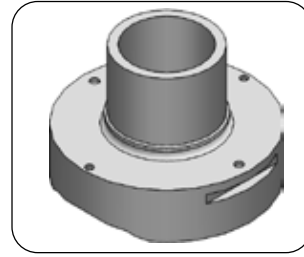

**Code 289**

Dimension	Code	Detail	da/OD [mm]	da1/OD1 [mm]	h [mm]	h1 [mm]	d [mm]	s1 [mm]	l3 [mm]	Gewicht/Weight [kg/m]
1400/110	25.289.1411.11	1400/110 SDR11 ISO S-5	1400	110	159	147	250	10	97	1,5
1400/125	25.289.1425.11	1400/125 SDR11 ISO S-5	1400	125	167	152	280	11,4	102	2,0
1400/160	25.289.1416.11	1400/160 SDR11 ISO S-5	1400	160	181	163	315	14,6	113	2,8
1400/180	25.289.1418.11	1400/180 SDR11 ISO S-5	1400	180	197	175	355	16,4	120	3,8
1400/200	25.289.1420.11	1400/200 SDR11 ISO S-5	1400	200	210	182	400	18,2	127	5,3
1400/225	25.289.1422.11	1400/225 SDR11 ISO S-5	1400	225	217	190	400	20,5	135	5,4
1400/250	25.289.1425.11	1400/250 SDR11 ISO S-5	1400	250	235	199	450	22,7	144	7,2
1400/280	25.289.1428.11	1400/280 SDR11 ISO S-5	1400	280	253	209	500	25,4	154	9,5
1400/315	25.289.1431.11	1400/315 SDR11 ISO S-5	1400	315	278	225	560	28,6	165	13,9
1400/355	25.289.1435.11	1400/355 SDR11 ISO S-5	1400	355	309	239	630	32,2	179	19,1
1400/400	25.289.1440.11	1400/400 SDR11 ISO S-5	1400	400	326	259	630	36,3	194	22,0
1400/450	25.289.1445.11	1400/450 SDR11 ISO S-5	1400	450	367	280	710	40,9	210	32,2
1400/500	25.289.1450.11	1400/500 SDR11 ISO S-5	1400	500	413	302	800	45,4	227	46,5
1600/315	25.289.1631.11	1600/315 SDR11 ISO S-5	1600	315	271	225	560	28,6	165	13,4
1600/355	25.289.1635.11	1600/355 SDR11 ISO S-5	1600	355	300	239	630	32,2	179	18,4
1600/400	25.289.1640.11	1600/400 SDR11 ISO S-5	1600	400	318	259	630	36,3	194	21,4
1600/450	25.289.1645.11	1600/450 SDR11 ISO S-5	1600	450	356	280	710	40,9	210	31,1
1600/500	25.289.1650.11	1600/500 SDR11 ISO S-5	1600	500	400	302	800	45,4	227	44,7
1600/630	25.289.1656.11	1600/630 SDR11 ISO S-5	1600	630	499	330	1000	50,8	270	93,7
1600/710	25.289.1671.11	1600/710 SDR11 ISO S-5	1600	710	545	365	1120	57,2	270	131,4
1800/315	25.289.1831.11	1800/315 SDR11 ISO S-5	1800	315	266	225	560	28,6	165	13,1
1800/355	25.289.1835.11	1800/355 SDR11 ISO S-5	1800	355	294	239	630	32,2	179	17,9
1800/400	25.289.1840.11	1800/400 SDR11 ISO S-5	1800	400	312	259	630	36,3	197	20,9
1800/450	25.289.1845.11	1800/450 SDR11 ISO S-5	1800	450	348	280	710	40,9	210	30,2
1800/500	25.289.1850.11	1800/500 SDR11 ISO S-5	1800	500	389	302	800	45,4	227	43,3
2000/315	25.289.2031.11	2000/315 SDR11 ISO S-5	2000	315	262	225	560	28,6	165	12,9
2000/355	25.289.2035.11	2000/355 SDR11 ISO S-5	2000	355	288	239	630	32,2	179	17,5
2000/400	25.289.2040.11	2000/400 SDR11 ISO S-5	2000	400	307	259	630	36,3	197	20,5
2000/450	25.289.2045.11	2000/450 SDR11 ISO S-5	2000	450	341	280	710	40,9	210	29,6
2000/500	25.289.2050.11	2000/500 SDR11 ISO S-5	2000	500	381	302	800	45,4	227	42,2
2250/315	25.289.2231.11	2250/315 SDR11 ISO S-5	2250	315	258	225	560	28,6	165	12,6
2250/355	25.289.2235.11	2250/355 SDR11 ISO S-5	2250	355	283	239	630	32,2	179	17,1
2250/400	25.289.2240.11	2250/400 SDR11 ISO S-5	2250	400	302	259	630	36,3	194	20,0
2250/450	25.289.2245.11	2250/450 SDR11 ISO S-5	2250	450	335	280	710	40,9	210	28,9
2250/500	25.289.2250.11	2250/500 SDR11 ISO S-5	2250	500	372	302	800	45,4	227	41,2
2300/315	25.289.2331.11	2300/500 SDR11 ISO S-5	2300	315	258	225	560	28,6	165	16,6
2300/355	25.289.2335.11	2300/560 SDR11 ISO S-5	2300	355	283	239	630	32,2	179	19,1
2300/400	25.289.2340.11	2300/630 SDR11 ISO S-5	2300	400	302	259	630	36,3	194	22,0
2300/450	25.289.2345.11	2300/710 SDR11 ISO S-5	2300	450	335	280	710	40,9	210	31,9

XXL Rohre  
XXL pipes

Formteile  
Fittings

Flansche & Zubehör  
Flanges & Accessories

Schweißtechnik  
Welding Technology

**Stutzenschelle**  
mechanisch gefertigt  
PE 100 schwarz

**Spigot Saddle**  
machined  
PE 100 black

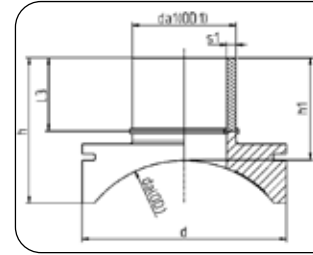
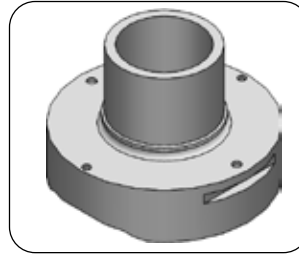

**Code 289**

Dimension	Code	Detail	da/OD [mm]	da1/OD1 [mm]	h [mm]	h1 [mm]	d [mm]	s1 [mm]	l3 [mm]	Gewicht/Weight [kg/m]
2300/500	25.289.2350.11	2300/800 SDR11 ISO S-5	2300	500	372	308	800	45,4	227	43,2
2500/315	25.289.2531.11	2500/315 SDR11 ISO S-5	2500	315	255	225	560	28,6	165	12,4
2500/355	25.289.2535.11	2500/355 SDR11 ISO S-5	2500	355	280	239	630	32,2	179	16,8
2500/400	25.289.2540.11	2500/400 SDR11 ISO S-5	2500	400	297	259	630	36,3	194	19,8
2500/450	25.289.2545.11	2500/450 SDR11 ISO S-5	2500	450	329	280	710	40,9	210	28,4
2500/500	25.289.2550.11	2500/500 SDR11 ISO S-5	2500	500	366	302	800	45,4	227	40,3

Größere Dimensionen auf Anfrage bis da 3500mm. Abzweigung Ø 1400 mm.  
Larger dimensions on request up to OD 3500 mm. Branch Ø 1400 mm.





**FLANSCH & ZUBEHÖR**  
**FLANGES & ACCESSORIES**

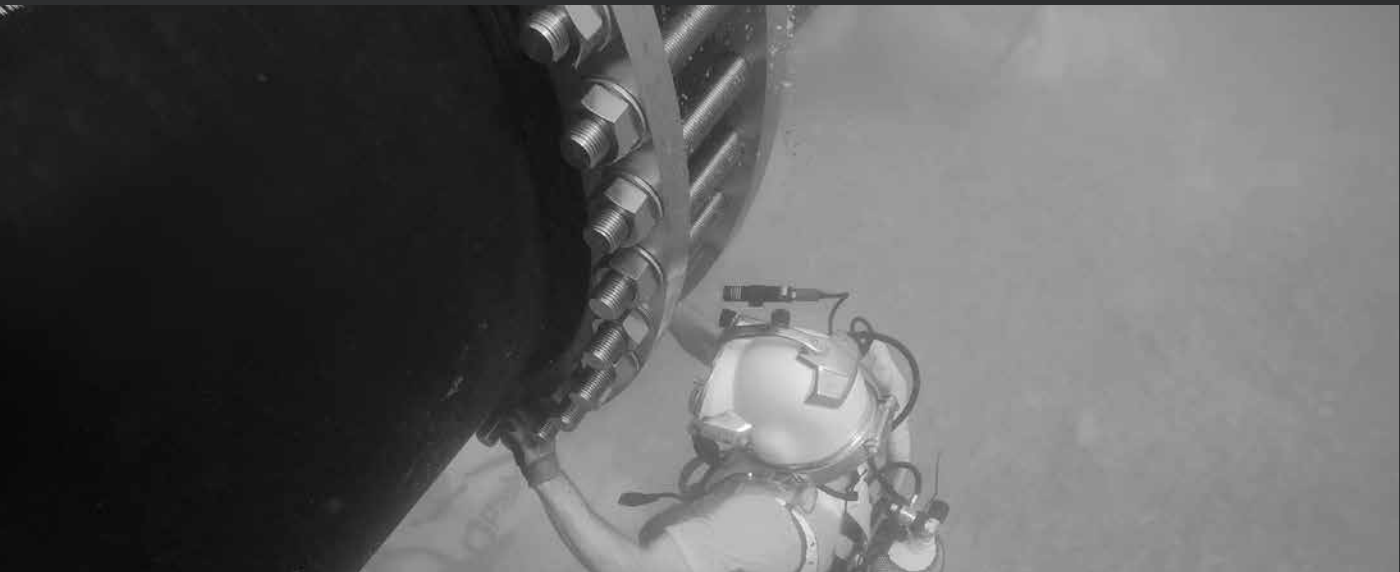



## LOSFLANSCHEN BACKING RINGS

Seite  
page

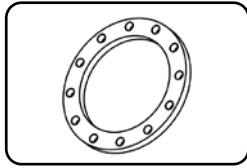

Code: 90.014

**Losflansch DIN**  
DIN PN 10

Stahl verzinkt

**Backing ring DIN**  
DIN PN 10

Steel hot-dip galvanized

185

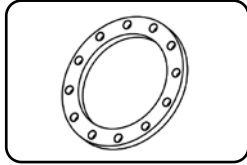

Code: 90.013

**Losflansch ANSI**  
AWWA C207-07, Class D

Stahl verzinkt

**Backing ring ANSI**  
AWWA C207-07, Class D

Steel hot-dip galvanized

186

## BLINDFLANSCHEN BLIND FLANGES

Seite  
page

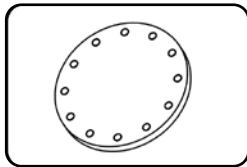

Code: 90.045

**Blindflansch DIN**  
DIN PN 10

Stahl verzinkt

**Blindflansch DIN**  
DIN PN 10

Steel hot-dip galvanized

187

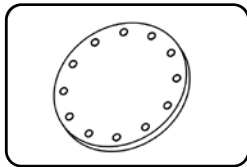

Code: 90.043

**Blindflansch ANSI**  
AWWA C207-07, Class D

Stahl verzinkt

**Blind flange ANSI**  
AWWA C207-07, Class D

Steel hot-dip galvanized

188

## DICHTUNGEN SEALS

Seite  
page

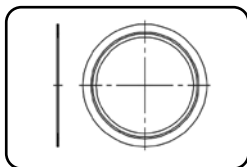

Code: 381.26H

**Dichtung DIN**  
DIN PN 6,3

EPDM + Stahleinleger

**Seal DIN**  
DIN PN 6,3

EPDM + steel insert

189

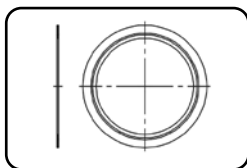

Code: 381.27H

**Dichtung ANSI**  
AWWA C207-07, Class B

EPDM + Stahleinleger

**Seal ANSI**  
AWWA C207-07, Class B

EPDM + steel insert

190

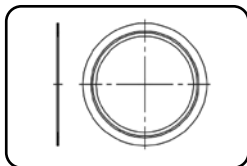

Code: 381.17H

**Dichtung DIN**  
DIN PN 10

EPDM + Stahleinleger

**Seal DIN**  
DIN PN 10

EPDM + steel insert

191

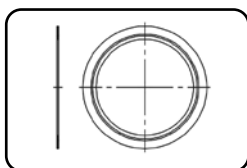

Code: 381.18H

**Dichtung ANSI**  
AWWA C207-07, Class D

EPDM + Stahleinleger

**Seal ANSI**  
AWWA C207-07, Class D

EPDM + steel insert

192

**SCHRAUBEN-SETS**  
**SCREW SETS**

**Seite**  
**page**

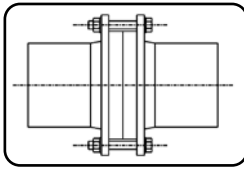

Code: 999.00H

**Schraubenset DIN**  
DIN PN 10  
Losflansch + Losflansch  
Stahl verzinkt

**Screw set DIN**  
DIN PN 10  
Backing ring + backing ring  
Steel hot-dip galvanized

193

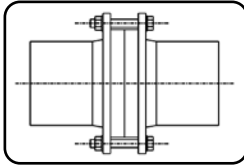

Code: 999.01H

**Schraubenset ANSI**  
AWWA C207-07, Class D  
Losflansch + Losflansch  
Stahl verzinkt

**Screw set ANSI**  
AWWA C207-07, Class D  
Backing ring + backing ring  
Steel hot-dip galvanized

194

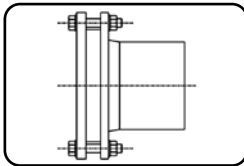

Code: 999.02H

**Schraubenset DIN**  
DIN PN 10  
Losflansch + Blindflansch  
Stahl verzinkt

**Screw set DIN**  
DIN PN 10  
Backing ring + blind flange  
Steel hot-dip galvanized

195

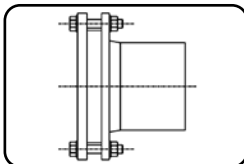

Code: 999.03H

**Schraubenset ANSI**  
AWWA C207-07, Class D  
Losflansch + Blindflansch  
Stahl verzinkt

**Screw set ANSI**  
AWWA C207-07, Class D  
Backing ring + blind flange  
Steel hot-dip galvanized

196

### Losflansch

Für Flanschverbindung  
DIN PN 10  
Stahl feuerverzinkt  
Gebohrt gem.  
DIN EN 1092-1

### Backing ring

For flange connection  
DIN PN 10  
Steel hot-dip galvanized  
Drilled acc.  
DIN EN 1092-1

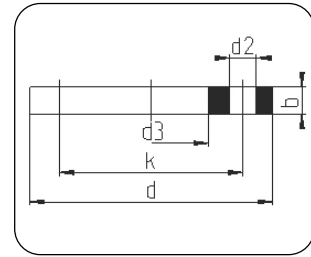
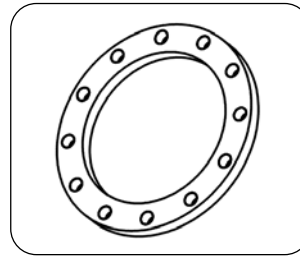

### Code 90.014

Dimension	Code	da (OD) [mm]	d [mm]	d2 [mm]	d3 [mm]	b [mm]	k [mm]	Nb	Größe Size [M]	Gewicht Weight kg/Stk.
800	90.014.0800.17	800	1015	33	845	56	950	24	M30	101,50
900	90.014.0900.17	900	1115	33	949	62	1050	28	M30	120,90
1000	90.014.1000.17	1000	1230	36	1052	70	1160	28	M33	161,70
1200	90.014.1200.17	1200	1455	39	1255	83	1380	32	M36	255,70
1400	90.014.1400.17	1400	1675	42	1435	90	1590	36	M39	383,80
1600	90.014.1600.17	1600	1915	48	1665	95	1820	40	M45	476,30
1800	90.014.1800.17	1800	2115	48	1875	100	2020	44	M45	534,70
2000	90.014.2000.17	2000	2325	48	2085	105	2230	48	M45	621,40
2250	90.014.2250.17	2250	2610	56	2335	110	2495	52	M52	822,10
2500	90.014.2500.17	2500	2960	56	2570	115	2804	60	M52	1.413,60
2720	90.014.2720.17	2720	3180	56	2820	124	3070	64	M52	1.517,00
2830	90.014.2830.17	2830	3285	62	2910	130	3170	68	M56	1.673,60
3000	90.014.3000.17	3000	3405	62	3110	130	3290	68	M56	1.347,90

Nb: Anzahl der Bohrungen / Nb: Number of bolt holes

Edelstahl auf Anfrage / Stainless steel on request

### Losflansch

Für ANSI Flansch-  
verbindung Class D  
Stahl feuerverzinkt  
Gemäß AWWA C207-07,  
Class D (175-150 psi)

### Backing ring

For ANSI flange  
connection Class D  
Steel hot-dip galvanized  
According to AWWA  
C207-07,  
Class D (175-150 psi)

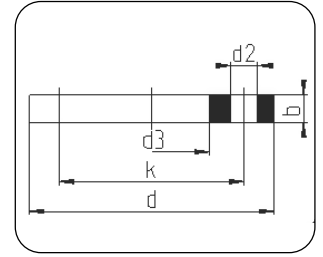
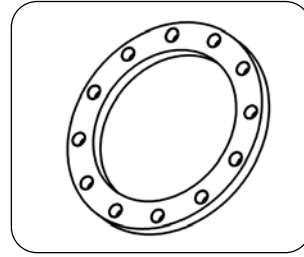

### Code 90.013

Dimension		Code	da (OD) [mm]	d [mm]	d2 [mm]	d3 [mm]	b [mm]	k [mm]	Nb	Größe Size ["]	Größe Size [M]	Gewicht Weight kg/Stk.
[mm]	[inch]											
800	32	90.013.0800.17	800	1060,0	41,3	845,0	38,1	977,9	28	1,5"	M39	86,10
900	36	90.013.0900.17	900	1170,0	41,3	949,0	41,3	1085,8	32	1,5"	M39	106,70
1000	40	90.013.1000.17	1000	1289,0	41,3	1052,0	41,3	1200,2	36	1,5"	M39	127,30
1200	48	90.013.1200.17	1200	1510,0	41,3	1255,0	47,6	1422,4	44	1,5"	M39	187,30
1400	54	90.013.1400.17	1400	1685,0	47,6	1460,0	53,9	1593,8	44	1,75"	M45	204,60
1600	66	90.013.1600.17	1600	2032,0	47,6	1665,0	63,5	1930,4	52	1,75"	M45	491,30
1800	72	90.013.1800.17	1800	2197,0	47,6	1875,0	66,7	2095,5	60	1,75"	M45	489,50
2000	78	90.013.2000.17	2000	2362,0	56,0	2085,0	69,9	2260,6	64	2,0"	M52	450,10
2250	90	90.013.2250.17	2250	2705,0	62,0	2370,0	76,2	2590,8	68	2,25"	M56	684,60
2500	102	90.013.2500.17	2500	3048,0	70,0	2560,0	82,6	2908,3	72	2,5"	M64	1.229,50
2720	108	90.013.2720.17	2720	3220,0	70,0	2820,0	85,7	3067,1	72	2,5"	M64	1.104,10
2830	114	90.013.2830.17	2830	3391,0	74,0	2910,0	88,9	3219,5	76	2,75"	M68	1.451,40
3000	120	90.013.3000.17	3000	3563,0	74,0	3100,0	88,9	3371,9	76	2,75"	M68	1.481,50
3260	132	90.013.3260.17	3260	3905,0	82,0	3360,0	98,5	3702,1	80	3,0"	M76	2.104,40

Nb: Anzahl der Bohrungen / Nb: Number of bolt holes

Edelstahl auf Anfrage / Stainless steel on request

Größere Dimensionen auf Anfrage bis da 3500mm. Abzweigung Ø 1400 mm.

Larger dimensions on request up to OD 3500 mm. Branch Ø 1400 mm.

**Blindflansch**

Für Flanschverbindung  
DIN PN 10  
Stahl feuerverzinkt  
Gebohrt gem. DIN EN  
1092-1

**Blind flange**

For flange connection  
DIN PN 10  
Steel hot-dip galvanized  
Drilled acc. DIN EN 1092-1

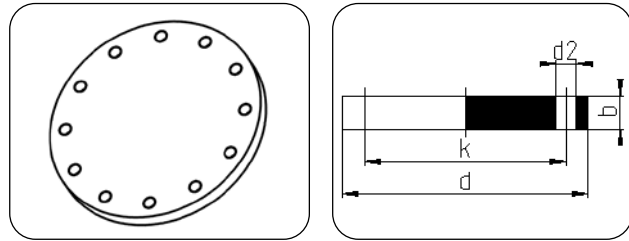

**Code 90.045**

Dimension	Code	da (OD) [mm]	d [mm]	d2 [mm]	b [mm]	k [mm]	Nb	Größe Size [M]	Gewicht Weight kg/Stk.
800	90.045.0800.17	800	1015	33	48	950	24	M30	301,00
900	90.045.0900.17	900	1115	33	50	1050	28	M30	378,70
1000	90.045.1000.17	1000	1230	36	54	1160	28	M33	497,90
1200	90.045.1200.17	1200	1455	39	66	1380	32	M36	852,40
1400	90.045.1400.17	1400	1675	42	77	1590	36	M39	1.318,40
1600	90.045.1600.17	1600	1915	48	88	1820	40	M45	1.964,40
1800	90.045.1800.17	1800	2115	48	100	2020	44	M45	2.729,80
2000	90.045.2000.17	2000	2325	48	110	2230	48	M45	3.636,80
2250	90.045.2250.17	2250	2610	56	124	2495	52	M52	5.148,00
2500	90.045.2500.17	2500	2960	56	138	2804	60	M52	7.387,40
2720	90.045.2720.17	2720	3180	56	150	3070	64	M52	9.283,20
2830	90.045.2830.17	2830	3285	62	165	3170	68	M56	10.848,40
3000	90.045.3000.17	3000	3405	62	165	3290	68	M56	11.675,50

Nb: Anzahl der Bohrungen / Nb: Number of bolt holes  
Edelstahl auf Anfrage / Stainless steel on request



**Blindflansch**

für ANSI Flansch-  
verbindung Class D  
Stahl feuerverzinkt  
Gemäß  
AWWA C207-07,  
Class D (175-150 psi)

**Blind flange**

for ANSI flange  
connection Class D  
Steel hot-dip galvanized  
According to  
AWWA C207-07,  
Class D (175-150 psi)

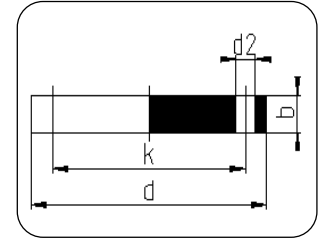
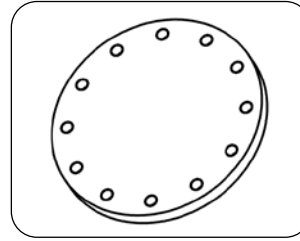

**Code 90.043**

Dimension		Code	da (OD) [mm]	d [mm]	d2 [mm]	b [mm]	k [mm]	Nb	Größe Size ["]	Größe Size [M]	Gewicht Weight kg/Stk.
[mm]	[inch]										
800	32	90.043.0800.17	800	1060,0	41,3	54,6	977,9	28	1,5"	M39	366,80
900	36	90.043.0900.17	900	1170,0	41,3	60,2	1085,8	32	1,5"	M39	494,10
1000	40	90.043.1000.17	1000	1289,0	41,3	66,3	1200,2	36	1,5"	M39	662,50
1200	48	90.043.1200.17	1200	1510,0	41,3	78,0	1422,4	44	1,5"	M39	1.074,40
1400	54	90.043.1400.17	1400	1685,0	47,6	87,2	1593,8	44	1,75"	M45	1.491,60
1600	66	90.043.1600.17	1600	2032,0	47,6	105,0	1930,4	52	1,75"	M45	2.629,80
1800	72	90.043.1800.17	1800	2197,0	47,6	113,8	2095,5	60	1,75"	M45	3.333,20
2000	78	90.043.2000.17	2000	2362,0	56,0	125,0	2260,6	64	2,0"	M52	4.197,80
2250	90	90.043.2250.17	2250	2705,0	62,0	145,0	2590,8	68	2,25"	M56	6.388,00
2500	102	90.043.2500.17	2500	3048,0	70,0	160,0	2908,3	72	2,5"	M64	8.928,90
2720	108	90.043.2720.17	2720	3220,0	70,0	170,0	3067,1	72	2,5"	M64	10.631,30
2830	114	90.043.2830.17	2830	3391,0	74,0	175,0	3219,5	76	2,75"	M68	12.110,00
3000	120	90.043.3000.17	3000	3563,0	74,0	180,0	3371,9	76	2,75"	M68	13.800,20
3260	132	90.043.3260.17	3260	3905,0	82,0	190,0	3702,1	80	3,0"	M76	17.452,50

Nb: Anzahl der Bohrungen / Nb: Number of bolt holes

Edelstahl auf Anfrage / Stainless steel on request

Größere Dimensionen auf Anfrage bis da 3500mm. Abzweigung Ø 1400 mm.

Larger dimensions on request up to OD 3500 mm. Branch Ø 1400 mm.

**DICHTUNG EPDM**  
**nach DIN PN 6,3**  
Edelstahleinleger  
umschlossen  
Härte 60 - 70 Shore

**GASKET EPDM**  
**for DIN PN 6,3**  
Stainless steel  
insert enclosed  
Hardness 60 - 70 Shore

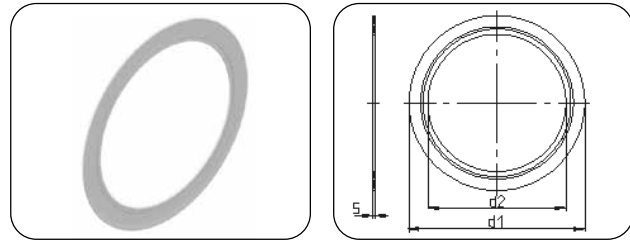

**Code 88.381**

Dimension	Code	Detail	d1 (OD) [mm]	d2 (ID) [mm]	s [mm]	Shore A	Gewicht Weight kg/Stk.
800	88.381.0800.26H	800X6,0 SDR26 ISO S-12,5	905	739	6	60 - 70	6,7
900	88.381.0900.26H	900X6,0 SDR26 ISO S-12,5	1005	832	6	60 - 70	7,8
1000	88.381.1000.26H	1000x6,0 SDR26 ISO S-12,5	1110	924	6	60 - 70	9,3
1200	88.381.1200.26H	1200X6,0 SDR26 ISO S-12,5	1330	1109	6	60 - 70	13,3
1400	88.381.1400.26H	1400X9,0 SDR26 ISO S-12,5	1535	1293	9	60 - 70	16,9
1600	88.381.1600.26H	1600X9,0 SDR26 ISO S-12,5	1760	1478	9	60 - 70	28,1
1800	88.381.1800.26H	1800X9,0 SDR26 ISO S-12,5	1960	1663	9	60 - 70	33,2
2000	88.381.2000.26H	2000X9,0 SDR26 ISO S-12,5	2170	1848	9	60 - 70	39,9
2250	88.381.2250.26H	2250X9,0 SDR26 ISO S-12,5	2435	2078	9	60 - 70	49,6
2500	88.381.2500.26H	2500X11,0 SDR26 ISO S-12,5	2730	2308	11	60 - 70	65,5
2720	88.381.2720.26H	2720X11,0 SDR26 ISO S-12,5	2990	2512	11	60 - 70	81,0
2830	88.381.2830.26H	2830X11,0 SDR26 ISO S-12,5	3080	2614	11	60 - 70	82,0
3000	88.381.3000.26H	3000X11,0 SDR26 ISO S-12,5	3220	2770	11	60 - 70	83,1

**DICHTUNG EPDM  
nach ANSI**  
AWWA C207-07,  
Class B (86 psi)  
Edelstahleinleger  
umschlossen  
Härte 60 - 70 Shore

**GASKET EPDM  
for ANSI**  
AWWA C207-07,  
Class B (86 psi)  
Stainless steel  
insert enclosed  
Hardness 60 - 70 Shore

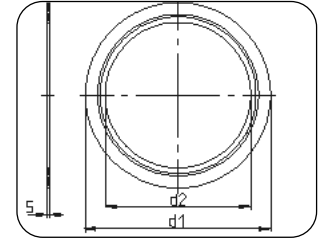
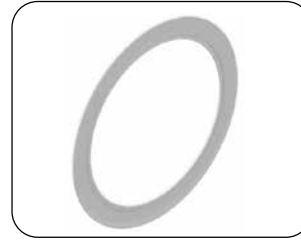

**Code 88.381**

Dimension		Code	Detail	d1 (OD) [mm]	d2 (ID) [mm]	s [mm]	Shore A	Gewicht Weight kg/Stk.
[mm]	[inch]							
800	32	88.381.0800.27H	800X6,0 SDR26 ISO S-12,5	930	739	6	60 - 70	7,9
900	36	88.381.0900.27H	900X6,0 SDR26 ISO S-12,5	1040	832	6	60 - 70	9,6
1000	40	88.381.1000.27H	1000x6,0 SDR26 ISO S-12,5	1150	924	6	60 - 70	11,6
1200	48	88.381.1200.27H	1200X6,0 SDR26 ISO S-12,5	1375	1109	6	60 - 70	16,3
1400	54	88.381.1400.27H	1400X9,0 SDR26 ISO S-12,5	1540	1293	9	60 - 70	17,2
1600	66	88.381.1600.27H	1600X9,0 SDR26 ISO S-12,5	1875	1478	9	60 - 70	41,6
1800	72	88.381.1800.27H	1800X9,0 SDR26 ISO S-12,5	2040	1663	9	60 - 70	43,0
2000	78	88.381.2000.27H	2000X9,0 SDR26 ISO S-12,5	2195	1848	9	60 - 70	43,2
2250	90	88.381.2250.27H	2250X9,0 SDR26 ISO S-12,5	2520	2078	9	60 - 70	62,6
2500	96	88.381.2500.27H	2500X11,0 SDR26 ISO S-12,5	2830	2308	11	60 - 70	99,0
2720	108	88.381.2720.27H	2720X11,0 SDR26 ISO S-12,5	2970	2512	11	60 - 70	111,0
2830	114	88.381.2830.27H	2830X11,0 SDR26 ISO S-12,5	3130	2614	11	60 - 70	131,5
3000	120	88.381.3000.27H	3000X11,0 SDR26 ISO S-12,5	3270	2770	11	60 - 70	152,1
3260	132	88.381.3260.27H	3260X11,0 SDR26 ISO S-12,5	3600	3002	11	60 - 70	183,7

Größere Dimensionen auf Anfrage bis da 3500mm. Abzweigung Ø 1400 mm.  
Larger dimensions on request up to OD 3500 mm. Branch Ø 1400 mm.wv

**DICHTUNG EPDM**  
**nach DIN PN 10**  
Edelstahleinleger  
umschlossen  
Härte 60 - 70 Shore

**GASKET EPDM**  
**for DIN PN 10**  
Stainless steel  
insert enclosed  
Hardness 60 - 70 Shore

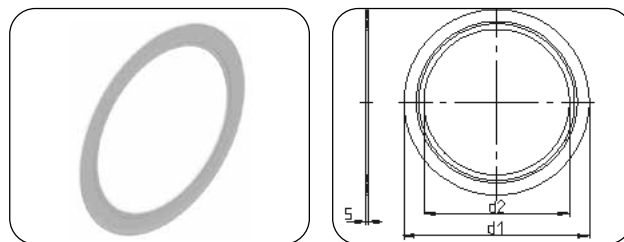

**Code 88.381**

Dimension	Code	Detail	d1 (OD) [mm]	d2 (ID) [mm]	s [mm]	Shore A	Gewicht Weight kg/Stk.
800	88.381.0800.17H	800X6,0 SDR17 ISO S-8	905	706	6	60 - 70	7,3
900	88.381.0900.17H	900X6,0 SDR17 ISO S-8	1005	794	6	60 - 70	8,6
1000	88.381.1000.17H	1000X6,0 SDR17 ISO S-8	1110	882	6	60 - 70	10,3
1200	88.381.1200.17H	1200X6,0 SDR17 ISO S-8	1330	1058	6	60 - 70	14,7
1400	88.381.1400.17H	1400X9,0 SDR17 ISO S-8	1535	1235	9	60 - 70	18,7
1600	88.381.1600.17H	1600X9,0 SDR17 ISO S-8	1760	1411	9	60 - 70	31,2
1800	88.381.1800.17H	1800X9,0 SDR17 ISO S-8	1960	1587	9	60 - 70	37,0
2000	88.381.2000.17H	2000X9,0 SDR17 ISO S-8	2170	1764	9	60 - 70	44,7
2250	88.381.2250.17H	2250X9,0 SDR17 ISO S-8	2435	1984	9	60 - 70	55,7
2500	88.381.2500.17H	2500X11,0 SDR17 ISO S-8	2730	2204	11	60 - 70	80,1
2720	88.381.2720.17H	2720X11,0 SDR17 ISO S-8	2990	2398	11	60 - 70	112,1
2830	88.381.2830.17H	2830X11,0 SDR17 ISO S-8	3080	2495	11	60 - 70	134,5
3000	88.381.3000.17H	3000X11,0 SDR17 ISO S-8	3220	2645	11	60 - 70	156,9

**DICHTUNG EPDM  
nach ANSI**  
AWWA C207-07,  
Class D (175-150 psi)  
Edelstahleinleger  
umschlossen  
Härte 60 - 70 Shore

**GASKET EPDM  
for ANSI**  
AWWA C207-07,  
Class D (175-150 psi)  
Stainless steel  
insert enclosed  
Hardness 60 - 70 Shore

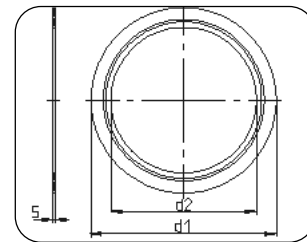
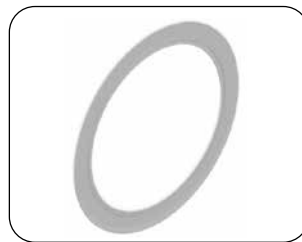

**Code 88.381**

Dimension		Code	Detail	d1 (OD) [mm]	d2 (ID) [mm]	s [mm]	Shore A	Gewicht Weight kg/Stk.
[mm]	[inch]							
800	32	88.381.0800.18H	800X6,0 SDR17 ISO S-8	930	706	6	60 - 70	7,9
900	36	88.381.0900.18H	900X6,0 SDR17 ISO S-8	1040	794	6	60 - 70	9,4
1000	40	88.381.1000.18H	1000X6,0 SDR17 ISO S-8	1150	882	6	60 - 70	11,2
1200	48	88.381.1200.18H	1200X6,0 SDR17 ISO S-8	1375	1058	6	60 - 70	16,0
1400	54	88.381.1400.18H	1400X9,0 SDR17 ISO S-8	1540	1235	9	60 - 70	20,5
1600	66	88.381.1600.18H	1600X9,0 SDR17 ISO S-8	1875	1411	9	60 - 70	27,3
1800	72	88.381.1800.18H	1800X9,0 SDR17 ISO S-8	2040	1587	9	60 - 70	40,8
2000	78	88.381.2000.18H	2000X9,0 SDR17 ISO S-8	2195	1764	9	60 - 70	49,3
2250	90	88.381.2250.18H	2250X9,0 SDR17 ISO S-8	2520	1984	9	60 - 70	61,4
2500	96	88.381.2500.18H	2500X11,0 SDR17 ISO S-8	2830	2204	11	60 - 70	77,5
2720	108	88.381.2720.18H	2720X11,0 SDR17 ISO S-8	2970	2398	11	60 - 70	94,9
2830	114	88.381.2830.18H	2830X11,0 SDR17 ISO S-8	3130	2494	11	60 - 70	105,5
3000	120	88.381.3000.18H	3000X11,0 SDR17 ISO S-8	3270	2645	11	60 - 70	116,2

**Schraubenset  
für Verbindung**

Losflansch /  
Losflansch DIN PN 10  
Stahl feuerverzinkt

**SET bestehend aus:**

1 Stk. Gewindebolzen,  
2 Stk. Muttern,  
2 Stk. Scheiben

**Screws-set  
for connection**

Backing ring /  
backing ring DIN PN 10  
Steel hot-dip galvanized

**SET consists of:**

1 pc. bolt,  
2 pcs. nuts,  
2 pcs. washers

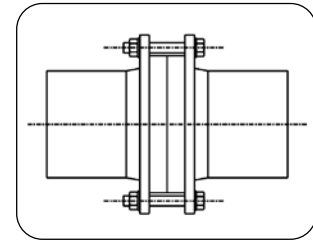
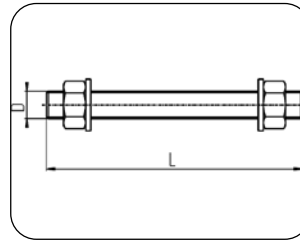

Code 90.999

Dimension	Code	da (OD) [mm]	D		L [mm]	Nb	Gewicht Weight kg/Set
			[mm]	[inch]			
800	90.999.0800.00H	800	M 30	1,125	350	24	2,18
900	90.999.0900.00H	900	M 30	1,125	370	28	2,27
1000	90.999.1000.00H	1000	M 33	1,250	400	28	3,05
1200	90.999.1200.00H	1200	M 36	1,375	460	32	4,18
1400	90.999.1400.00H	1400	M 39	1,500	500	36	5,40
1600	90.999.1600.00H	1600	M 45	1,750	550	40	8,32
1800	90.999.1800.00H	1800	M 45	1,750	590	44	8,76
2000	90.999.2000.00H	2000	M 45	1,750	630	48	9,20
2250	90.999.2250.00H	2250	M 52	2,000	690	52	13,30
2500	90.999.2500.00H	2500	M 52	2,000	730	60	13,88
2720	90.999.2720.00H	2720	M 52	2,000	780	64	14,61
2830	90.999.2830.00H	2830	M 56	2,250	800	68	19,28
3000	90.999.3000.00H	3000	M 56	2,250	840	68	20,24

Nb: Anzahl der Bohrungen / Nb: Number of bolt holes  
Edelstahl auf Anfrage / Stainless steel on request

**Schraubenset  
für Verbindung**

Losflansch / Losflansch,  
ANSI AWWA C207-07,  
Class D (175-150 psi)  
Stahl feuerverzinkt

**SET bestehend aus:**

1 Stk. Gewindebolzen,  
2 Stk. Muttern,  
2 Stk. Scheiben

**Screws-set  
for connection**

Backing ring / backing ring,  
ANSI AWWA C207-07,  
Class D (175-150 psi)  
Steel hot-dip galvanized

**SET consists of:**

1 pc. bolt,  
2 pcs. nuts,  
2 pcs. washers

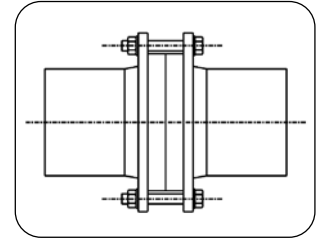
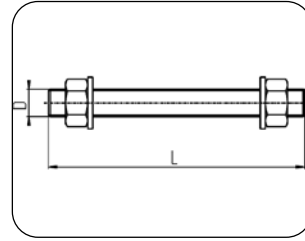

**Code 90.999**

Dimension		Code	da (OD) [mm]	D		L [mm]	Nb	Gewicht Weight kg/Set
[mm]	[inch]			[mm]	[inch]			
800	32	90.999.0800.01H	800	M 39	1,500	330	28	4,05
900	36	90.999.0900.01H	900	M 39	1,500	350	32	4,21
1000	40	90.999.1000.01H	1000	M 39	1,500	360	36	4,29
1200	48	90.999.1200.01H	1200	M 39	1,500	400	44	4,61
1400	54	90.999.1400.01H	1400	M 45	1,750	450	44	7,22
1600	66	90.999.1600.01H	1600	M 45	1,750	490	52	7,66
1800	72	90.999.1800.01H	1800	M 45	1,750	520	60	7,99
2000	78	90.999.2000.01H	2000	M 52	2,000	570	64	11,55
2250	90	90.999.2250.01H	2250	M 56	2,250	630	68	16,34
2500	96	90.999.2500.01H	2500	M 64	2,500	660	72	21,40
2720	108	90.999.2720.01H	2720	M 64	2,500	730	72	23,02
2830	114	90.999.2830.01H	2830	M 68	2,750	760	76	29,14
3000	120	90.999.3000.01H	3000	M 68	2,750	780	76	29,91
3260	132	90.999.3260.01H	3260	M 76	3,000	860	80	41,87

Nb: Anzahl der Bohrungen / Nb: Number of bolt holes  
Edelstahl auf Anfrage / Stainless steel on request

**Schraubenset  
für Verbindung**

Losflansch / Blindflansch  
DIN PN 10,  
ANSI AWWA C207-07,  
Class D (175-150 psi)  
Stahl feuerverzinkt

**SET bestehend aus:**

1 Stk. Gewindebolzen,  
2 Stk. Muttern,  
2 Stk. Scheiben

**Screws-set  
for connection**

Backing ring / blind flange,  
DIN PN 10,  
ANSI AWWA C207-07,  
Class D (175-150 psi)  
Steel hot-dip galvanized

**SET consists of:**

1 pc. bolt,  
2 pcs. nuts,  
2 pcs. washers

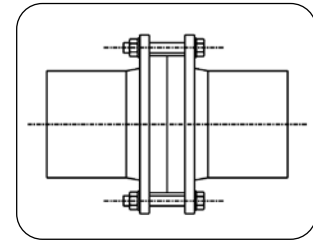
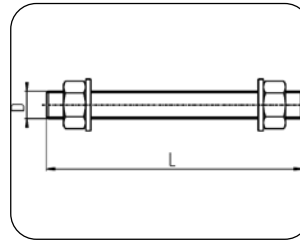

**Code 90.999**

Dimension	Code	da (OD) [mm]	D		L [mm]	Nb	Gewicht Weight kg/Set
			[mm]	[inch]			
800	90.999.0800.02H	800	M 30	1,125	270	24	1,84
900	90.999.0900.02H	900	M 30	1,125	290	28	1,93
1000	90.999.1000.02H	1000	M 33	1,250	310	28	2,57
1200	90.999.1200.02H	1200	M 36	1,375	360	32	3,52
1400	90.999.1400.02H	1400	M 39	1,500	390	36	4,53
1600	90.999.1600.02H	1600	M 45	1,750	430	40	7,00
1800	90.999.1800.02H	1800	M 45	1,750	460	44	7,33
2000	90.999.2000.02H	2000	M 45	1,750	490	48	7,66
2250	90.999.2250.02H	2250	M 52	2,000	550	52	11,26
2500	90.999.2500.02H	2500	M 52	2,000	580	60	11,70
2720	90.999.2720.02H	2720	M 52	2,000	620	64	12,28
2830	90.999.2830.02H	2830	M 56	2,250	640	68	16,32
3000	90.999.3000.02H	3000	M 56	2,250	670	68	17,08

Nb: Anzahl der Bohrungen / Nb: Number of bolt holes  
Edelstahl auf Anfrage / Stainless steel on request



**Schraubenset  
für Verbindung**

Losflansch / Blindflansch,  
ANSI AWWA C207-07,  
Class D (175-150 psi)  
Stahl feuerverzinkt

**SET bestehend aus:**

- 1 Stk. Gewindebolzen,
- 2 Stk. Muttern,
- 2 Stk. Scheiben

**Screws-set  
for connection**

Backing ring / blind flange,  
ANSI AWWA C207-07,  
Class D (175-150 psi)  
Steel hot-dip galvanized

**SET consists of:**

- 1 pc. bolt,
- 2 pcs. nuts,
- 2 pcs. washers

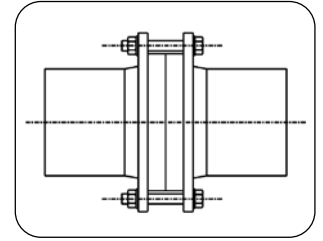
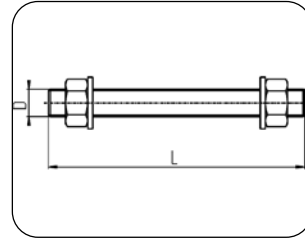

**Code 90.999**

Dimension		Code	da (OD) [mm]	D		L [mm]	Nb	Gewicht Weight kg/Set
[mm]	[inch]			[mm]	[inch]			
800	32	90.999.0800.03H	800	M 39	1,500	280	28	3,65
900	36	90.999.0900.03H	900	M 39	1,500	290	32	5,32
1000	40	90.999.1000.03H	1000	M 39	1,500	310	36	3,89
1200	48	90.999.1200.03H	1200	M 39	1,500	340	44	4,13
1400	54	90.999.1400.03H	1400	M 45	1,750	380	44	6,45
1600	66	90.999.1600.03H	1600	M 45	1,750	420	52	6,89
1800	72	90.999.1800.03H	1800	M 45	1,750	450	60	7,22
2000	78	90.999.2000.03H	2000	M 52	2,000	490	64	10,38
2250	90	90.999.2250.03H	2250	M 56	2,250	550	68	11,26
2500	96	90.999.2500.03H	2500	M 64	2,500	570	72	19,31
2720	108	90.999.2720.03H	2720	M 64	2,500	620	72	20,47
2830	114	90.999.2830.03H	2830	M 68	2,750	650	76	26,12
3000	120	90.999.3000.03H	3000	M 68	2,750	660	76	26,52
3260	132	90.999.3260.03H	3260	M 76	3,000	730	80	35,80

Nb: Anzahl der Bohrungen / Nb: Number of bolt holes  
Edelstahl auf Anfrage / Stainless steel on request

**SCHWEISSTECHNIK**  
**WELDING TECHNOLOGY**





**STUMPFSCHEISSMASCHINEN  
WELDING MACHINES**

**Seite  
page**

	Code: SWIDOSMINIP <b>Miniplast 2 (WIDOS)</b> einsetzbar da 20 - da 110	<b>Miniplast 2 (WIDOS)</b> used OD 20 - OD 110	200
	Code: SWIDOS4600 <b>WIDOS4600</b> einsetzbar da 90 - da 250	<b>WIDOS4600</b> used OD 90 - OD 250	200
	Code: SWIDOS4900 <b>WIDOS4900</b> einsetzbar da 90 - da 315	<b>WIDOS4900</b> used OD 90 - OD 315	200
	Code: SWIDOSMINIP <b>WIDOS 5100</b> einsetzbar da 200 - da 450	<b>WIDOS 5100</b> used OD 200 - OD 450	201
	Code: SWIDOS6100 <b>WIDOS 6100</b> einsetzbar da 355 - da 630	<b>WIDOS 6100</b> used OD 355 - OD 630	201
	Code: SWIDOS10000 <b>WIDOS 10000</b> einsetzbar da 560 - da 1000	<b>WIDOS 10000</b> used OD 560 - OD 1000	201
	Code: SWIDOS16000 <b>WIDOS 16000</b> einsetzbar da 1000 - da 1600	<b>WIDOS 16000</b> einsetzbar da 1000 - da 1600	202
	Code: SWIDOS20000 <b>WIDOS 20000</b> einsetzbar da 1400 - da 2000	<b>WIDOS 20000</b> used OD 1400 - OD 2250	202
	Code: SWIDOS2600 <b>WIDOS 26000</b> einsetzbar da 1400 - da 2500	<b>WIDOS 26000</b> used OD 1400 - OD 2500	202

XXL Rohre  
XXL pipes

Formteile  
Fittings

Flansche & Zubehör  
Flanges & Accessories

Schweißtechnik  
Welding Technology

**Miniplast 2 (WIDOS)**  
einsetzbar  $d_a 20 - d_a 110$

**Miniplast 2 (WIDOS)**  
used OD 20 - OD 110

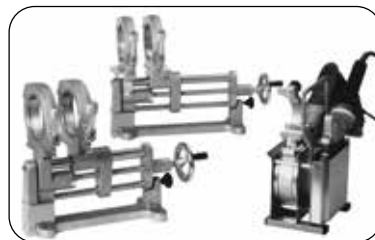

**Code SWIDOSMINIP**

Code	Detail	Mietpreis Gewicht Rental rate	Gewicht Weight
SWIDOSMINIP	Miniplast 2	auf Anfrage / on request	

**WIDOS4600**  
einsetzbar  $d_a 90 - d_a 250$

**WIDOS4600**  
used OD 90 - OD 250

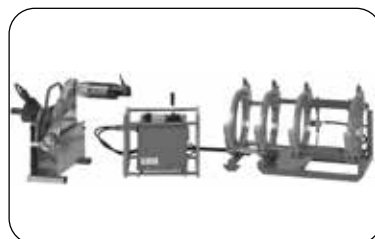

**Code SWIDOS4600**

Code	Detail	Mietpreis Gewicht Rental rate	Gewicht Weight
SWIDOS4600	Type 4600	auf Anfrage / on request	

**WIDOS4900**  
einsetzbar  $d_a 90 - d_a 315$

**WIDOS4900**  
used OD 90 - OD 315

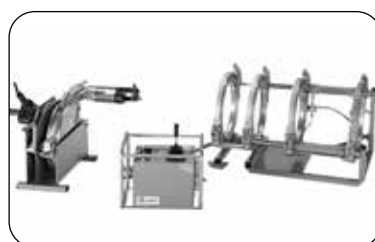

**Code SWIDOS4900**

Code	Detail	Mietpreis Gewicht Rental rate	Gewicht Weight
SWIDOS4900	Type 4900	auf Anfrage / on request	

**WIDOS 5100**

einsetzbar  $d_a$  200 -  $d_a$  450

**WIDOS 5100**

used OD 200 - OD 450

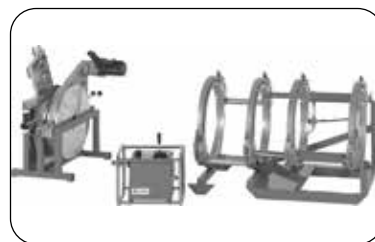

Code SWIDOSMINIP

Code	Detail	Mietpreis Gewicht Rental rate	Gewicht Weight
SWIDOSMINIP	Type 5100	auf Anfrage / on request	

**WIDOS 6100**

einsetzbar  $d_a$  355 -  $d_a$  630

**WIDOS 6100**

used OD 355 - OD 630



Code SWIDOS6100

Code	Detail	Mietpreis Gewicht Rental rate	Gewicht Weight
SWIDOS6100	Type 6100	auf Anfrage / on request	

**WIDOS 10000**

einsetzbar  $d_a$  560 -  $d_a$  1000

**WIDOS 10000**

used OD 560 - OD 1000



Code SWIDOS10000

Code	Detail	Mietpreis Gewicht Rental rate	Gewicht Weight
SWIDOS10000	Type 10 000	auf Anfrage / on request	

**WIDOS 16000**

einsetzbar  $d_a$  1000 -  $d_a$  1600

**WIDOS 16000**

used OD 1000 - OD 1600

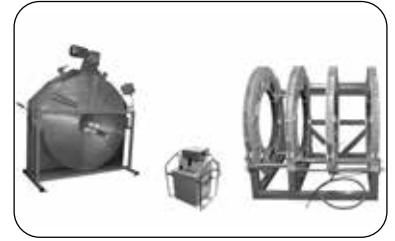

Code SWIDOS16000

Code	Detail	Mietpreis Gewicht Rental rate	Gewicht Weight
SWIDOS16000	Type 16 000	auf Anfrage / on request	

**WIDOS 20000**

einsetzbar  $d_a$  1400 -  $d_a$  2000

**WIDOS 20000**

used OD 1400 - OD 2250

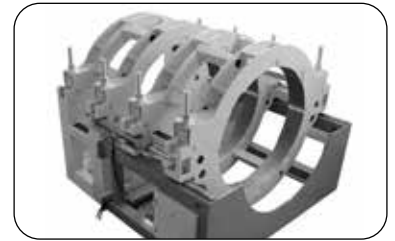

Code SWIDOS20000

Code	Detail	Mietpreis Gewicht Rental rate	Gewicht Weight
SWIDOS20000	Type 20 000	auf Anfrage / on request	

**WIDOS 26000**

einsetzbar  $d_a$  1400 -  $d_a$  2500

**WIDOS 26000**

used OD 1400 - OD 2500



Code SWIDOS26000

Code	Detail	Mietpreis Gewicht Rental rate	Gewicht Weight
SWIDOS26000	Type 26 000	auf Anfrage / on request	







## Piping Systems

AGRULINE | INDUSTRIE | PURAD



## Semi-Finished Products

SHEETS | ROUND BARS | RODS



## Concrete Protection

SURE GRIP | ULTRA GRIP | HYDRO<sup>CLICK</sup> | HYDRO<sup>+</sup>



## Lining Systems

GEOMEMBRANES | AGRUFLEX - TUNNEL LINER

0520

Ihr Fachhändler / Your distributor:



Satzfehler, Druckfehler und Änderungen vorbehalten.  
Abbildungen sind teilweise Symbolfotos.

Subject to errors of typesetting, misprints and modifications.  
Illustrations are generic and for reference only.

AGRU Kunststofftechnik GmbH  
Ing.-Pesendorfer-Straße 31  
4540 Bad Hall, Austria

T. +43 7258 7900  
F. +43 7258 790 - 2850  
office@agru.at



[www.agru.at](http://www.agru.at)