

<p>PP Betonschutzplatten <i>PP Concrete Protective Liners</i></p>	<p>3 - 8</p>
<p>PE Betonschutzplatten <i>PE Concrete Protective Liners</i></p>	<p>9 - 22</p>
<p>PE 80 / PEHD blau Hydro+ und Hydroclick <i>PE 80 / HDPE blue Hydro+ and Hydroclick</i></p>	<p>23 - 30</p>
<p>PEHD Bionic SCS Betonschutzplatten <i>HDPE Bionic SCS Concrete Protective Liners</i></p>	<p>31 - 36</p>
<p>PE 100-el ESD Betonschutzplatten <i>PE 100-el ESD Concrete Protective Liners</i></p>	<p>37 - 42</p>
<p>PVDF-FLEX Betonschutzplatten <i>PVDF-FLEX Concrete Protective Liners</i></p>	<p>43 - 48</p>
<p>ECTFE Betonschutzplatten <i>ECTFE Concrete Protective Liners</i></p>	<p>49 - 54</p>
<p>INDUKTOFIX <i>INDUKTOFIX</i></p>	<p>55 - 62</p>
<p>Schweissdraht <i>Welding-Rod</i></p>	<p>63 - 70</p>

BETONSCHUTZPLATTEN
PP CONCRETE
PROTECTIVE LINERS

PE BETONSCHUTZPLATTEN
PE CONCRETE
PROTECTIVE LINERS

PEHD BLAU HYDRO+
UND HYDROCLICK
PE 80 / HDPE BLUE HYDRO+
AND HYDROCLICK

PEHD BIONIC SCS BETONSCHUTZPLATTEN
HDPE BIONIC SCS CONCRETE PROTECTIVE LINERS

PE 100-EL ESD
BETONSCHUTZPLATTEN
PE 100-EL ESD CONCRETE
PROTECTIVE LINERS

PE 100-EL ESD
BETONSCHUTZPLATTEN
PE 100-EL ESD CONCRETE
PROTECTIVE LINERS

PVDF-FLEX BETONSCHUTZPLATTEN
PVDF-FLEX CONCRETE
PROTECTIVE LINERS

ECTFE BETONSCHUTZPLATTEN
ECTFE CONCRETE
PROTECTIVE LINERS

INDUKTOFIX
INDUKTOFIX

SCHWEISSDRAHT
WELDING-ROD

SCHWEISSDRAHT
WELDING-ROD

INDUKTOFIX
INDUKTOFIX

ECTFE BETONSCHUTZPLATTE
N
ECTFE CONCRETE
PROTECTIVE LINERS

PVDF-FLEX BETONSCHUTZPL
ATTEN
PVDF-FLEX CONCRETE
PROTECTIVE LINERS

PE 100-EL ESD
BETONSCHUTZPLATTEN
PE 100-EL ESD CONCRETE
PROTECTIVE LINERS

PEHD BIONIC SCS BETONSCH
UTZPLATTEN
HDPE BIONIC SCS CONCRETE
PROTECTIVE LINERS

PEHD BLAU HYDRO+
UND HYDROCLICK
PE 80 / HDPE BLUE HYDRO+
AND HYDROCLICK

PE BETONSCHUTZPLATTEN
PE CONCRETE
PROTECTIVE LINERS

PP BETONSCHUTZPLATTEN
PP CONCRETE
PROTECTIVE LINERS



PP BETONSCHUTZPLATTEN
PP CONCRETE PROTECTIVE LINERS

BETONSCHUTZPLATTEN
CONCRETE PROTECTIVE LINERS

Seite
page

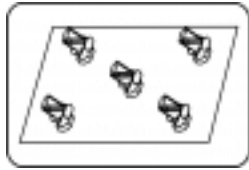

Code: 562
AGRU-Ultra Grip BSP
Noppen 13mm - 4000X2000mm
extrudiert
PPR grau

AGRU-Ultra Grip CPL
studs 13mm - 4000X2000mm
extruded
PPR grey

7

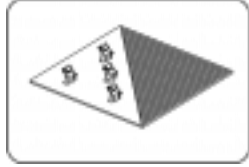

Code: 563
AGRU-Ultra Grip BSP
kaschiert Polyestergewebe
extrudiert
PPR grau

AGRU-Ultra Grip CPL
Polyester Fabric backed
extruded
PPR grey

7

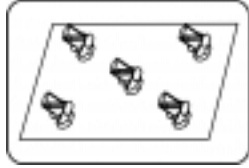

Code: 562
AGRU-Ultra Grip BSP
Noppen 13mm - 4000X2000mm
extrudiert
PPB schwarz

AGRU-Ultra Grip CPL
studs 13mm - 4000X2000mm
extruded
PPB black

7

PROFILE, BETONANKER
PROFILES, CONCRETE ANCHORS

Seite
page

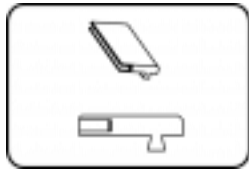

Code: 575
Abschluss-Profil
für Betonschutzplatte

PPB schwarz

End Profile
for concrete protective liner

PPB black

8

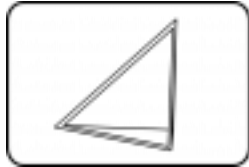

Code: 040
Ecken
für Betonschutzplatte
formgespritzt
PPR grau

Corner
for concrete protective liner
injection moulded
PPR grey

8

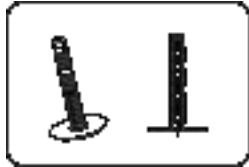

Code: 582
Betonanker
Befestigungsmittel
formgespritzt
PPR grau

Concrete anchor
Mounting accessory
injection moulded
PPR grey

8

PP BETONSCHUTZPLATTE
N
PP CONCRETE
PROTECTIVE LINERS

PE BETONSCHUTZPLATTEN
PE CONCRETE
PROTECTIVE LINERS

PEHD BLAU HYDRO+
UND HYDROCLICK
HDPE BLAU HYDRO+
UND HYDROCLICK

PEHD BIONIC SCS BETONSCHUTZPLATTEN
UTZPLATTEN
HDPE BIONIC SCS CONCRETE
PROTECTIVE LINERS

PE 100-EL ESD
BETONSCHUTZPLATTEN
PE 100-EL ESD CONCRETE
PROTECTIVE LINERS

ECTFE BETONSCHUTZPLATTE
N
ECTFE CONCRETE
PROTECTIVE LINERS

PVDF-FLEX BETONSCHUTZPLATTEN
N
PVDF-FLEX CONCRETE
PROTECTIVE LINERS

INDUKTOFIX
INDUKTOFIX

SCHWEISSDRAHT
WELDING-ROD

SCHWEISSDRAHT
 WELDING-ROD
 INDUKTOFIX
 INDUKTOFIX
 ECTFE BETONSCHUTZPLATTEN
 N
 ECTFE CONCRETE
 PROTECTIVE LINERS
 PVDF-FLEX BETONSCHUTZPLATTEN
 AATTEN
 PVDF-FLEX CONCRETE
 PROTECTIVE LINERS
 PE 100-EL ESD
 BETONSCHUTZPLATTEN
 PE 100-EL ESD CONCRETE
 PROTECTIVE LINERS
 HDPE BIONIC SCS CONCRETE
 PROTECTIVE LINERS
 HDPE BIONIC SCS CONCRETE
 PROTECTIVE LINERS
 PEHD BLAU HYDRO+
 UND HYDROCLICK
 PE 80 / HDPE BLUE HYDRO+
 AND HYDROCLICK
 PE BETONSCHUTZPLATTEN
 PE CONCRETE
 PROTECTIVE LINERS
 PP BETONSCHUTZPLATTEN
 N
 PP CONCRETE
 PROTECTIVE LINERS



PP BETONSCHUTZPLATTEN
 PP CONCRETE PROTECTIVE LINERS

AGRU-Ultra Grip BSP

Noppen 13mm - 4000X2000mm

extrudiert

Extrusionsschweissung

PPR grau

AGRU-Ultra Grip CPL

studs 13mm - 4000X2000mm

extruded

Extrusion-welding

PPR grey

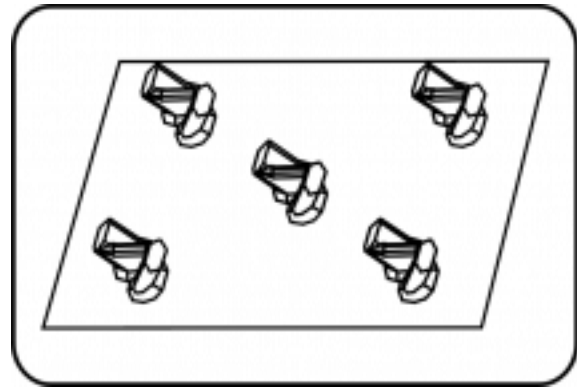

Code: 562

Dimension Dimension	Code Code	Detail Detail	b mm	thick mm	Nh mm	Lm m	Gewicht Weight
3,0	11.562.4020.30	4000X2000X3,0	2.000	3	13	4.000	3,80
5,0	11.562.4020.50	4000X2000X5,0	2.000	5	13	4.000	5,80
8,0	11.562.4020.80	4000X2000X8,0	2.000	8	13	4.000	8,80

AGRU-Ultra Grip BSP

kaschiert Polyestergewebe
Noppen 13mm - 4000X1800mm

extrudiert

Extrusionsschweissung

PPR grau

AGRU-Ultra Grip CPL

Polyester Fabric backed
studs 13mm - 4000X1800mm

extruded

Extrusion-welding

PPR grey

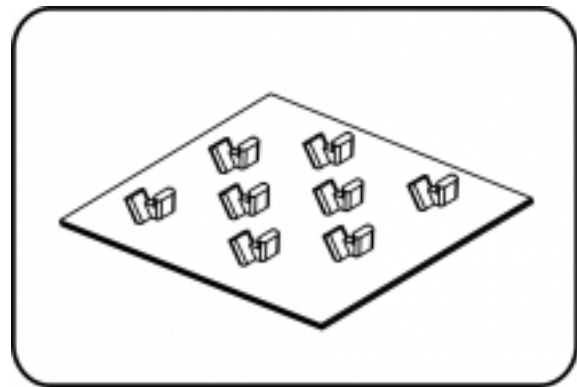

Code: 563

Dimension Dimension	Code Code	Detail Detail	L mm	b mm	thick mm	Nh mm	Gewicht Weight
5,0	11.563.4018.50	4000X1800X5,0	4.000	1.800	5	13	5,80

AGRU-Ultra Grip BSP

Noppen 13mm - 4000X2000mm

extrudiert

Extrusionsschweissung

PPB schwarz

AGRU-Ultra Grip CPL

studs 13mm - 4000X2000mm

extruded

Extrusion-welding

PPB black

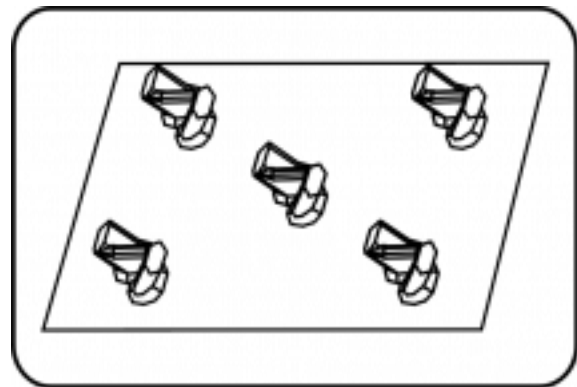

Code: 562

Dimension Dimension	Code Code	Detail Detail	b mm	thick mm	Nh mm	Lm m	Gewicht Weight
3,0	14.562.4020.30	4000X2000X3,0	2.000	3	13	4.000	3,80
5,0	14.562.4020.50	4000X2000X5,0	2.000	5	13	4.000	5,80

PP BETONSCHUTZPLATTEN
 N
 PP CONCRETE
 PROTECTIVE LINERS
 PE BETONSCHUTZPLATTEN
 PE CONCRETE
 PROTECTIVE LINERS
 PEHD BLAU HYDRO+
 UND HYDROCLICK
 PE 80 / HDPE BLUE HYDRO+
 AND HYDROCLICK
 HDPE BIONIC SCS BETONSCHUTZPLATTEN
 HDPE BIONIC SCS CONCRETE
 PROTECTIVE LINERS
 PE 100-EL ESD
 BETONSCHUTZPLATTEN
 PE 100-EL ESD CONCRETE
 PROTECTIVE LINERS
 PVDF-FLEX BETONSCHUTZPLATTEN
 PVDF-FLEX CONCRETE
 PROTECTIVE LINERS
 ECTFE BETONSCHUTZPLATTEN
 ECTFE CONCRETE
 PROTECTIVE LINERS
 INDUKTOFIX
 INDUKTOFIX
 SCHWEISSDRAHT
 WELDING-ROD



PP BETONSCHUTZPLATTEN

PP CONCRETE PROTECTIVE LINERS

Abschluss-Profil

für Betonschutzplatte

End Profile

for concrete protective liner

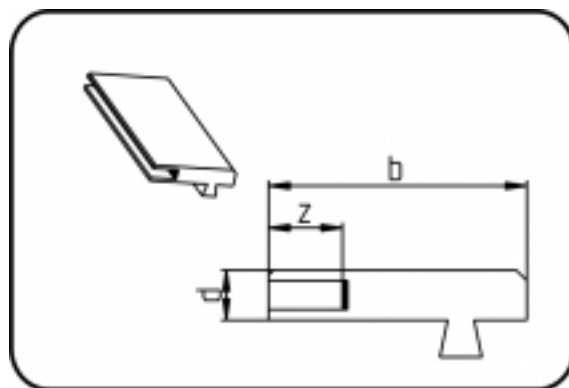

Code: 575

PPB schwarz

PPB black

Dimension Dimension	Code Code	Detail Detail	z mm	L mm	d mm	b mm	thick mm	Gewicht Weight
3,5 - 5,0	14.575.0000.50	3,5 - 5,0mm 5m	15	5.000	9,5	49	3,5	0,30

Ecken

für Betonschutzplatte

Corner

for concrete protective liner

formgespritzt

injection moulded

Montagehilfe

Installation Accessory

PPR grau

PPR grey

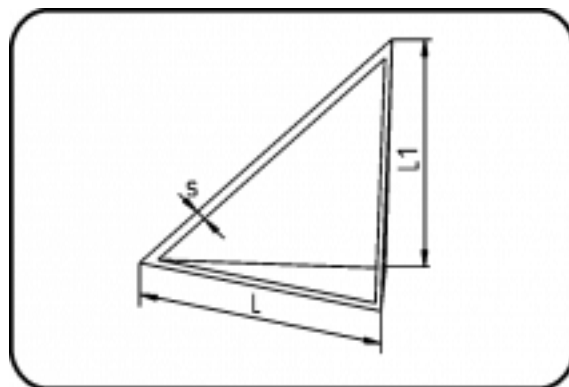

Code: 040

Dimension Dimension	Code Code	Detail Detail	s mm	L mm	L1 mm	Gewicht Weight
	11.040.0000.00		3	112	77	0,02

Betonanker

Befestigungsmittel

Concrete anchor

Mounting accessory

formgespritzt

injection moulded

PPR grau

PPR grey

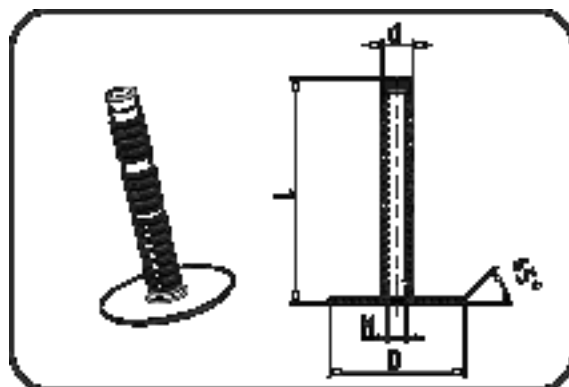







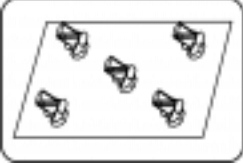

Code: 582

Dimension Dimension	Code Code	Detail Detail	d mm	d1 mm	d2 mm	L mm	Gewicht Weight
200mm M16	11.582.0200.16	200mm M16	120	16	25	200	0,12
150mm M12	11.582.0150.12	150mm M12	120	12	25	150	0,11

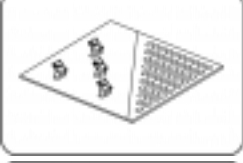
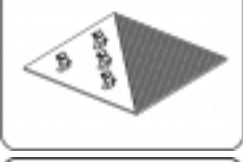
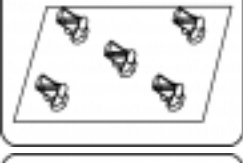
PE BETONSCHUTZPLATTEN
PE CONCRETE PROTECTIVE LINERS

BETONSCHUTZPLATTEN
CONCRETE PROTECTIVE LINERS

Seite
page

	Code: 562 AGRU-Ultra Grip BSP Noppen 13mm - 4000X2000mm extrudiert PE schwarz	AGRU-Ultra Grip CPL studs 13mm - 4000X2000mm extruded PE black	13
	Code: 562 AGRU-Ultra Grip BSP gerollt Noppen 13mm - 50000X2000mm extrudiert PE schwarz	AGRU-Ultra Grip CPL rolled studs 13mm - 50000X2000mm extruded PE black	13
	Code: 561 AGRU-Ultra Grip BSP mit Trittschutz extrudiert PE schwarz	AGRU-Ultra Grip CPL slip and slide protection extruded PE black	14
	Code: 563 AGRU-Ultra Grip BSP kaschiert Polyestergewebe extrudiert PE schwarz	AGRU-Ultra Grip CPL Polyester Fabric backed extruded PE black	14
	Code: 562 AGRU-Ultra Grip BSP gerollt Noppen 13mm - 50000X5000mm extrudiert PE schwarz	AGRU-Ultra Grip CPL rolled studs 13mm - 50000X5000mm extruded PE black	15
	Code: 562 AGRU-Ultra Grip BSP gerollt Noppen 13mm - 50000X3000mm extrudiert PE schwarz	AGRU-Ultra Grip CPL rolled studs 13mm - 50000X3000mm extruded PE black	15
	Code: 569 AGRU-Ultra Grip BSP gerollt Noppen 13mm - 50000X5000mm co-extrudiert PE schwarz/weiss	AGRU-Ultra Grip CPL rolled studs 13mm - 50000X5000mm co-extruded PE black/white	16
	Code: 569 AGRU-Ultra Grip BSP gerollt Noppen 13mm - 50000X3000mm co-extrudiert PE schwarz/weiss	AGRU-Ultra Grip CPL rolled studs 13mm - 50000X3000mm co-extruded PE black/white	16
	Code: 562 AGRU-Ultra Grip BSP gerollt Noppen 13mm - 50000X5000mm extrudiert PE gelb RAL1003	AGRU-Ultra Grip CPL rolled studs 13mm - 50000X5000mm extruded PE yellow RAL1003	17
	Code: 562 AGRU-Ultra Grip BSP gerollt Noppen 13mm - 50000X3000mm extrudiert PE gelb RAL1003	AGRU-Ultra Grip CPL rolled studs 13mm - 50000X3000mm extruded PE yellow RAL1003	17

PE BETONSCHUTZPLATTEN
PP CONCRETE PROTECTIVE LINERS
PE BETONSCHUTZPLATTEN
N
PE CONCRETE PROTECTIVE LINERS
PEHD BLAU HYDRO+ UND HYDROCLICK
HDPE BIONIC SCS CONCRETE PE 80 / HDPE BLUE HYDRO+ AND HYDROCLICK
PEHD BIONIC SCS BETONSCHUTZPLATTEN
UND HYDROCLICK
HDPE BIONIC SCS CONCRETE PE 80 / HDPE BLUE HYDRO+ AND HYDROCLICK
PE 100-EL ESD BETONSCHUTZPLATTEN
PE 100-EL ESD CONCRETE PROTECTIVE LINERS
PE 100-EL ESD BETONSCHUTZPLATTEN
ATTEN
PVD-FLEX CONCRETE PROTECTIVE LINERS
ECTFE BETONSCHUTZPLATTEN
N
ECTFE CONCRETE PROTECTIVE LINERS
INDUKTOFIX
INDUKTOFIX
SCHWEISSDRAHT
WELDING-ROD

PE BETONSCHUTZPLATTEN
 PP CONCRETE
 PROTECTIVE LINERS
 PE BETONSCHUTZPLATTEN
 N
 PE CONCRETE
 PROTECTIVE LINERS
 PEHD BIONIC SCS BETONSCHUTZPLATTEN
 PE 80 / PEHD BLAU HYDRO+
 UND HYDROCLICK
 HDPE BIONIC SCS CONCRETE
 PE 80 / HDPE BLUE HYDRO+
 AND HYDROCLICK
 PEHD BIONIC SCS BETONSCHUTZPLATTEN
 UTZPLATTEN
 HDPE BIONIC SCS CONCRETE
 PE 80 / HDPE BLUE HYDRO+
 AND HYDROCLICK
 PE 100-EL ESD
 BETONSCHUTZPLATTEN
 PE 100-EL ESD CONCRETE
 PROTECTIVE LINERS
 PEHD BIONIC SCS BETONSCHUTZPLATTEN
 ATTEN
 PVD-F-FLEX CONCRETE
 PROTECTIVE LINERS
 PEHD BIONIC SCS BETONSCHUTZPLATTEN
 N
 ECTFE CONCRETE
 PROTECTIVE LINERS
 INDUKTOFIX
 INDUKTOFIX
 SCHWEISSDRAHT
 WELDING-ROD

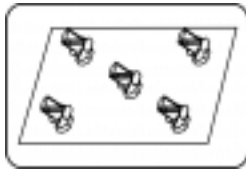

Code: 562
AGRU-Ultra Grip BSP gerollt
Noppen 13mm - 50000X3000mm
extrudiert
PE achatgrau RAL7038

AGRU-Ultra Grip CPL rolled
studs 13mm - 50000X3000mm
extruded
PE agate grey RAL7038

18

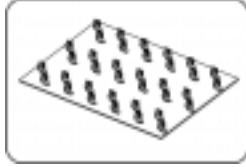

Code: 558
AGRU-Sure Grip Mini BSP
Noppen 7,5mm - 50000X3000mm
extrudiert
PE gelb RAL1003

AGRU-Sure Grip Mini CPL
studs 7.5mm - 50000X3000mm
extruded
PE yellow RAL1003

18

PROFILE, BETONANKER
PROFILES, CONCRETE ANCHORS

Seite
page

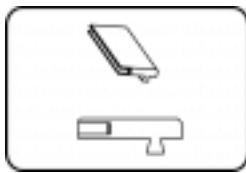

Code: 575
Abschluss-Profil
für Betonschutzplatte
co-extrudiert
PE schwarz

End Profile
for concrete protective liner
co-extruded
PE black

19

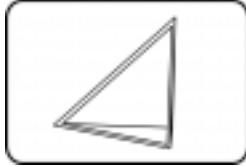

Code: 040
Ecken
für Betonschutzplatte
formgespritzt
PE schwarz

Corner
for concrete protective liner
injection moulded
PE black

19



Code: 571
Abreissprofil
für Betonschutzplatte
extrudiert
PE 100-el schwarz

Tear Off Profile
for concrete protective liner
extruded
PE 100-el black

19



Code: 592.3
Fugenbandprofil 3-stegig
extrudiert
PEVLD schwarz

Waterstop Profile 3-Ribs
extruded
VLDPE black

20

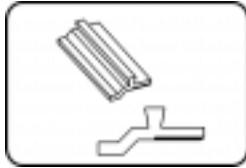

Code: 576
Anbindeprofil kurz
für Betonschutzplatte
co-extrudiert
PEHD gelb

Connection Profile short
for concrete protective liner
co-extruded
HDPE yellow

20

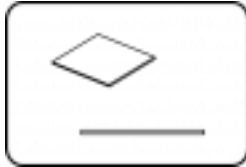

Code: 578
Abdeckstreifen
für Betonschutzplatte
extrudiert
PE gelb RAL1003

Cover Strip
for concrete protective liner
extruded
PE yellow RAL1003

20

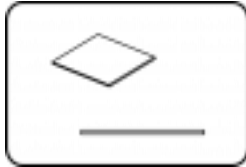

Code: 578
Abdeckstreifen
für Betonschutzplatte
extrudiert
PE achatgrau RAL7038

Cover Strip
for concrete protective liner
extruded
PE agate grey RAL7038

21

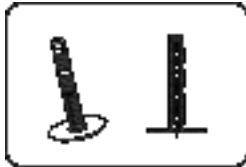

Code: 582
Betonanker
Befestigungsmittel
formgespritzt
PEHD schwarz

Concrete anchor
Mounting accessory
injection moulded
HDPE black

21

AGRU-Ultra Grip BSP

Noppen 13mm - 4000X2000mm

extrudiert

Extrusionsschweissung

PE schwarz

AGRU-Ultra Grip CPL

studs 13mm - 4000X2000mm

extruded

Extrusion-welding

PE black

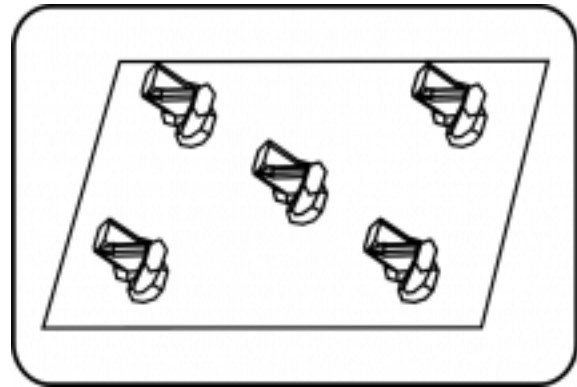

Code: 562

Dimension Dimension	Code Code	Detail Detail	b mm	thick mm	Nh mm	Lm m	Gewicht Weight
2,0	27.562.4020.20	4000X2000X2,0	2.000	2	13	4	2,80
2,5	27.562.4020.25	4000X2000X2,5	2.000	2,5	13	4	3,30
3,0	27.562.4020.30	4000X2000X3,0 DIBt	2.000	3	13	4	3,80
4,0	27.562.4020.40	4000X2000X4,0 DIBt	2.000	4	13	4	4,80
5,0	27.562.4020.50	4000X2000X5,0 DIBt	2.000	5	13	4	5,80
8,0	27.562.4020.80	4000X2000X8,0	2.000	8	13	4	8,80
10,0	27.562.4020.10	4000X2000X10,0	2.000	10	13	4	10,80
12,0	27.562.4020.12	4000X2000X12,0	2.000	12	13	4	12,80

**AGRU-Ultra Grip BSP
gerollt**

Noppen 13mm -
50000X2000mm

extrudiert

Extrusionsschweissung

PE schwarz

**AGRU-Ultra Grip CPL
rolled**

studs 13mm - 50000X2000mm

extruded

Extrusion-welding

PE black

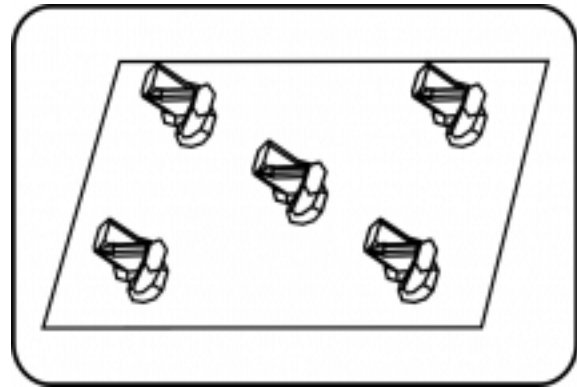

Code: 562

Dimension Dimension	Code Code	Detail Detail	b mm	thick mm	Nh mm	Lm m	Gewicht Weight
2,0	27.562.5020.20	50000X2000X2,0	2.000	2	13	50	2,80
3,0	27.562.5020.30	50000X2000X3,0 DIBt	2.000	3	13	50	3,80
5,0	27.562.5020.50	50000X2000X5,0 DIBt	2.000	5	13	50	5,80

PE BETONSCHUTZPLATTEN
PP CONCRETE
PROTECTIVE LINERS

PE BETONSCHUTZPLATTE
N
PE CONCRETE
PROTECTIVE LINERS

PEHD BIONIC SCS BETONSCHUPE 80 / PEHD BLAU HYDRO+
UND HYDROCLICK
HDPE BIONIC SCS CONCRETE PE 80 / HDPE BLUE HYDRO+
AND HYDROCLICK

PE 100-EL ESD
BETONSCHUTZPLATTEN
PE 100-EL ESD CONCRETE
PROTECTIVE LINERS

ECTIFE BETONSCHUTZPLATTE (PVDF-FLEX BETONSCHUTZPL
ATTEN
PVDF-FLEX CONCRETE
PROTECTIVE LINERS

INDUKTOFIX
INDUKTOFIX

SCHWEISSDRAHT
WELDING-ROD

PE BETONSCHUTZPLATTEN
 PP CONCRETE
 PROTECTIVE LINERS
 PE BETONSCHUTZPLATTEN
 N
 PE CONCRETE
 PROTECTIVE LINERS
 PEHD BIONIC SCS BETONSCHUTZPLATTEN
 PE 80 / PEHD BLAU HYDRO+
 UND HYDROCLICK
 HDPE BIONIC SCS CONCRETE
 PE 80 / HDPE BLUE HYDRO+
 AND HYDROCLICK
 PE 100-EL ESD
 BETONSCHUTZPLATTEN
 PE 100-EL ESD CONCRETE
 PROTECTIVE LINERS
 PVDF-FLEX BETONSCHUTZPLATTEN
 PVDF-FLEX CONCRETE
 PROTECTIVE LINERS
 ECTFE BETONSCHUTZPLATTEN
 N
 ECTFE CONCRETE
 PROTECTIVE LINERS
 INDUKTOFIX
 INDUKTOFIX
 SCHWEISSDRAHT
 WELDING-ROD



AGRU-Ultra Grip BSP

mit Trittschutz
Noppen 13mm - 4000X1800mm
extrudiert

Extrusionsschweissung

PE schwarz

AGRU-Ultra Grip CPL

slip and slide protection
studs 13mm - 4000X1800mm
extruded

Extrusion-welding

PE black

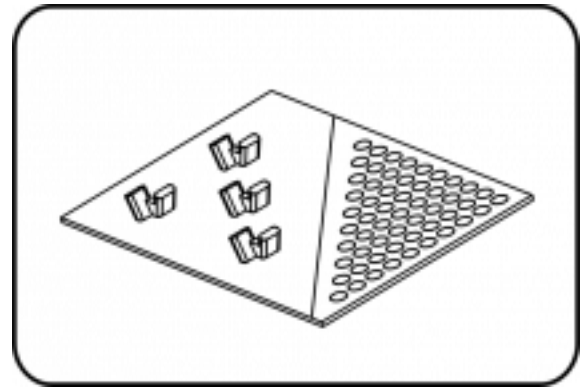

Code: 561

Dimension Dimension	Code Code	Detail Detail	L mm	b mm	thick mm	Nh mm	Gewicht Weight
5,0	27.561.4018.50	4000X1800X5,0 DIBt	4.000	1.800	5	13	6,20

AGRU-Ultra Grip BSP

kaschiert Polyestergewebe
Noppen 13mm - 4000X1800mm
extrudiert

Extrusionsschweissung

PE schwarz

AGRU-Ultra Grip CPL

Polyester Fabric backed
studs 13mm - 4000X1800mm
extruded

Extrusion-welding

PE black

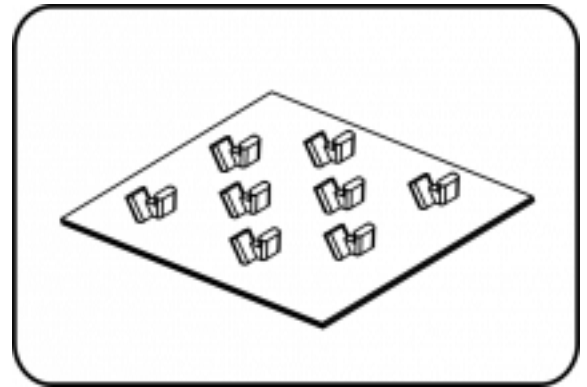

Code: 563

Dimension Dimension	Code Code	Detail Detail	L mm	b mm	thick mm	Nh mm	Gewicht Weight
5,0	27.563.4018.50	4000X1800X5,0	4.000	1.800	5	13	5,80

**AGRU-Ultra Grip BSP
gerollt**

Noppen 13mm -
50000X5000mm

extrudiert

Extrusionsschweissung

PE schwarz

**AGRU-Ultra Grip CPL
rolled**

studs 13mm - 50000X5000mm

extruded

Extrusion-welding

PE black

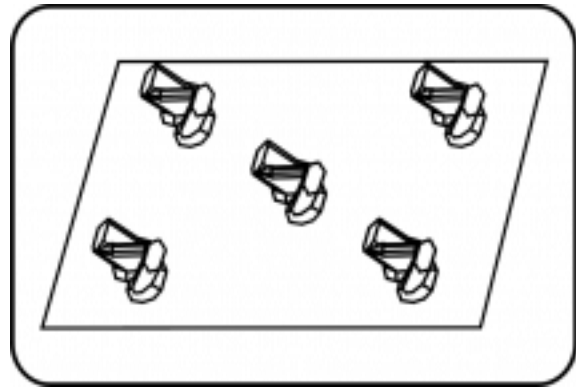

Code: 562

Dimension Dimension	Code Code	Detail Detail	b mm	thick mm	Nh mm	Lm m	Gewicht Weight
2,0	27.562.5050.20	50000X5000X2,0	5.000	2	13	50	2,80
2,5	27.562.5050.25	50000X5000X2,5	5.000	2,5	13	50	3,30
3,0	27.562.5050.30	50000X5000X3,0 DIBt	5.000	3	13	50	3,80
4,0	27.562.5050.40	50000X5000X4,0 DIBt	5.000	4	13	50	4,80
5,0	27.562.5050.50	50000X5000X5,0 DIBt	5.000	5	13	50	5,80

Keine Lagerware.
Not available from stock.

**AGRU-Ultra Grip BSP
gerollt**

Noppen 13mm -
50000X3000mm

extrudiert

Extrusionsschweissung

PE schwarz

**AGRU-Ultra Grip CPL
rolled**

studs 13mm - 50000X3000mm

extruded

Extrusion-welding

PE black

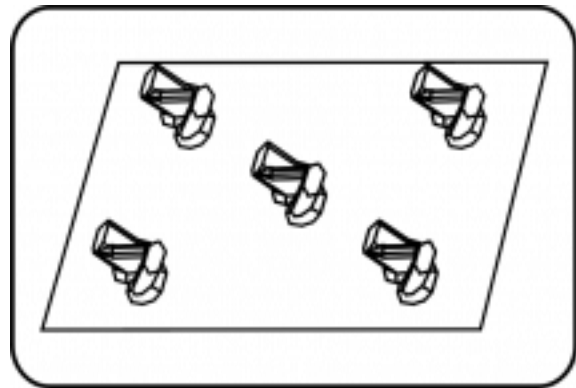

Code: 562

Dimension Dimension	Code Code	Detail Detail	b mm	thick mm	Nh mm	Lm m	Gewicht Weight
2,0	27.562.5030.20	50000X3000X2,0	3.000	2	13	50	2,80
2,5	27.562.5030.25	50000X3000X2,5	3.000	2,5	13	50	3,30
3,0	27.562.5030.30	50000X3000X3,0 DIBt	3.000	3	13	50	3,80
4,0	27.562.5030.40	50000X3000X4,0 DIBt	3.000	4	13	50	4,80
5,0	27.562.5030.50	50000X3000X5,0 DIBt	3.000	5	13	50	5,80

Keine Lagerware.
Not available from stock.

PE BETONSCHUTZPLATTEN
PP CONCRETE PROTECTIVE LINERS
PE BETONSCHUTZPLATTE
N
PE CONCRETE PROTECTIVE LINERS
PEHD BIONIC SCS BETONSCHUTZPLATTE
PEHD BIONIC SCS CONCRETE PROTECTIVE LINERS
PEHD BIONIC SCS CONCRETE PROTECTIVE LINERS
PEHD BIONIC SCS CONCRETE PROTECTIVE LINERS
PE 100-EL ESD BETONSCHUTZPLATTEN
PE 100-EL ESD CONCRETE PROTECTIVE LINERS
PE 100-EL ESD CONCRETE PROTECTIVE LINERS
PVD-F-FLEX BETONSCHUTZPLATTEN
PVD-F-FLEX CONCRETE PROTECTIVE LINERS
ECTIFE BETONSCHUTZPLATTE
N
ECTIFE CONCRETE PROTECTIVE LINERS
INDUKTOFIX
INDUKTOFIX
SCHWEISSDRAHT
WELDING-ROD

**AGRU-Ultra Grip BSP
gerollt**

Noppen 13mm -
50000X5000mm

co-extrudiert

Extrusionsschweissung

PE schwarz/weiss

**AGRU-Ultra Grip CPL
rolled**

studs 13mm - 50000X5000mm

co-extrudiert

Extrusion-welding

PE black/white

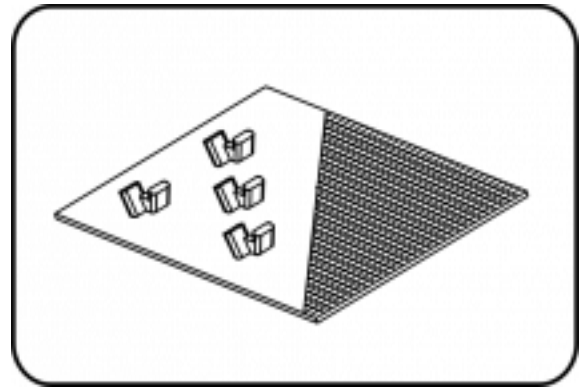

Code: 569

Dimension Dimension	Code Code	Detail Detail	Lm m	b mm	thick mm	Nh mm	Gewicht Weight
2,0	27.569.5050.20	50000X5000X2,0	50	5.000	2	13	2,80
2,5	27.569.5050.25	50000X5000X2,5	50	5.000	2,5	13	3,30
3,0	27.569.5050.30	50000X5000X3,0	50	5.000	3	13	3,80
4,0	27.569.5050.40	50000X5000X4,0	50	5.000	4	13	4,80
5,0	27.569.5050.50	50000X5000X5,0	50	5.000	5	13	5,80

Keine Lagerware.
Not available from stock.

**AGRU-Ultra Grip BSP
gerollt**

Noppen 13mm -
50000X3000mm

co-extrudiert

Extrusionsschweissung

PE schwarz/weiss

**AGRU-Ultra Grip CPL
rolled**

studs 13mm - 50000X3000mm

co-extrudiert

Extrusion-welding

PE black/white

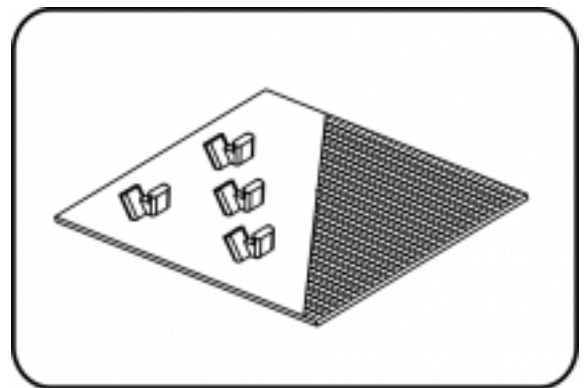

Code: 569

Dimension Dimension	Code Code	Detail Detail	Lm m	b mm	thick mm	Nh mm	Gewicht Weight
2,0	27.569.5030.20	50000X3000X2,0	50	3.000	2	13	2,80
2,5	27.569.5030.25	50000X3000X2,5	50	3.000	2,5	13	3,30
3,0	27.569.5030.30	50000X3000X3,0	50	3.000	3	13	3,80
4,0	27.569.5030.40	50000X3000X4,0	50	3.000	3	13	4,80
5,0	27.569.5030.50	50000X3000X5,0	50	3.000	3	13	5,80

Keine Lagerware.
Not available from stock.

**AGRU-Ultra Grip BSP
gerollt**

Noppen 13mm -
50000X5000mm

extrudiert

Extrusionsschweissung

PE gelb RAL1003

**AGRU-Ultra Grip CPL
rolled**

studs 13mm - 50000X5000mm

extruded

Extrusion-welding

PE yellow RAL1003

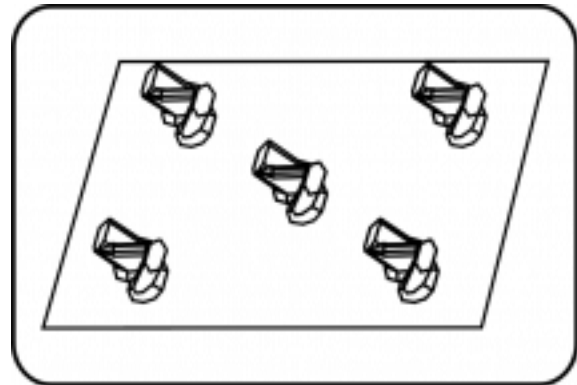

Code: 562

Dimension Dimension	Code Code	Detail Detail	b mm	thick mm	Nh mm	Lm m	Gewicht Weight
2,0	21.562.5050.20	50000X5000X2,0	5.000	2	13	50	2,80
2,5	21.562.5050.25	50000X5000X2,5	5.000	2,5	13	50	3,30
3,0	21.562.5050.30	50000X5000X3,0	5.000	3	13	50	3,80
4,0	21.562.5050.40	50000X5000X4,0	5.000	4	13	50	4,80
5,0	21.562.5050.50	50000X5000X5,0	5.000	5	13	50	5,80

Keine Lagerware.
Not available from stock.

**AGRU-Ultra Grip BSP
gerollt**

Noppen 13mm -
50000X3000mm

extrudiert

Extrusionsschweissung

PE gelb RAL1003

**AGRU-Ultra Grip CPL
rolled**

studs 13mm - 50000X3000mm

extruded

Extrusion-welding

PE yellow RAL1003

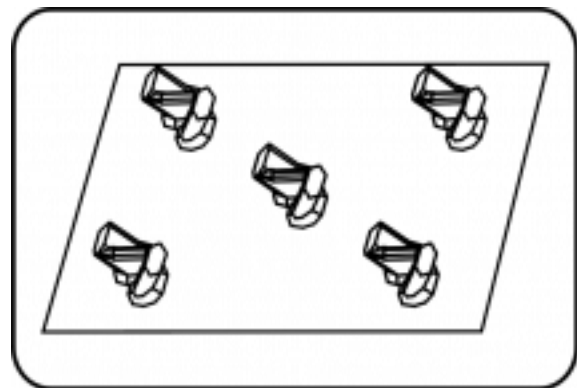

Code: 562

Dimension Dimension	Code Code	Detail Detail	b mm	thick mm	Nh mm	Lm m	Gewicht Weight
2,0	21.562.5030.20	50000X3000X2,0	3.000	2	13	50	2,80
2,5	21.562.5030.25	50000X3000X2,5	3.000	2,5	13	50	3,30
3,0	21.562.5030.30	50000X3000X3,0	3.000	3	13	50	3,80
4,0	21.562.5030.40	50000X3000X4,0	3.000	4	13	50	4,80
5,0	21.562.5030.50	50000X3000X5,0	3.000	5	13	50	5,80

Keine Lagerware.
Not available from stock.

PE BETONSCHUTZPLATTEN
PP CONCRETE
PROTECTIVE LINERS
PE BETONSCHUTZPLATTE
N
PE CONCRETE
PROTECTIVE LINERS
PEHD BIONIC SCS BETONSCHUPE 80 / PEHD BLAU HYDRO+
UND HYDROCLICK
HDPE BIONIC SCS CONCRETE PE 80 / HDPE BLUE HYDRO+
AND HYDROCLICK
PE 100-EL ESD
BETONSCHUTZPLATTEN
PE 100-EL ESD CONCRETE
PROTECTIVE LINERS
PVDF-FLEX CONCRETE
PROTECTIVE LINERS
ECTIFE BETONSCHUTZPLATTE
N
ECTIFE CONCRETE
PROTECTIVE LINERS
INDUKTOFIX
INDUKTOFIX
SCHWEISSDRAHT
WELDING-ROD

PE BETONSCHUTZPLATTEN
 PP CONCRETE
 PROTECTIVE LINERS
 PE BETONSCHUTZPLATTE
 N
 PE CONCRETE
 PROTECTIVE LINERS
 PEHD BIONIC SCS BETONSCHUTZPLATTEN
 PE 80 / PEHD BLAU HYDRO+
 UND HYDROCLICK
 HDPE BIONIC SCS CONCRETE
 PE 80 / HDPE BLAU HYDRO+
 AND HYDROCLICK
 PE 100-EL ESD
 BETONSCHUTZPLATTEN
 PE 100-EL ESD CONCRETE
 PROTECTIVE LINERS
 PVDF-FLEX BETONSCHUTZPLATTEN
 PVDF-FLEX CONCRETE
 PROTECTIVE LINERS
 ECTFE BETONSCHUTZPLATTEN
 N
 ECTFE CONCRETE
 PROTECTIVE LINERS
 INDUKTOFIX
 INDUKTOFIX
 SCHWEISSDRAHT
 WELDING-ROD



AGRU-Ultra Grip BSP gerollt

Noppen 13mm -
50000X3000mm
1 Jahr UV stabilisiert

extrudiert

Extrusionsschweissung

PE achatgrau RAL7038

AGRU-Ultra Grip CPL rolled

studs 13mm - 50000X3000mm

1 year UV stabilized

extruded

Extrusion-welding

PE agate grey RAL7038

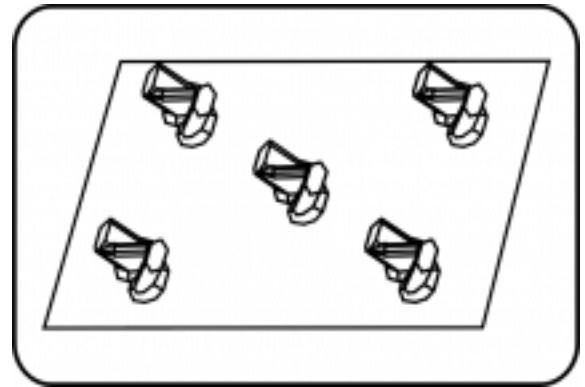

Code: 562

Dimension Dimension	Code Code	Detail Detail	b mm	thick mm	Nh mm	Lm m	Gewicht Weight
2,0	56.562.5030.20	50000X3000X2,0	3.000	2	13	50	2,80
2,5	56.562.5030.25	50000X3000X2,5	3.000	2,5	13	50	3,30
3,0	56.562.5030.30	50000X3000X3,0	3.000	3	13	50	3,80
4,0	56.562.5030.40	50000X3000X4,0	3.000	4	13	50	4,80
5,0	56.562.5030.50	50000X3000X5,0	3.000	5	13	50	5,80

Keine Lagerware.
Not available from stock.

AGRU-Sure Grip Mini BSP

Noppen 7,5mm -
50000X3000mm
gerollt

extrudiert

Extrusionsschweissung

PE gelb RAL1003

AGRU-Sure Grip Mini CPL

studs 7.5mm - 50000X3000mm

rolled

extruded

Extrusion-welding

PE yellow RAL1003

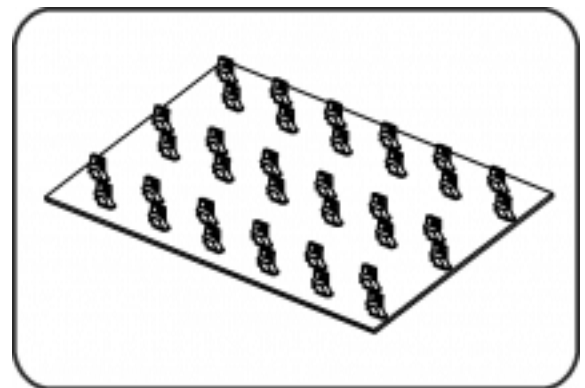

Code: 558

Dimension Dimension	Code Code	Detail Detail	b mm	thick mm	Nh mm	Lm m	Gewicht Weight
1,65	21.558.5030.16	50000X3000X1,65	3.000	1,65	7,5	50	2,05
1,8	21.558.5030.18	50000X3000X1,8	3.000	1,8	7,5	50	2,20
2,0	21.558.5030.20	50000X3000X2,0	3.000	2	7,5	50	2,40

Keine Lagerware.
Not available from stock.

Abschluss-Profil

für Betonschutzplatte

co-extrudiert

Montagehilfe

PE schwarz

End Profile

for concrete protective liner

co-extruded

Installation Accessory

PE black

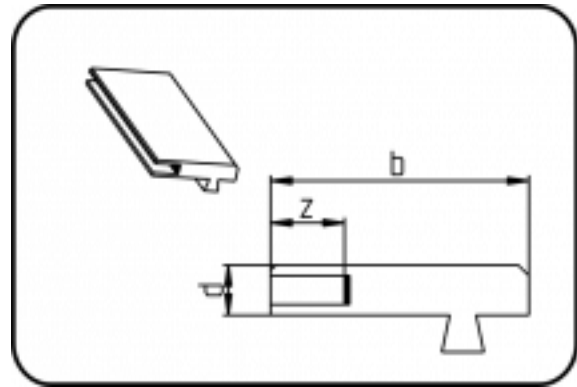

Code: 575

Dimension Dimension	Code Code	Detail Detail	z mm	L mm	d mm	b mm	thick mm	Gewicht Weight
2,5 - 3,0	27.575.0000.30	2,5 - 3,0mm 5m	15	5.000	8	48	2,5	0,24
3,5 - 5,0	27.575.0000.50	3,5 - 5,0mm 5m	15	5.000	9,5	49	3,5	0,31

Ecken

für Betonschutzplatte

formgespritzt

Montagehilfe

PE schwarz

Corner

for concrete protective liner

injection moulded

Installation Accessory

PE black

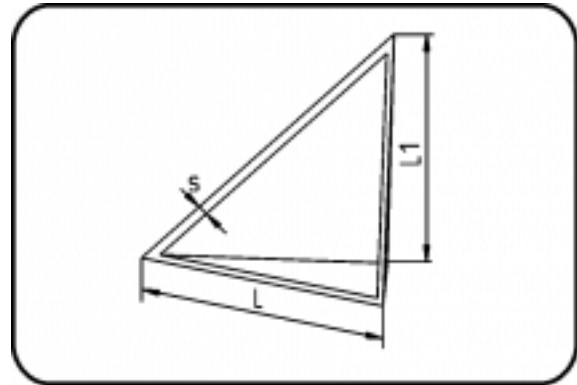

Code: 040

Dimension Dimension	Code Code	Detail Detail	s mm	L mm	L1 mm	Gewicht Weight
3	27.040.0000.00	3/112/77	3	112	77	0,02

Abreissprofil

für Betonschutzplatte

extrudiert

Montagehilfe

PE 100-el schwarz

Tear Off Profile

for concrete protective liner

extruded

Installation Accessory

PE 100-el black

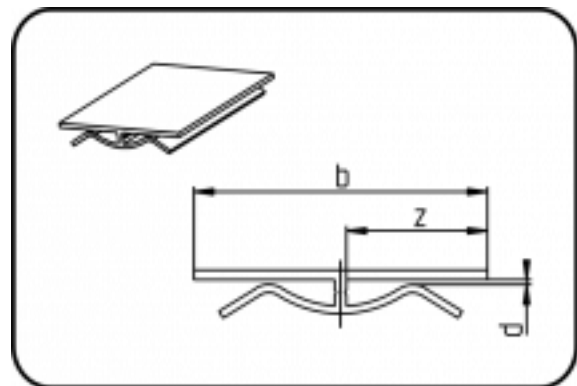

Code: 571

Dimension Dimension	Code Code	Detail Detail	z mm	L mm	d mm	b mm	Gewicht Weight
2,0 - 5,0	28.571.0000.50	2,0 - 5,0mm 5m	24,5	5.000	4,6	52	0,16

PE BETONSCHUTZPLATTEN
PP CONCRETE PROTECTIVE LINERS
PE BETONSCHUTZPLATTE
N
PE CONCRETE PROTECTIVE LINERS
PEHD BIONIC SCS BETONSCHUTZPLATTE
PEHD BLAU HYDRO+
UND HYDROCLICK
HDPE BIONIC SCS CONCRETE PE 80 / HDPE BLUE HYDRO+
PROTECTIVE LINERS
AND HYDROCLICK
PE 100-EL ESD
BETONSCHUTZPLATTEN
PE 100-EL ESD CONCRETE
PROTECTIVE LINERS
PVD-FLEX CONCRETE
PROTECTIVE LINERS
ATTEN
ECTIFE BETONSCHUTZPLATTE
N
ECTIFE CONCRETE
PROTECTIVE LINERS
INDUKTOFIX
INDUKTOFIX
SCHWEISSDRAHT
WELDING-ROD

Fugenbandprofil 3-stegig **Waterstop Profile 3-Ribs**

extrudiert

extruded

Extrusionsschweissung **Extrusion-welding**

PEVLD schwarz **VLDPE black**

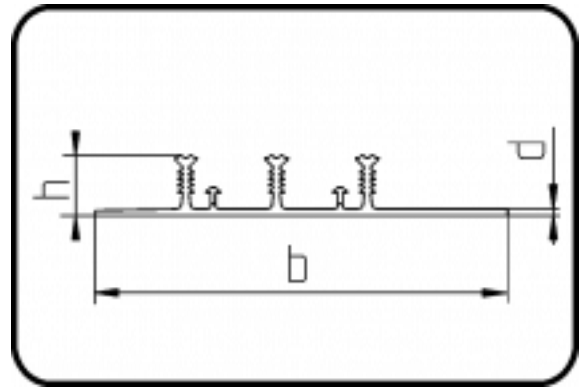

Code: 592.3

Dimension Dimension	Code Code	Detail Detail	d mm	h mm	b mm	Gewicht Weight
4	60.592.3250.04	250X37mm L25m	4	38	250	1,49

Keine Lagerware.
Not available from stock.

Anbindeprofil kurz **Connection Profile short**

für Betonschutzplatte for concrete protective liner

co-extrudiert co-extruded

Montagehilfe **Installation Accessory**

PEHD gelb **HDPE yellow**

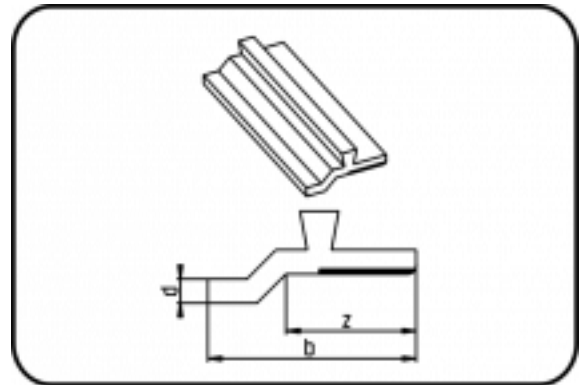

Code: 576

Dimension Dimension	Code Code	Detail Detail	z mm	L mm	b mm	thick mm	Gewicht Weight
3,0	21.576.0000.30	3,0 5m	27	5.000	42	3	0,15

Abdeckstreifen **Cover Strip**

für Betonschutzplatte for concrete protective liner

extrudiert extruded

Montagehilfe **Installation Accessory**

PE gelb RAL1003 **PE yellow RAL1003**

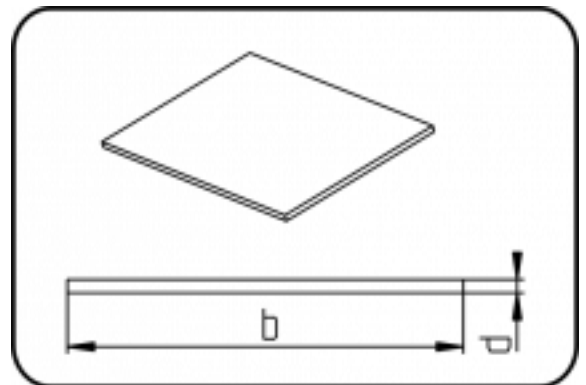

Code: 578

Dimension Dimension	Code Code	Detail Detail	thick mm	Gewicht Weight
3,0	21.578.0110.30	100mX110mmX3mm	3	0,35
3,0	21.578.0160.30	100mX160mmX3mm	3	0,50

Abdeckstreifen

für Betonschutzplatte
1 Jahr UV stabilisiert
extrudiert

Montagehilfe

PE achatgrau RAL7038

Cover Strip

for concrete protective liner
1 year UV stabilized
extruded

Installation Accessory

PE agate grey RAL7038

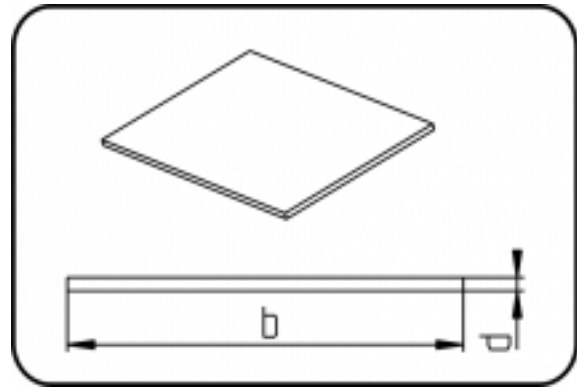

Code: 578

Dimension Dimension	Code Code	Detail Detail	thick mm	Gewicht Weight
3	56.578.0110.30	100mX110mmX3mm	3	0,35
3	56.578.0160.30	100mX160mmX3mm	3	0,50

Betonanker

Befestigungsmittel

formgespritzt

PEHD schwarz

Concrete anchor

Mounting accessory

injection moulded

HDPE black

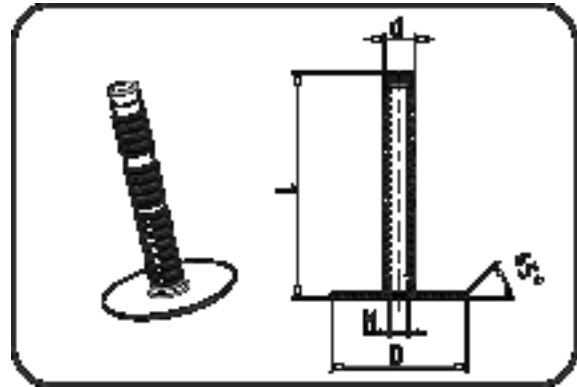

Code: 582

Dimension Dimension	Code Code	Detail Detail	d mm	d1 mm	d2 mm	L mm	Gewicht Weight
200mm M16	27.582.0200.16	200mm M16	120	16	25	200	0,12
150mm M16	27.582.0150.16	150mm M16	120	16	25	150	0,10
200mm M12	27.582.0200.12	200mm M12	120	12	25	200	0,13
150mm M12	27.582.0150.12	150mm M12	120	12	25	150	0,11

PE BETONSCHUTZPLATTEN
PP CONCRETE PROTECTIVE LINERS
PE BETONSCHUTZPLATTEN
N
PE CONCRETE PROTECTIVE LINERS
PEHD BIONIC SCS BETONSCHUTZPLATTEN
PEHD BIONIC SCS CONCRETE PROTECTIVE LINERS
PE 100-EL ESD BETONSCHUTZPLATTEN
PE 100-EL ESD CONCRETE PROTECTIVE LINERS
PE 100-EL ESD BETONSCHUTZPLATTEN
PE 100-EL ESD CONCRETE PROTECTIVE LINERS
PE 100-EL ESD BETONSCHUTZPLATTEN
PE 100-EL ESD CONCRETE PROTECTIVE LINERS
INDUKTOFIX
INDUKTOFIX
SCHWEISSDRAHT
WELDING-ROD



PE 80 / PEHD BLAU HYDRO+ UND HYDROCLICK

PE 80 / HDPE BLUE HYDRO+ AND HYDROCLICK

HYDRO+
HYDRO+

Seite
page

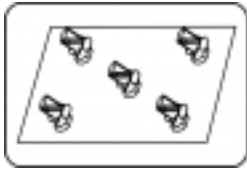

Code: 562

AGRU-Ultra Grip BSP
für Trinkwasseranwendung
extrudiert
PE 80 blau RAL5012

AGRU-Ultra Grip CPL
for potable water supply
extruded
PE 80 blue RAL5012

27

HYDROCLICK
HYDROCLICK

Seite
page

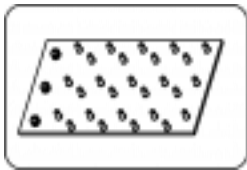

Code: 574

HYDROCLICK Platte
für Trinkwasseranwendung
extrudiert
PE 80 blau RAL5012

HYDROCLICK Sheet
for potable water supply
extruded
PE 80 blue RAL5012

28

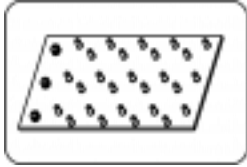

Code: 574

HYDROCLICK Platte gerollt
für Trinkwasseranwendung
extrudiert
PE 80 blau RAL5012

HYDROCLICK Sheet rolled
for potable water supply
extruded
PE 80 blue RAL5012

28

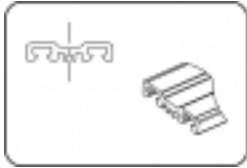

Code: 579

HYDROCLICK Profil
Montagehilfe
co-extrudiert
PE 100-RC schwarz

HYDROCLICK Profile
Installation accessory
co-extruded
PE 100-RC black

28

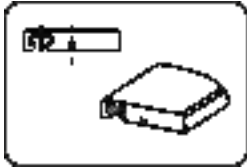

Code: 579.1

HYDROCLICK Profil einseitig
Montagehilfe
mechanisch gefertigt
PE 100 / PE 100-RC schwarz

HYDROCLICK Profile one sided
Installation accessory
machined
PE 100 / PE 100-RC black

29

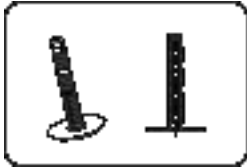

Code: 582

Betonanker
Befestigungsmittel
formgespritzt
PE 80 blau RAL5012

Concrete anchor
Mounting accessory
injection moulded
PE 80 blue RAL5012

29

PLATTEN
SHEETS

Seite
page

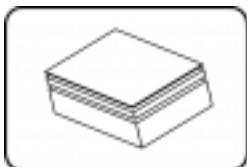

Code: 600

Platte KTW/EN16421
für Trinkwasseranwendung
extrudiert
PEHD blau RAL5012

Sheet KTW/EN16421
for potable water supply
extruded
HDPE blue RAL5012

30

PE BETONSCHUTZPLATTEN
PP CONCRETE
PROTECTIVE LINERS
PE BETONSCHUTZPLATTEN
PP CONCRETE
PROTECTIVE LINERS
PE 80 / PEHD BLAU
HYDRO+ UND HYDROCLICK
PE 80 / HDPE BLUE
HYDRO+ AND HYDROCLICK
PEHD BIONIC SCS BETONSCHUTZPLATTEN
UTZPLATTEN
HDPE BIONIC SCS CONCRETE
PROTECTIVE LINERS
PE 100-EL ESD
BETONSCHUTZPLATTEN
PE 100-EL ESD CONCRETE
PROTECTIVE LINERS
ECTFE BETONSCHUTZPLATTE
N
ATTEN
PVD-F-FLEX CONCRETE
PROTECTIVE LINERS
INDUKTOFIX
INDUKTOFIX
SCHWEISSDRAHT
WELDING-ROD



SCHWEISSDRAHT WELDING-ROD	INDUKTOFIX INDUKTOFIX	ECTFE BETONSCHUTZPLATTE N ECTFE CONCRETE PROTECTIVE LINERS	PVDF-FLEX BETONSCHUTZPLATTEN ATTEN PVDF-FLEX CONCRETE PROTECTIVE LINERS	PE 100-EL ESD BETONSCHUTZPLATTEN PE 100-EL ESD CONCRETE PROTECTIVE LINERS	PEHD BIONIC SCS BETONSCHUTZPLATTEN UTZPLATTEN HDPE BIONIC SCS CONCRETE PROTECTIVE LINERS	PE 80 / PEHD BLAU HYDRO+ UND HYDROCLICK PE 80 / HDPE BLUE HYDRO+ AND HYDROCLICK	PE BETONSCHUTZPLATTEN PE CONCRETE PROTECTIVE LINERS	PE BETONSCHUTZPLATTEN PP CONCRETE PROTECTIVE LINERS
------------------------------	--------------------------	---	--	--	---	--	---	---

AGRU-Ultra Grip BSP

für Trinkwasseranwendung

extrudiert

Extrusionsschweissung

PE 80 blau RAL5012

AGRU-Ultra Grip CPL

for potable water supply

extruded

Extrusion-welding

PE 80 blue RAL5012

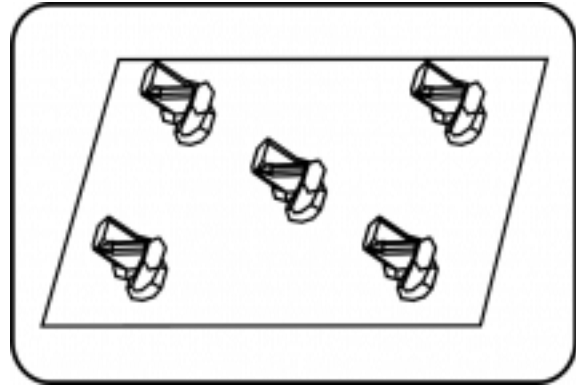

Code: 562

Dimension Dimension	Code Code	Detail Detail	b mm	thick mm	Nh mm	Lm m	Gewicht Weight
5,0	86.562.4020.50	4000X2000X5,0	2000	5	13	4.000	5,80

PE 80 / PEHD BLAU HYDRO+ UND HYDROCLICK
 PE 80 / HDPE BLUE HYDRO+ AND HYDROCLICK
 PEHD BIONIC SCS BETONSC
 HUTZPLATTEN
 HDPE BIONIC SCS CONCRETE
 PROTECTIVE LINERS
 PE 100-EL ESD
 BETONSC
 HUTZPLATTEN
 PE 100-EL ESD CONCRETE
 PROTECTIVE LINERS
 PVD
 F-FLEX BETONSC
 HUTZPLATTEN
 PVD
 F-FLEX CONCRETE
 PROTECTIVE LINERS
 ECTFE
 CONCRETE
 PROTECTIVE LINERS
 INDUKTOFIX
 INDUKTOFIX
 SCHWEISSDRAHT
 WELDING-ROD

PE BETONSCHUTZPLATTEN/PP BETONSCHUTZPLATTEN
 PE CONCRETE PROTECTIVE LINERS
 PE 80 / PEHD BLAU HYDRO+ UND HYDROCLICK
 PE 80 / HDPE BLUE HYDRO+ AND HYDROCLICK
 PEHD BIONIC SCS BETONSCHUTZPLATTEN
 HDPE BIONIC SCS CONCRETE PROTECTIVE LINERS
 PE 100-EL ESD BETONSCHUTZPLATTEN
 PE 100-EL ESD CONCRETE PROTECTIVE LINERS
 PVD-F-FLEX BETONSCHUTZPLATTEN
 PVD-F-FLEX CONCRETE PROTECTIVE LINERS
 ECTFE BETONSCHUTZPLATTEN
 ECTFE CONCRETE PROTECTIVE LINERS
 INDUKTOFIX
 INDUKTOFIX
 SCHWEISSDRAHT
 WELDING-ROD

HYDROCLICK Platte

für Trinkwasseranwendung mit AGRU Schutzfolie
extrudiert

Extrusionsschweissung
PE 80 blau RAL5012

HYDROCLICK Sheet

for potable water supply with AGRU protection foil
extruded

Extrusion-welding
PE 80 blue RAL5012

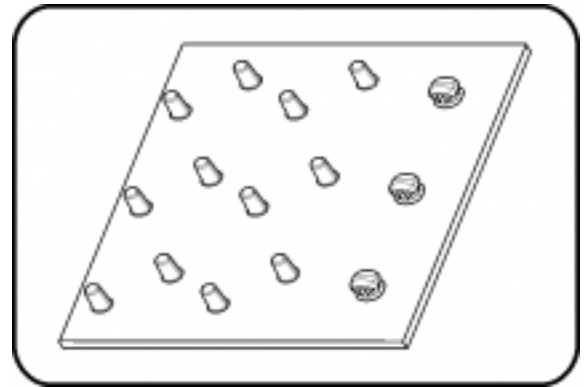

Code: 574

Dimension Dimension	Code Code	Detail Detail	b mm	thick mm	Lm m	Gewicht Weight
4	86.574.4020.40	4000X2000X4,0	2000	4	4	4,60

HYDROCLICK Platte gerollt

für Trinkwasseranwendung mit AGRU Schutzfolie
extrudiert

Extrusionsschweissung
PE 80 blau RAL5012

HYDROCLICK Sheet rolled

for potable water supply with AGRU protection foil
extruded

Extrusion-welding
PE 80 blue RAL5012

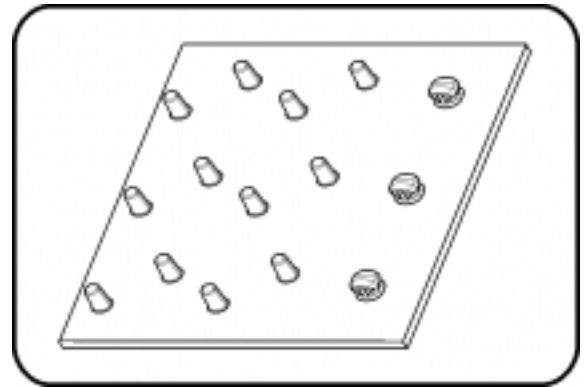

Code: 574

Dimension Dimension	Code Code	Detail Detail	b mm	thick mm	Lm m	Gewicht Weight
4	86.574.5020.40	5000X2000X4,0	1.995	4	50	4,60

HYDROCLICK Profil

Montagehilfe mit PE-el Prüfstreifen
co-extrudiert

Extrusionsschweissung
PE 100-RC schwarz

HYDROCLICK Profile

Installation accessory with PE-el test strip
co-extruded

Extrusion-welding
PE 100-RC black

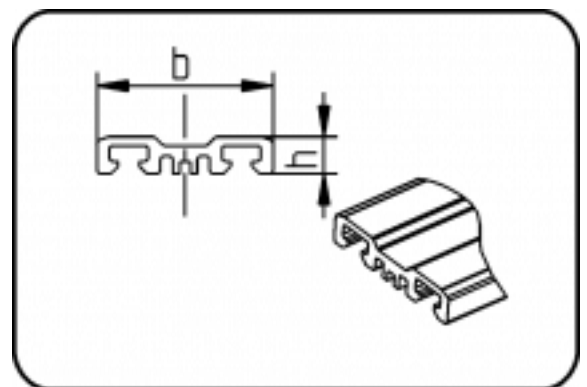

Code: 579

Dimension Dimension	Code Code	Detail Detail	h mm	b mm	Gewicht Weight
4000X50X10	70.579.0000.40	4000X50X10mm	10	50	0,25

HYDROCLICK Profil einseitig

Montagehilfe

mechanisch gefertigt

Extrusionsschweissung

PE 100 / PE 100-RC schwarz

HYDROCLICK Profile one sided

Installation accessory

machined

Extrusion-welding

PE 100 / PE 100-RC black

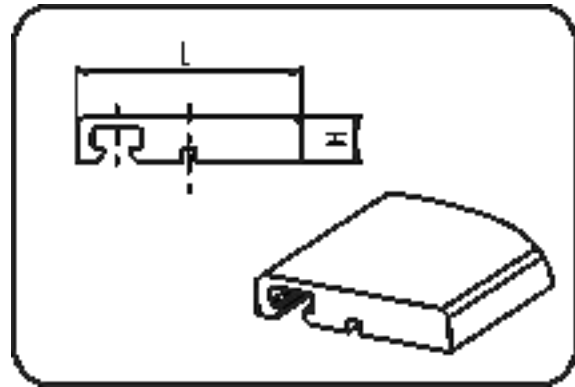

Code: 579.1

Dimension Dimension	Code Code	Detail Detail	h mm	b mm	Gewicht Weight
2000X50X10	70.579.1020.40	2000X50X10mm	10	50	0,40

Betonanker

Befestigungsmittel

formgespritzt

PE 80 blau RAL5012

Concrete anchor

Mounting accessory

injection moulded

PE 80 blue RAL5012

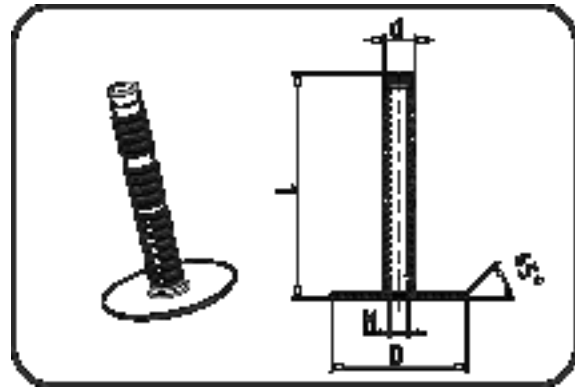

Code: 582

Dimension Dimension	Code Code	Detail Detail	d mm	d1 mm	d2 mm	L mm	Gewicht Weight
200mm M16	86.582.0200.16	200mm M16	120	16	25	200	0,12
150mm M16	86.582.0150.16	150mm M16	120	16	25	150	0,10
200mm M12	86.582.0200.12	200mm M12	120	12	25	200	0,14
150mm M12	86.582.0150.12	150mm M12	120	12	25	150	0,11

PE BETONSCHUTZPLATTEN
 PP CONCRETE
 PROTECTIVE LINERS
 PE BETONSCHUTZPLATTEN
 PE CONCRETE
 PROTECTIVE LINERS
 PE 80 / PEHD BLAU
 HYDRO+ UND HYDROCLICK
 PE 80 / HDPE BLUE
 HYDRO+ AND HYDROCLICK
 PEHD BIONIC SCS BETONSC
 HUTZPLATTEN
 HDPE BIONIC SCS CONCRETE
 PROTECTIVE LINERS
 PE 100-EL ESD
 BETONSCHUTZPLATTEN
 PE 100-EL ESD CONCRETE
 PROTECTIVE LINERS
 ECTFE BETONSCHUTZPLATTE
 N
 ECTFE CONCRETE
 PROTECTIVE LINERS
 INDUKTOFIX
 INDUKTOFIX
 SCHWEISSDRAHT
 WELDING-ROD

Platte KTW/EN16421

für Trinkwasseranwendung

extrudiert

mit einseitiger Schutzfolie

PEHD blau RAL5012

Sheet KTW/EN16421

for potable water supply

extruded

protective foil on one side

HDPE blue RAL5012

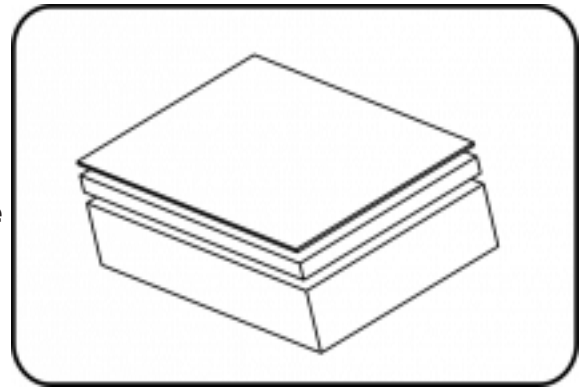

Code: 600

Dimension Dimension	Code Code	Detail Detail	L mm	b mm	thick mm	Gewicht Weight
5	86.600.4020.05	4000X2000X5	4.000	2000	5	38,10
8	86.600.4020.08	4000X2000X8	4.000	2.000	8	60,90
10	86.600.4020.10	4000X2000X10	4.000	2000	10	76,10
12	86.600.4020.12	4000X2000X12	4.000	2000	12	91,40
15	86.600.4020.15	4000X2000X15	4.000	2000	15	114,00
20	86.600.4020.20	4000X2000X20	4.000	2000	20	152,00
30	86.600.4020.30	4000X2000X30	4.000	2000	30	228,00

PE BETONSCHUTZPLATTENPP BETONSCHUTZPLATTEN
 PP CONCRETE
 PROTECTIVE LINERS
 PE 80 / PEHD BLAU
 HYDRO+ UND HYDROCLICK
 PE 80 / HDPE BLUE
 HYDRO+ AND HYDROCLICK
 PEHD BIONIC SCS BETONSC
 HUTZPLATTEN
 HDPE BIONIC SCS CONCRETE
 PROTECTIVE LINERS
 PE 100-EL ESD
 BETONSCHUTZPLATTEN
 PE 100-EL ESD CONCRETE
 PROTECTIVE LINERS
 PVDF-FLEX BETONSCHUTZPL
 ATTEN
 PVDF-FLEX CONCRETE
 PROTECTIVE LINERS
 ECTFE BETONSCHUTZPLATTE
 N
 ECTFE CONCRETE
 PROTECTIVE LINERS
 INDUKTOFIX
 INDUKTOFIX
 SCHWEISSDRAHT
 WELDING-ROD

PEHD BIONIC SCS BETONSCHUTZPLATTEN
HDPE BIONIC SCS CONCRETE PROTECTIVE LINERS

BETONSCHUTZPLATTEN
CONCRETE PROTECTIVE LINERS

Seite
 page

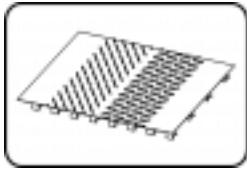

Code: 564

Sure Grip SelfCleaningSystem

Bionic Oberfläche 0,58m
 extrudiert
 PE gelb RAL1003

Sure Grip SelfCleaningSystem

Bionic Surface 0.58m
 extruded
 PE yellow RAL1003

35

SCHWEISSDRAHT WELDING-ROD	INDUKTOFIX INDUKTOFIX	ECTFE BETONSCHUTZPLATTE N ECTFE CONCRETE PROTECTIVE LINERS	PVDF-FLEX BETONSCHUTZPLATTEN ATTEN PVDF-FLEX CONCRETE PROTECTIVE LINERS	PE 100-EL ESD BETONSCHUTZPLATTEN PE 100-EL ESD CONCRETE PROTECTIVE LINERS	PEHD BIONIC SCS BETONSCHUTZPLATTEN HUTZPLATTEN HDPE BIONIC SCS CONCRETE PROTECTIVE LINERS	PE 80 / PEHD BLAU HYDRO+ UND HYDROCLICK PE 80 / HDPE BLUE HYDRO+ AND HYDROCLICK	PE BETONSCHUTZPLATTEN PE CONCRETE PE CONCRETE PROTECTIVE LINERS	PE BETONSCHUTZPLATTEN PP BETONSCHUTZPLATTEN PP CONCRETE PP CONCRETE PROTECTIVE LINERS
------------------------------	--------------------------	---	--	--	---	--	--	---



PEHD BIONIC SCS BETONSCHUTZPLATTEN
 HDPE BIONIC SCS CONCRETE PROTECTIVE LINERS

SCHWEISSDRAHT WELDING-ROD	INDUKTOFIX INDUKTOFIX	ECTFE BETONSCHUTZPLATTE N ECTFE CONCRETE PROTECTIVE LINERS	PVDF-FLEX BETONSCHUTZPLATTEN ATTEN PVDF-FLEX CONCRETE PROTECTIVE LINERS	PE 100-EL ESD BETONSCHUTZPLATTEN PE 100-EL ESD CONCRETE PROTECTIVE LINERS	PEHD BIONIC SCS BETONSCHUTZPLATTEN HDPE BIONIC SCS CONCRETE PROTECTIVE LINERS	PE 80 / PEHD BLAU HYDRO+ UND HYDROCLICK PE 80 / HDPE BLUE HYDRO+ AND HYDROCLICK	PE BETONSCHUTZPLATTEN PE CONCRETE PROTECTIVE LINERS	PP BETONSCHUTZPLATTEN PP CONCRETE PROTECTIVE LINERS
------------------------------	--------------------------	---	--	--	--	--	---	---

**Sure Grip
SelfCleaningSystem**

Bionic Oberfläche 0,58m
Noppen 13mm

extrudiert

Extrusionsschweissung

PE gelb RAL1003

**Sure Grip
SelfCleaningSystem**

Bionic Surface 0.58m
studs 13mm

extruded

Extrusion-welding

PE yellow RAL1003

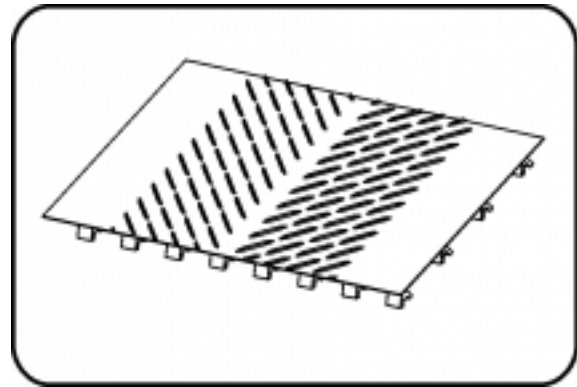

Code: 564

Dimension Dimension	Code Code	Detail Detail	L mm	b mm	thick mm	Nh mm	Gewicht Weight
2,0	21.564.2510.20	25000X1000X2,0	25.000	1.000	2	13	2,90
2,5	21.564.2510.25	25000X1000X2,5	25.000	1.000	2,5	13	3,40
3,0	21.564.2510.30	25000X1000X3,0	25.000	1.000	3	13	3,90

Keine Lagerware.
Not available from stock.

PEHD BIONIC SCS BETONSCHUTZPLATTEN
 HDPE BIONIC SCS CONCRETE PROTECTIVE LINERS
 PE 80 / PEHD BLAU HYDRO+
 UND HYDROCLICK
 HDPE BLUE HYDRO+
 AND HYDROCLICK
 PE 100-EL ESD
 BETONSCHUTZPLATTEN
 PE 100-EL ESD CONCRETE
 PROTECTIVE LINERS
 PVDF-FLEX BETONSCHUTZPLATTEN
 PVDF-FLEX CONCRETE
 PROTECTIVE LINERS
 ECTFE BETONSCHUTZPLATTEN
 ECTFE CONCRETE
 PROTECTIVE LINERS
 INDUKTOFIX
 INDUKTOFIX
 SCHWEISSDRAHT
 WELDING-ROD



PEHD BIONIC SCS BETONSCHUTZPLATTEN
 HDPE BIONIC SCS CONCRETE PROTECTIVE LINERS

SCHWEISSDRAHT WELDING-ROD	INDUKTOFIX INDUKTOFIX	ECTFE BETONSCHUTZPLATTE N ECTFE CONCRETE PROTECTIVE LINERS	PVDF-FLEX BETONSCHUTZPLATTEN ATTEN PVDF-FLEX CONCRETE PROTECTIVE LINERS	PE 100-EL ESD BETONSCHUTZPLATTEN PE 100-EL ESD CONCRETE PROTECTIVE LINERS	PEHD BIONIC SCS BETONSCHUTZPLATTEN HDPE BIONIC SCS CONCRETE PROTECTIVE LINERS	PE 80 / PEHD BLAU HYDRO+ UND HYDROCLICK PE 80 / HDPE BLUE HYDRO+ AND HYDROCLICK	PE BETONSCHUTZPLATTEN PE CONCRETE PROTECTIVE LINERS	PP BETONSCHUTZPLATTEN PP CONCRETE PROTECTIVE LINERS
------------------------------	--------------------------	---	--	--	--	--	---	---

PE 100-EL ESD BETONSCHUTZPLATTEN
PE 100-EL ESD CONCRETE PROTECTIVE LINERS

BETONSCHUTZPLATTEN
CONCRETE PROTECTIVE LINERS

Seite
page

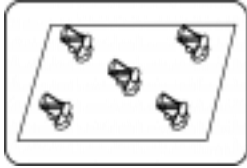

Code: 562

AGRU-Ultra Grip BSP
Noppen 13mm - 4000X2000mm
extrudiert
PE 100-el schwarz

AGRU-Ultra Grip CPL
studs 13mm - 4000X2000mm
extruded
PE 100-el black

41

SCHWEISSDRAHT WELDING-ROD	INDUKTOFIX INDUKTOFIX	ECTFE BETONSCHUTZPLATTE N ECTFE CONCRETE PROTECTIVE LINERS	PVDF-FLEX BETONSCHUTZPLATTEN ATTEN PVDF-FLEX CONCRETE PROTECTIVE LINERS	PE 100-EL ESD BETONSCHUTZPLATTEN UTZPLATTEN PE 100-EL ESD CONCRETE PROTECTIVE LINERS	PEHD BIONIC SCS BETONSCHUTZPLATTEN UTZPLATTEN HDPE BIONIC SCS CONCRETE PROTECTIVE LINERS	PEHD BLAU HYDRO+ UND HYDROCLICK PE 80 / HDPE BLUE HYDRO+ AND HYDROCLICK	PE BETONSCHUTZPLATTEN PP PE CONCRETE PROTECTIVE LINERS	PE BETONSCHUTZPLATTEN PP PE CONCRETE PROTECTIVE LINERS
------------------------------	--------------------------	---	--	---	---	--	---	---



PE 100-EL ESD BETONSCHUTZPLATTEN
 PE 100-EL ESD CONCRETE PROTECTIVE LINERS

SCHWEISSDRAHT WELDING-ROD	INDUKTOFIX INDUKTOFIX	ECTFE BETONSCHUTZPLATTEN ECTFE CONCRETE PROTECTIVE LINERS	PVDF-FLEX BETONSCHUTZPLATTEN PVD-FLEX CONCRETE PROTECTIVE LINERS	PE 100-EL ESD BETONSCHUTZPLATTEN UTZPLATTEN PE 100-EL ESD CONCRETE PROTECTIVE LINERS	HDPE BIONIC SCS CONCRETE PROTECTIVE LINERS HDPE BIONIC SCS CONCRETE PROTECTIVE LINERS	PE 80 / PEHD BLAU HYDRO+ UND HYDROCLICK PE 80 / HDPE BLUE HYDRO+ AND HYDROCLICK	PE BETONSCHUTZPLATTEN PE CONCRETE PROTECTIVE LINERS	PP BETONSCHUTZPLATTEN PP CONCRETE PROTECTIVE LINERS
------------------------------	--------------------------	--	---	---	--	--	--	--

AGRU-Ultra Grip BSP

Noppen 13mm - 4000X2000mm

extrudiert

Extrusionsschweissung

PE 100-el schwarz

AGRU-Ultra Grip CPL

studs 13mm - 4000X2000mm

extruded

Extrusion-welding

PE 100-el black

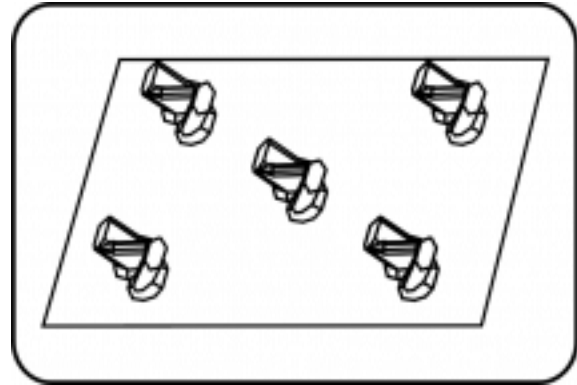

Code: 562

Dimension Dimension	Code Code	Detail Detail	b mm	thick mm	Nh mm	Lm m	Gewicht Weight
3,0	28.562.4020.30	4000X2000X3,0	2.000	3	13	4	4,20
5,0	28.562.4020.50	4000X2000X5,0	2.000	5	13	4	6,20

SCHWEISSDRAHT
WELDING-ROD
INDUKTOFIX
INDUKTOFIX
ECTFE BETONSCHUTZPLATTE
N
ECTFE CONCRETE
PROTECTIVE LINERS
PVDf-FLEX BETONSCHUTZPLATTEN
ATTEN
PVDf-FLEX CONCRETE
PROTECTIVE LINERS
PE 100-EL ESD BETONSCHUTZPLATTEN
UTZPLATTEN
PE 100-EL ESD CONCRETE
PROTECTIVE LINERS
PEHD BIONIC SCS BETONSCHUTZPLATTEN
UTZPLATTEN
HDPE BIONIC SCS CONCRETE
PROTECTIVE LINERS
PEHD BLAU HYDRO+
UND HYDROCLICK
HDPE BLUE HYDRO+
AND HYDROCLICK
PE BETONSCHUTZPLATTEN
PP
PE CONCRETE
PROTECTIVE LINERS
BETONSCHUTZPLATTEN
PP
PP CONCRETE
PROTECTIVE LINERS



PE 100-EL ESD BETONSCHUTZPLATTEN
PE 100-EL ESD CONCRETE PROTECTIVE LINERS

SCHWEISSDRAHT WELDING-ROD	INDUKTOFIX INDUKTOFIX	ECTFE BETONSCHUTZPLATTEN ECTFE CONCRETE PROTECTIVE LINERS	PVDF-FLEX BETONSCHUTZPLATTEN PVD-FLEX CONCRETE PROTECTIVE LINERS	PE 100-EL ESD BETONSCHUTZPLATTEN UTZPLATTEN PE 100-EL ESD CONCRETE PROTECTIVE LINERS	HDPE BIONIC SCS CONCRETE PROTECTIVE LINERS HDPE BIONIC SCS CONCRETE PROTECTIVE LINERS	PE 80 / PEHD BLAU HYDRO+ UND HYDROCLICK PE 80 / HDPE BLUE HYDRO+ AND HYDROCLICK	PE BETONSCHUTZPLATTEN PE CONCRETE PROTECTIVE LINERS	PP BETONSCHUTZPLATTEN PP CONCRETE PROTECTIVE LINERS
------------------------------	--------------------------	--	---	---	--	--	--	--

PVDF-FLEX BETONSCHUTZPLATTEN
PVDF-FLEX CONCRETE PROTECTIVE LINERS

BETONSCHUTZPLATTEN
CONCRETE PROTECTIVE LINERS

Seite
page

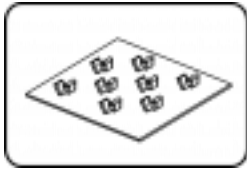

Code: 560

AGRU-Sure Grip BSP
Noppen 13mm - 3000X1500mm
extrudiert
PVDF-FLEX natur

AGRU-Sure Grip CPL
studs 13mm - 3000X1500mm
extruded
PVDF-FLEX natural

47

SCHWEISSDRAHT WELDING-ROD	INDUKTOFIX INDUKTOFIX	ECTFE BETONSCHUTZPLATTE N ECTFE CONCRETE PROTECTIVE LINERS	PVDF-FLEX BETONSCHUTZ PLATTEN PVDF-FLEX CONCRETE PROTECTIVE LINERS	PE 100-EL ESD BETONSCHUTZPLATTEN PE 100-EL ESD CONCRETE PROTECTIVE LINERS	PEHD BIONIC SCS BETONSCHU PEHD BIONIC SCS CONCRETE PROTECTIVE LINERS	PEHD BIONIC SCS BETONSCHUPE 80 / PEHD BLAU HYDRO+ PEHD BIONIC SCS CONCRETE PE 80 / HDPE BLUE HYDRO+ UND HYDROCLICK UND HYDROCLICK	PE BETONSCHUTZPLATTEN PE CONCRETE PROTECTIVE LINERS	PE BETONSCHUTZPLATTEN PE CONCRETE PROTECTIVE LINERS
------------------------------	--------------------------	---	---	--	--	--	---	---



PVDF-FLEX BETONSCHUTZPLATTEN
 PVDF-FLEX CONCRETE PROTECTIVE LINERS

SCHWEISSDRAHT WELDING-ROD	INDUKTOFIX INDUKTOFIX	ECTIFE BETONSCHUTZPLATTE N ECTIFE CONCRETE PROTECTIVE LINERS	PVDF-FLEX BETONSCHUTZ PLATTEN PVDF-FLEX CONCRETE PROTECTIVE LINERS	PE 100-EL ESD BETONSCHUTZPLATTEN PE 100-EL ESD CONCRETE PROTECTIVE LINERS	HDPE BIONIC SCS CONCRETE PE 80 / HDPE BLUE HYDRO-+ AND HYDROCLICK	PEHD BIONIC SCS BETONSCH UTZPLATTEN HDPE BIONIC SCS CONCRETE PE 80 / HDPE BLUE HYDRO-+ AND HYDROCLICK	PE BETONSCHUTZPLATTEN PE CONCRETE PROTECTIVE LINERS	PP BETONSCHUTZPLATTEN PP CONCRETE PROTECTIVE LINERS
------------------------------	--------------------------	---	---	--	---	---	---	---

AGRU-Sure Grip BSP

Noppen 13mm - 3000X1500mm

extrudiert

Extrusionsschweissung

PVDF-FLEX natur

AGRU-Sure Grip CPL

studs 13mm - 3000X1500mm

extruded

Extrusion-welding

PVDF-FLEX natural

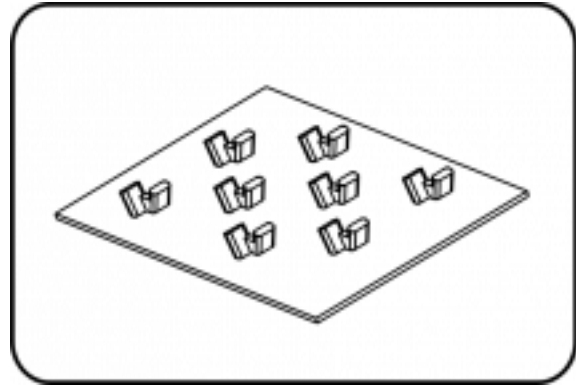

Code: 560

Dimension Dimension	Code Code	Detail Detail	L mm	b mm	thick mm	Nh mm	Gewicht Weight
4	79.560.3015.40	3000X1500X4,0	3.000	1.500	3	13	8,42

SCHWEISSDRAHT
WELDING-ROD
 INDUKTOFIX
INDUKTOFIX
 ECTFE BETONSCHUTZPLATTE
N
ECTFE CONCRETE
PROTECTIVE LINERS
 PVDF-FLEX BETONSCHUTZ
PLATTEN
PVDF-FLEX CONCRETE
PROTECTIVE LINERS
 PE 100-EL ESD
BETONSCHUTZPLATTEN
PE 100-EL ESD CONCRETE
PROTECTIVE LINERS
 PEHD BIONIC SCS BETONSCHUPE 80 / PEHD BLAU HYDRO+
UTZPLATTEN
UND HYDROCLICK
HDPE BIONIC SCS CONCRETE PE 80 / HDPE BLUE HYDRO+
AND HYDROCLICK
 PE BETONSCHUTZPLATTEN
PE CONCRETE
PROTECTIVE LINERS
 PP BETONSCHUTZPLATTEN
PP CONCRETE
PROTECTIVE LINERS



PVDF-FLEX BETONSCHUTZPLATTEN
 PVDF-FLEX CONCRETE PROTECTIVE LINERS

SCHWEISSDRAHT WELDING-ROD	INDUKTOFIX INDUKTOFIX	ECTFE BETONSCHUTZPLATTE N ECTFE CONCRETE PROTECTIVE LINERS	PVDF-FLEX BETONSCHUTZ PLATTEN PVDF-FLEX CONCRETE PROTECTIVE LINERS	PE 100-EL ESD BETONSCHUTZPLATTEN PE 100-EL ESD CONCRETE PROTECTIVE LINERS	HDPE BIONIC SCS CONCRETE PE 80 / HDPE BLUE HYDRO-+ AND HYDROCLICK	PEHD BIONIC SCS BETONSCH UTZPLATTEN HDPE BIONIC SCS CONCRETE PE 80 / HDPE BLUE HYDRO-+ AND HYDROCLICK	PE BETONSCHUTZPLATTEN PE CONCRETE PROTECTIVE LINERS	PE BETONSCHUTZPLATTEN PP CONCRETE PROTECTIVE LINERS
------------------------------	--------------------------	---	---	--	---	---	---	---

ECTFE BETONSCHUTZPLATTEN
ECTFE CONCRETE PROTECTIVE LINERS

BETONSCHUTZPLATTEN
CONCRETE PROTECTIVE LINERS

Seite
page

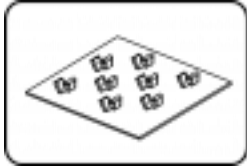

Code: 560

AGRU-Sure Grip BSP
Noppen 13mm - 3000X1000mm
extrudiert
ECTFE natur

AGRU-Sure Grip CPL
studs 13mm - 3000X1000mm
extruded
ECTFE natural

53

SCHWEISSDRAHT WELDING-ROD	INDUKTOFIX INDUKTOFIX	ECTFE BETONSCHUTZPLATTEN ECTFE CONCRETE PROTECTIVE LINERS	PVDF-FLEX BETONSCHUTZPLATTEN ATTEN PVDF-FLEX CONCRETE PROTECTIVE LINERS	PE 100-EL ESD BETONSCHUTZPLATTEN PE 100-EL ESD CONCRETE PROTECTIVE LINERS	PEHD BIONIC SCS BETONSCHUTZPLATTEN UTZPLATTEN HDPE BIONIC SCS CONCRETE PROTECTIVE LINERS	PEHD BLAU HYDRO+ UND HYDROCLICK PE 80 / HDPE BLUE HYDRO+ AND HYDROCLICK	PE BETONSCHUTZPLATTEN PE CONCRETE PROTECTIVE LINERS	PE BETONSCHUTZPLATTEN PE CONCRETE PROTECTIVE LINERS
------------------------------	--------------------------	--	---	--	--	--	--	--

SCHWEISSDRAHT
WELDING-ROD

INDUKTOFIX
INDUKTOFIX

**ECTIFE BETONSCHUTZPLATTEN
ECTFE CONCRETE
PROTECTIVE LINERS**

PVDF-FLEX BETONSCHUTZPLATTEN
ATTEN
PVDF-FLEX CONCRETE
PROTECTIVE LINERS

PE 100-EL ESD
BETONSCHUTZPLATTEN
PE 100-EL ESD CONCRETE
PROTECTIVE LINERS

PEHD BIONIC SCS BETONSCHUTZPLATTEN
HDPE BIONIC SCS CONCRETE
PROTECTIVE LINERS

PEHD BLAU HYDRO+
UND HYDROCLICK
PE 80 / HDPE BLUE HYDRO+
AND HYDROCLICK

PE BETONSCHUTZPLATTEN
PE CONCRETE
PROTECTIVE LINERS

PP BETONSCHUTZPLATTEN
PP CONCRETE
PROTECTIVE LINERS



AGRU-Sure Grip BSP

Noppen 13mm - 3000X1000mm

extrudiert

Extrusionsschweissung

ECTFE natur

AGRU-Sure Grip CPL

studs 13mm - 3000X1000mm

extruded

Extrusion-welding

ECTFE natural

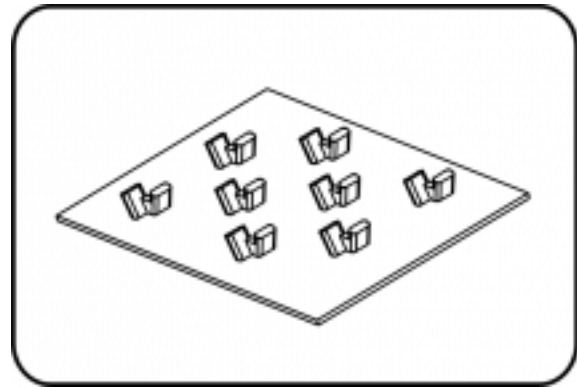

Code: 560

Dimension Dimension	Code Code	Detail Detail	L mm	b mm	thick mm	Nh mm	Gewicht Weight
2,5	40.560.3010.25	3000X1000X2,5	3.000	1.000	2,5	13	5,40

SCHWEISSDRAHT
WELDING-ROD

 INDUKTOFIX
INDUKTOFIX

 ECTFE BETONSCHUTZPLATTEN
ECTFE CONCRETE PROTECTIVE LINERS

 PVDF-FLEX CONCRETE PROTECTIVE LINERS

 PE 100-EL ESD BETONSCHUTZPLATTEN
PE 100-EL ESD CONCRETE PROTECTIVE LINERS

 PEHD BIONIC SCS BETONSCHUTZPLATTEN
PEHD BIONIC SCS CONCRETE PROTECTIVE LINERS

 PEHD BLAU HYDRO+ UND HYDROCLICK
HDPE BLUE HYDRO+ AND HYDROCLICK

 PE BETONSCHUTZPLATTEN
PE CONCRETE PROTECTIVE LINERS

 PP BETONSCHUTZPLATTEN
PP CONCRETE PROTECTIVE LINERS

SCHWEISSDRAHT
WELDING-ROD

INDUKTOFIX
INDUKTOFIX

**ECTIFE BETONSCHUTZPLATTEN
ECTFE CONCRETE
PROTECTIVE LINERS**

**PVDF-FLEX BETONSCHUTZPLATTEN
ATTEN
PVDF-FLEX CONCRETE
PROTECTIVE LINERS**

**PE 100-EL ESD
BETONSCHUTZPLATTEN
PE 100-EL ESD CONCRETE
PROTECTIVE LINERS**

**PEHD BIONIC SCS BETONSCHUTZPLATTEN
HDPE BIONIC SCS CONCRETE
PROTECTIVE LINERS**

**PEHD BLAU HYDRO+
UND HYDROCLICK
PE 80 / HDPE BLUE HYDRO+
AND HYDROCLICK**

**PE BETONSCHUTZPLATTEN
PE CONCRETE
PROTECTIVE LINERS**

**PP BETONSCHUTZPLATTEN
PP CONCRETE
PROTECTIVE LINERS**



**ECTFE BETONSCHUTZPLATTEN
ECTFE CONCRETE PROTECTIVE LINERS**

INDUKTOFIX

INDUKTOFIX

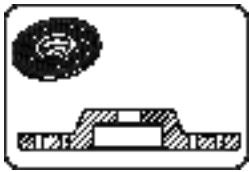
RONDELLEN**DISCS****Seite****page**

Code: 039.4

BSP Induktofix Rondelle

Befestigungsmittel
formgespritzt
PEHD schwarz

CPL Induktofix Disc

Mounting accessory
injection moulded
HDPE black

59

Code: 039.5

Hydroclick Induktofix Rondelle

Befestigungsmittel
formgespritzt
PE 80 blau RAL5012

Hydroclick Induktofix Disc

Mounting accessory
injection moulded
PE 80 blue RAL5012

59**SCHWEISSTECHNIK****WELDING TECHNOLOGY****Seite****page**

Code: INDU0010

Induktofix IW 2000

Rondellen: BSP,DB,HydroClick

Induktofix IW 2000

Disc: CPL,Liner,HydroClick

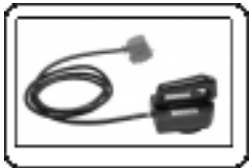
60

Code: GINDUF

Flachinduktor

für Induktofix Rondellen

Flat inductor

for Induktofix discs

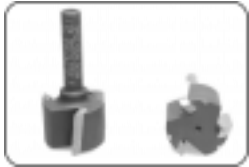
60

Code: FPF03

Fräser Sonderplan HM

Betonschutzplattenfräser

Special carbide cutter plan HM

Concrete prot. liner milling

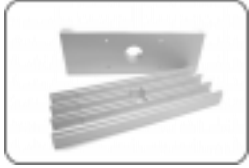
60

Code: FPF01

Führungsplatte für Fräse

für Fräsung

Guide plate

for milling

Betonschutzplatte

Concrete protective liner

61

Code: FPF02

Führungsplatte für Fräse

für Fräsung quer

Guide plate

for milling transversal

Betonschutzplatte

Concrete protective liner

61

Code: 110315.S1

Etikettendrucker (TTP)

Farbe beige

Label Printer (TTP)

Color beige

SP-Serie

SP-Series

61

SCHWEISSDRAHT
WELDING-ROD

INDUKTOFIX
INDUKTOFIX

ECTFE BETONSCHUTZPLATTE N ECTFE CONCRETE PROTECTIVE LINERS	PVDF-FLEX BETONSCHUTZPLATTEN ATTEN PVDF-FLEX CONCRETE PROTECTIVE LINERS	PE 100-EL ESD BETONSCHUTZPLATTEN PE 100-EL ESD CONCRETE PROTECTIVE LINERS	PEHD BIONIC SCS BETONSCHUTZPLATTEN UTZPLATTEN HDPE BIONIC SCS CONCRETE PROTECTIVE LINERS	PEHD BLAU HYDRO+ UND HYDROCLICK PE 80 / HDPE BLUE HYDRO+ AND HYDROCLICK	PE BETONSCHUTZPLATTEN PE CONCRETE PROTECTIVE LINERS	PP BETONSCHUTZPLATTEN PP CONCRETE PROTECTIVE LINERS
---	--	--	---	--	---	---



INDUKTOFIX

INDUKTOFIX

BSP Induktofix Rondelle

Befestigungsmittel
70/40 großes Gitter
formgespritzt

Induktionsschweissung

PEHD schwarz

CPL Induktofix Disc

Mounting accessory
70/40 large grid
injection moulded

Induction welding

HDPE black

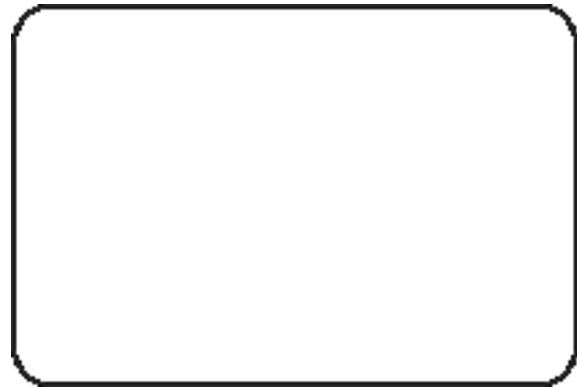

Code: 039.4

Dimension Dimension	Code Code	Detail Detail	d mm	d1 mm	d2 mm	h mm	Gewicht Weight
80	27.039.4070.40	80/32	80	8	25	14,5	0,03

Hydroclick Induktofix Rondelle

Befestigungsmittel
4,5mm Loch
formgespritzt

Induktionsschweissung

PE 80 blau RAL5012

Hydroclick Induktofix Disc

Mounting accessory
4.5mm hole
injection moulded

Induction welding

PE 80 blue RAL5012

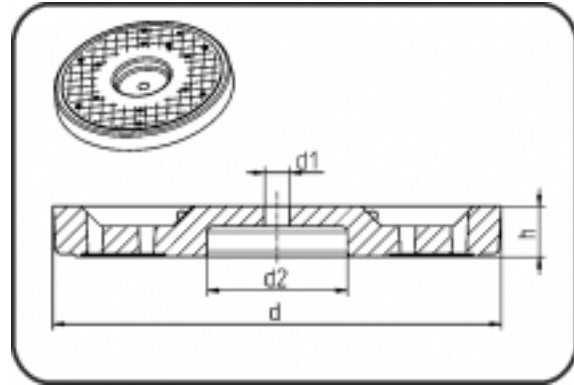

Code: 039.5

Dimension Dimension	Code Code	Detail Detail	d mm	d1 mm	d2 mm	h mm	Gewicht Weight
80	86.039.5080.25	80/25	80	4,5	25	9	0,03

INDUKTOFIX
INDUKTOFIX
SCHWEISSDRAHT
WELDING-ROD
ECTFE BETONSCHUTZPLATTE
N
ECTFE CONCRETE
PROTECTIVE LINERS
PVDF-FLEX BETONSCHUTZPL
ATTEN
PVDF-FLEX CONCRETE
PROTECTIVE LINERS
PE 100-EL ESD
BETONSCHUTZPLATTEN
PE 100-EL ESD CONCRETE
PROTECTIVE LINERS
PEHD BIONIC SCS BETONSCHEIPE 80 / PEHD BLAU HYDRO+
UND HYDROCLICK
HDPE BIONIC SCS CONCRETE PE 80 / HDPE BLUE HYDRO+
AND HYDROCLICK
PE BETONSCHUTZPLATTEN
PE CONCRETE
PROTECTIVE LINERS
PP BETONSCHUTZPLATTEN
PP CONCRETE
PROTECTIVE LINERS

Induktofix IW 2000

Rondellen: BSP,DB,HydroClick
Induktions-E-Muffe: Poly-Flo

Induktofix IW 2000

Disc: CPL,Liner,HydroClick
Induction E-Coupler: Poly-Flo



Code: INDU0010

Dimension Dimension	Code Code	Detail Detail	Gewicht Weight
	SAGINDU0010		30,00

Ohne Zubehör.
Without accessories.

Flachinduktor

für Induktofix Rondellen

Flat inductor

for Induktofix discs

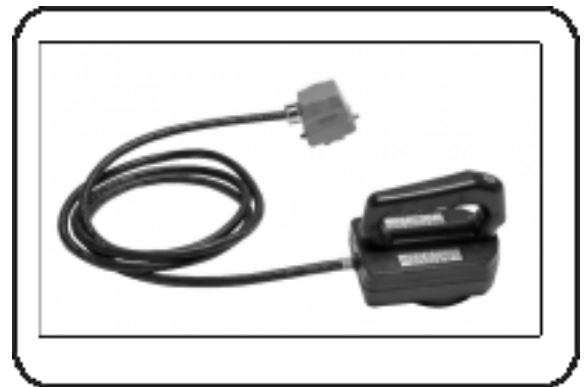

Code: GINDUF

Dimension Dimension	Code Code	Detail Detail	Gewicht Weight
	SAGINDUF010		0,90

Fräser Sonderplan HM

Betonschutzplattenfräser

**Special carbide cutter
plan HM**

Concrete prot. liner milling

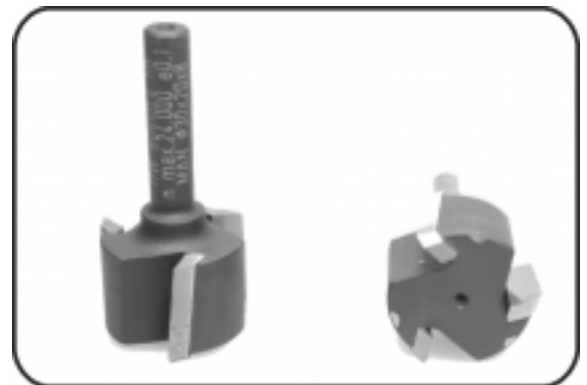

Code: FPF03

Dimension Dimension	Code Code	Detail Detail	Gewicht Weight
	WZFPFBSP003		0,09

PE BETONSCHUTZPLATTEN
PP CONCRETE
PROTECTIVE LINERS

PEHD BIONIC SCS BETONSCHUTZPLATTEN
UND HYDROCLICK
HDPE BIONIC SCS CONCRETE
AND HYDROCLICK

PE 100-EL ESD
BETONSCHUTZPLATTEN
PE 100-EL ESD CONCRETE
PROTECTIVE LINERS

PVDF-FLEX BETONSCHUTZPLATTEN
ATTEN
PVDF-FLEX CONCRETE
PROTECTIVE LINERS

ECTFE BETONSCHUTZPLATTEN
N
ECTFE CONCRETE
PROTECTIVE LINERS

INDUKTOFIX
INDUKTOFIX

SCHWEISSDRAHT
WELDING-ROD

Führungsplatte für Fräse

Guide plate

für Fräsung
in Extrusionsrichtung

for milling
in extrusion direction

Betonschutzplatte

Concrete protective liner

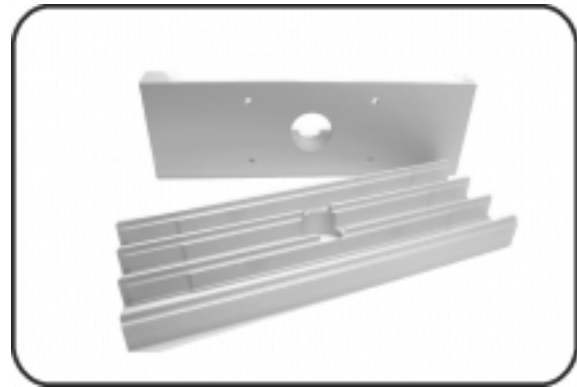

Code: FFP01

Dimension Dimension	Code Code	Detail Detail	Gewicht Weight
	WZFPPFBSP001		0,86

Führungsplatte für Fräse

Guide plate

für Fräsung quer
zur Extrusionsrichtung

for milling transversal
to extrusion direction

Betonschutzplatte

Concrete protective liner

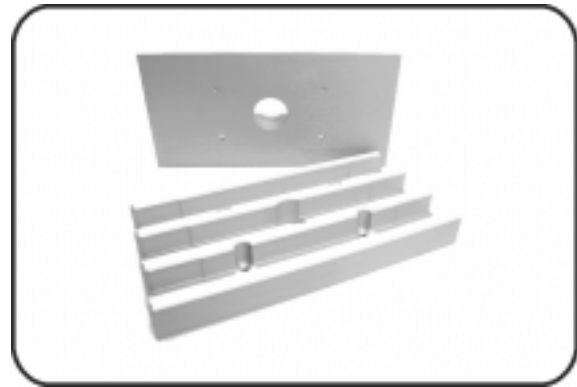

Code: FFP02

Dimension Dimension	Code Code	Detail Detail	Gewicht Weight
	WZFPPFBSP002		1,34

Etikettendrucker (TTP)

Label Printer (TTP)

Farbe beige

Color beige

SP-Serie

SP-Series



Code: 110315.S1

Dimension Dimension	Code Code	Detail Detail	Gewicht Weight
	SAG110315S1		3,65

SCHWEISSDRAHT
WELDING-ROD

INDUKTOFIX
INDUKTOFIX

ECTFE BETONSCHUTZPLATTE
N
ECTFE CONCRETE
PROTECTIVE LINERS

PVDF-FLEX BETONSCHUTZPL
ATTEN
PVDF-FLEX CONCRETE
PROTECTIVE LINERS

PE 100-EL ESD
BETONSCHUTZPLATTEN
PE 100-EL ESD CONCRETE
PROTECTIVE LINERS

PEHD BIONIC SCS BETONSCH
UTZPLATTEN
HDPE BIONIC SCS CONCRETE
PROTECTIVE LINERS

PEHD BLAU HYDRO+
UND HYDROCLICK
PE 80 / HDPE BLUE HYDRO+
AND HYDROCLICK

PE BETONSCHUTZPLATTEN
PE CONCRETE
PROTECTIVE LINERS

PP BETONSCHUTZPLATTEN
PP CONCRETE
PROTECTIVE LINERS





INDUKTOFIX
INDUKTOFIX

SCHWEISSDRAHT

WELDING-ROD

SCHWEISSDRAHT
WELDING-ROD

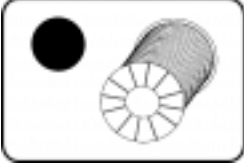
Seite
page

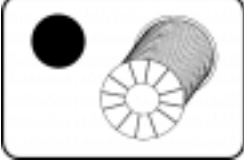
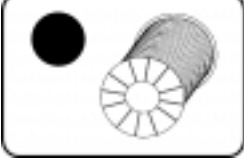
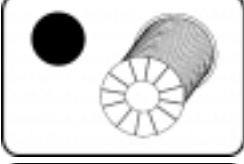
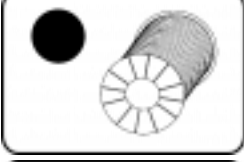
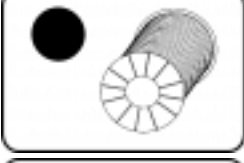
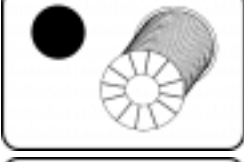
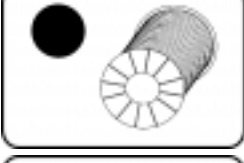
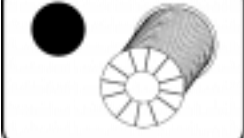
	Code: 11.410 Schweisdraht 3kg Rolle Kreis-Querschnitt extrudiert PPR grau	Welding-Rod 3kg roll circular profile extruded PPR grey	67
	Code: 14.410 Schweisdraht 3kg Rolle Kreis-Querschnitt extrudiert PP schwarz	Welding-Rod 3kg roll circular profile extruded PP black	67
	Code: 27.410 Schweisdraht 3kg Rolle Kreis-Querschnitt extrudiert PEHD schwarz	Welding-Rod 3kg roll circular profile extruded HDPE black	68
	Code: 86.410 Schweisdraht 3kg Rolle Kreis-Querschnitt extrudiert PE 80 blau RAL5012	Welding-Rod 3kg roll circular profile extruded PE 80 blue RAL5012	68
	Code: 21.410 Schweisdraht 3kg Rolle Kreis-Querschnitt extrudiert PE gelb RAL1003	Welding-Rod 3kg roll circular profile extruded PE yellow RAL1003	69
	Code: 56.410 Schweisdraht 3kg Rolle Kreis-Querschnitt extrudiert PE achatgrau RAL7038	Welding-Rod 3kg roll circular profile extruded PE agate grey RAL7038	69
	Code: 28.410 Schweisdraht 3kg Rolle Kreis-Querschnitt extrudiert PE 100-el schwarz	Welding-Rod 3kg roll circular profile extruded PE 100-el black	69
	Code: 79.410 Schweisdraht 2kg Rolle Kreis-Querschnitt extrudiert PVDF-FLEX natur	Welding-Rod 2kg roll circular profile extruded PVDF-FLEX natural	70
	Code: 40.410 Schweisdraht 2kg Rolle Kreis-Querschnitt extrudiert ECTFE natur	Welding-Rod 2kg roll circular profile extruded ECTFE natural	70
	Code: 76.410 Reinigungsdraht f.Schweissext. Kreis-Querschnitt / 2kg Rolle extrudiert Sonderpolymer	Purging rod for Extrusion Gun circular profile / 2kg roll extruded Special Polymer	70

BETONSCHUTZPLATTEN
 PP CONCRETE
 PROTECTIVE LINERS
 PE BETONSCHUTZPLATTEN
 PE CONCRETE
 PROTECTIVE LINERS
 PEHD BIONIC SCS BETONSC
 HIPE 80 / PEHD BLAU HYDRO+
 UND HYDROCLICK
 HDPE BIONIC SCS CONCRETE
 PE 80 / HDPE BLUE HYDRO+
 AND HYDROCLICK
 PROTECTIVE LINERS
 PE 100-EL ESD
 BETONSCHUTZPLATTEN
 PE 100-EL ESD CONCRETE
 PROTECTIVE LINERS
 ECTFE BETONSCHUTZPLATTE
 PVDF-FLEX CONCRETE
 PROTECTIVE LINERS
 ECTFE CONCRETE
 PROTECTIVE LINERS
 INDUKTOFIX
 INDUKTOFIX
 SCHWEISSDRAHT
 WELDING-ROD

INDUKTOFIX
INDUKTOFIX

ECTFE BETONSCHUTZPLATTE
N
ECTFE CONCRETE
PROTECTIVE LINERS

PVDF-FLEX BETONSCHUTZPL
ATTEN
PVDF-FLEX CONCRETE
PROTECTIVE LINERS

PE 100-EL ESD
BETONSCHUTZPLATTEN
PE 100-EL ESD CONCRETE
PROTECTIVE LINERS

PEHD BIONIC SCS BETONSCH
UTZPLATTEN
HDPE BIONIC SCS CONCRETE
PROTECTIVE LINERS

PEHD BLAU HYDRO+
UND HYDROCLICK
PE 80 / HDPE BLUE HYDRO+
AND HYDROCLICK

PE BETONSCHUTZPLATTEN
PE CONCRETE
PROTECTIVE LINERS

PP BETONSCHUTZPLATTEN
PP CONCRETE
PROTECTIVE LINERS



Schweisdraht 3kg Rolle Welding-Rod 3kg roll

Kreis-Querschnitt

circular profile

extrudiert

extruded

**Warmgas-
Ziehschweissung**

Hot-gas-welding

PPR grau

PPR grey

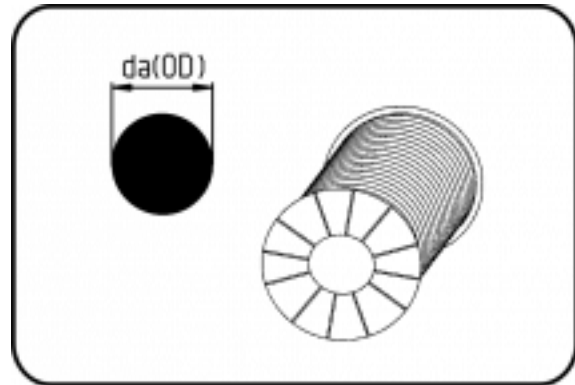

Code: 11.410

Dimension Dimension	Code Code	Detail Detail	da(OD) mm	Gewicht Weight
3	11.410.0000.30	3mm x min. 396m	3	1,00
4	11.410.0000.40	4mm x min. 230m	4	1,00
5	11.410.0000.50	5mm x min. 144m	5	1,00

Schweisdraht 3kg Rolle Welding-Rod 3kg roll

Kreis-Querschnitt

circular profile

extrudiert

extruded

**Warmgas-
Ziehschweissung**

Hot-gas-welding

PP schwarz

PP black

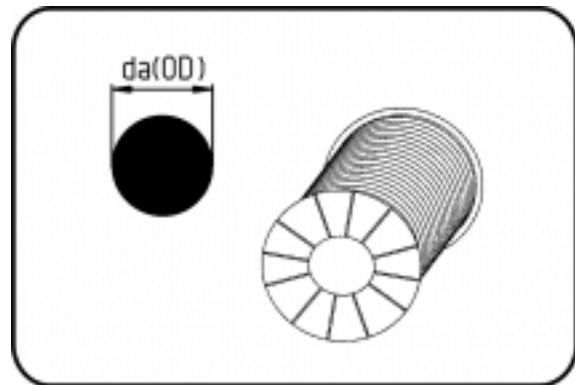

Code: 14.410

Dimension Dimension	Code Code	Detail Detail	da(OD) mm	Gewicht Weight
4	14.410.0000.40	4mm x min. 230m	4	1,00

BETONSCHUTZPLATTEN
PP CONCRETE
PROTECTIVE LINERS

BETONSCHUTZPLATTEN
PE CONCRETE
PROTECTIVE LINERS

PEHD BIONIC SCS BETONSCHUPE 80 / PEHD BLAU HYDRO+
UND HYDROCLICK
PE CONCRETE
AND HYDROCLICK

HDPE BIONIC SCS CONCRETE PE 80 / HDPE BLUE HYDRO+
PROTECTIVE LINERS
AND HYDROCLICK

PE 100-EL ESD
BETONSCHUTZPLATTEN
PE 100-EL ESD CONCRETE
PROTECTIVE LINERS

PE 100-EL ESD
BETONSCHUTZPLATTEN
PE 100-EL ESD CONCRETE
PROTECTIVE LINERS

ECTFE BETONSCHUTZPLATTE
N
ECTFE CONCRETE
PROTECTIVE LINERS

INDUKTOFIX
INDUKTOFIX

SCHWEISSDRAHT
WELDING-ROD

Schweisdraht 3kg Rolle

Welding-Rod 3kg roll

Kreis-Querschnitt

circular profile

extrudiert

extruded

Extrusionsschweissung

Extrusion-welding

PEHD schwarz

HDPE black

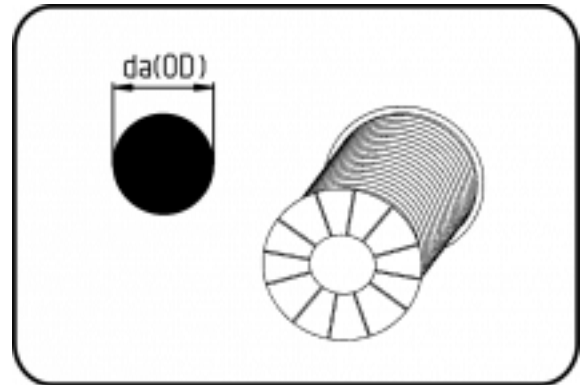

Code: 27.410

Dimension Dimension	Code Code	Detail Detail	da(OD) mm	Gewicht Weight
3	27.410.0000.30	3mm x min. 380m	3	1,00
4	27.410.0000.40	4mm x min. 220m	4	1,00
5	27.410.0000.50	5mm x min. 138m	5	1,00

Schweisdraht 3kg Rolle

Welding-Rod 3kg roll

Kreis-Querschnitt

circular profile

extrudiert

extruded

**Warmgas-
Zihschweissung**

Hot-gas-welding

PE 80 blau RAL5012

PE 80 blue RAL5012

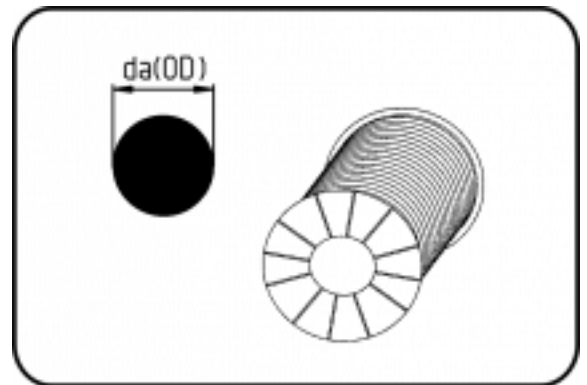

Code: 86.410

Dimension Dimension	Code Code	Detail Detail	da(OD) mm	Gewicht Weight
3	86.410.0000.30	3mm x min. 380m	3	1,00
4	86.410.0000.40	4mm x min. 220m	4	1,00

PE BETONSCHUTZPLATTENPP
 BETONSCHUTZPLATTENPP
 PP CONCRETE
 PROTECTIVE LINERS
 PE BETONSCHUTZPLATTENPP
 BETONSCHUTZPLATTENPP
 PE CONCRETE
 PROTECTIVE LINERS
 PEHD BIONIC SCS BETONSCHUTZPLATTEN
 PEHD BIONIC SCS BETONSCHUTZPLATTEN
 PEHD BIONIC SCS CONCRETE
 PEHD BIONIC SCS CONCRETE
 PE 80 / HDPE BLUE HYDRO-
 UND HYDROCLICK
 PE 80 / HDPE BLUE HYDRO-
 AND HYDROCLICK
 PE 100-EL ESD
 BETONSCHUTZPLATTEN
 PE 100-EL ESD CONCRETE
 PROTECTIVE LINERS
 PE 100-EL ESD
 BETONSCHUTZPLATTEN
 PE 100-EL ESD CONCRETE
 PROTECTIVE LINERS
 ECTFE BETONSCHUTZPLATTEN
 ECTFE BETONSCHUTZPLATTEN
 ECTFE CONCRETE
 PROTECTIVE LINERS
 INDUKTOFIX
 INDUKTOFIX
 SCHWEISSDRAHT
 WELDING-ROD

Schweisdraht 3kg Rolle Welding-Rod 3kg roll

Kreis-Querschnitt

circular profile

extrudiert

extruded

**Warmgas-
Ziehschweissung**

Hot-gas-welding

PE gelb RAL1003

PE yellow RAL1003

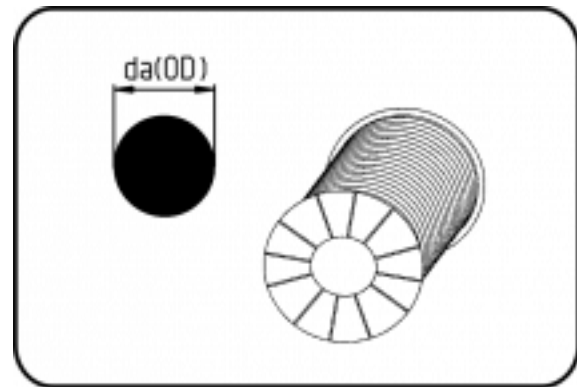

Code: 21.410

Dimension Dimension	Code Code	Detail Detail	da(OD) mm	Gewicht Weight
3	21.410.0000.30	3mm x min. 380m	3	1,00
4	21.410.0000.40	4mm x min. 220m	4	1,00

Schweisdraht 3kg Rolle Welding-Rod 3kg roll

Kreis-Querschnitt

circular profile

1 Jahr UV stabilisiert

1 year UV stabilized

extrudiert

extruded

**Warmgas-
Ziehschweissung**

Hot-gas-welding

PE achatgrau RAL7038

PE agate grey RAL7038

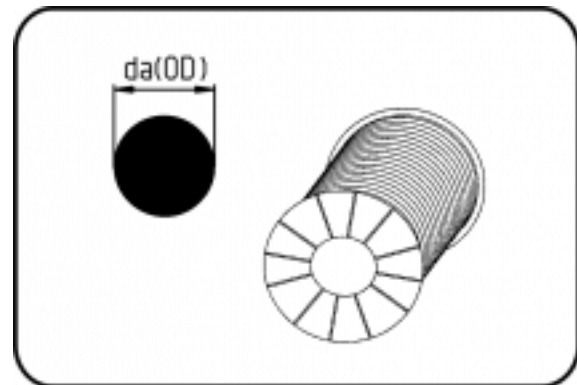

Code: 56.410

Dimension Dimension	Code Code	Detail Detail	da(OD) mm	Gewicht Weight
3	56.410.0000.30	3mm x min. 375m	3	1,00
4	56.410.0000.40	4mm x min. 220m	4	1,00

Schweisdraht 3kg Rolle Welding-Rod 3kg roll

Kreis-Querschnitt

circular profile

extrudiert

extruded

**Warmgas-
Ziehschweissung**

Hot-gas-welding

PE 100-el schwarz

PE 100-el black

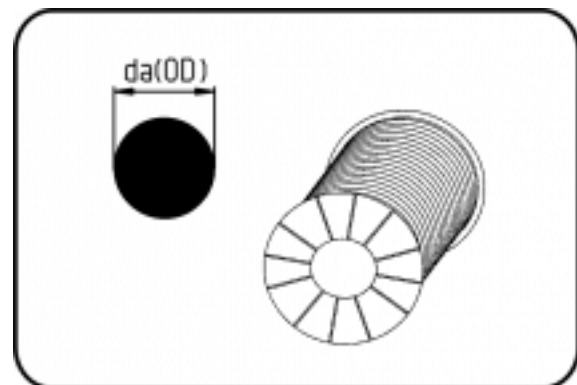

Code: 28.410

Dimension Dimension	Code Code	Detail Detail	da(OD) mm	Gewicht Weight
3	28.410.0000.30	3mm x min. 365m	3	1,00
4	28.410.0000.40	4mm x min. 211m	4	1,00

BETONSCHUTZPLATTEN PP CONCRETE PROTECTIVE LINERS
 PE CONCRETE PROTECTIVE LINERS
 PEHD BIONIC SCS BETONSCHEIPE 80 / PEHD BLAU HYDRO+ UND HYDROCLICK HDPE BIONIC SCS CONCRETE PE 80 / HDPE BLUE HYDRO+ PROTECTIVE LINERS AND HYDROCLICK
 PE 100-EL ESD BETONSCHUTZPLATTEN PE 100-EL ESD CONCRETE PROTECTIVE LINERS
 IECTFE BETONSCHUTZPLATTE N PVDF-FLEX CONCRETE ATTEN PVDF-FLEX CONCRETE PROTECTIVE LINERS
 INDUKTOFIX INDUKTOFIX
 SCHWEISSDRAHT WELDING-ROD

PE BETONSCHUTZPLATTENPP BETONSCHUTZPLATTEN
PP CONCRETE
PROTECTIVE LINERS

PE BETONSCHUTZPLATTENPP
PE CONCRETE
PROTECTIVE LINERS

PEHD BIONIC SCS BETONSCHUTZPLATTEN
PE 80 / PEHD BLAU HYDRO+
UND HYDROCLICK
HDPE BIONIC SCS CONCRETE PE 80 / HDPE BLAU HYDRO+
AND HYDROCLICK

PE 100-EL ESD
BETONSCHUTZPLATTEN
PE 100-EL ESD CONCRETE
PROTECTIVE LINERS

ECTFE BETONSCHUTZPLATTEN
PVDF-FLEX CONCRETE
PROTECTIVE LINERS

ECTFE BETONSCHUTZPLATTEN
N
ECTFE CONCRETE
PROTECTIVE LINERS

INDUKTOFIX
INDUKTOFIX

SCHWEISSDRAHT
WELDING-ROD

Schweisssdraht 2kg Rolle

Kreis-Querschnitt

extrudiert

**Warmgas-
Ziehschweissung**

PVDF-FLEX natur

Welding-Rod 2kg roll

circular profile

extruded

Hot-gas-welding

PVDF-FLEX natural

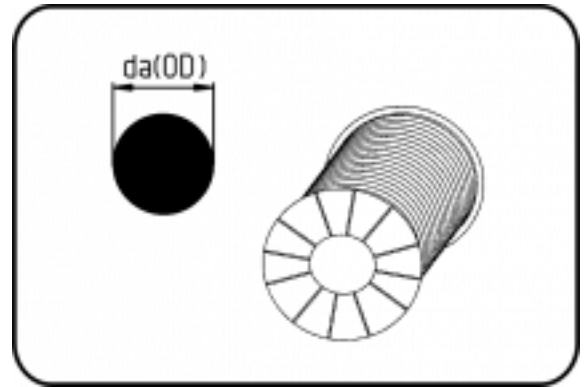

Code: 79.410

Dimension Dimension	Code Code	Detail Detail	da(OD) mm	Gewicht Weight
3	79.410.0000.30	3mm x min. 132m	3	1,00
4	79.410.0000.40	4mm x min. 77m	4	1,00

Schweisssdraht 2kg Rolle

Kreis-Querschnitt

extrudiert

**Warmgas-
Ziehschweissung**

ECTFE natur

Welding-Rod 2kg roll

circular profile

extruded

Hot-gas-welding

ECTFE natural

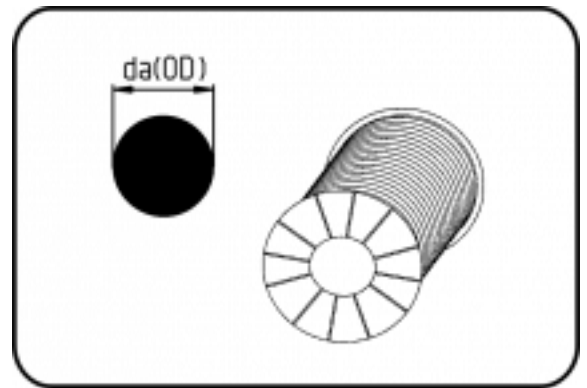

Code: 40.410

Dimension Dimension	Code Code	Detail Detail	da(OD) mm	Gewicht Weight
3	40.410.0000.30	3mm x min. 140m	3	1,00
4	40.410.0000.40	4mm x min. 81m	4	1,00

**Reinigungsdraht
f.Schweissextr.**

Kreis-Querschnitt / 2kg Rolle

extrudiert

Sonderpolymer

**Purging rod for Extrusion
Gun**

circular profile / 2kg roll

extruded

Special Polymer

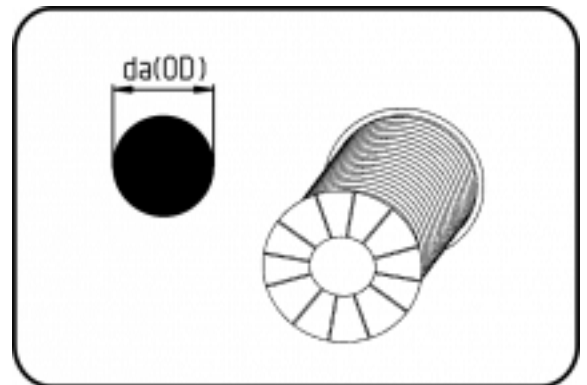

Code: 76.410

Dimension Dimension	Code Code	Detail Detail	da(OD) mm	Gewicht Weight
4	76.410.0000.40	4mm	4	1,00