

## Seal Clean Dichtungen

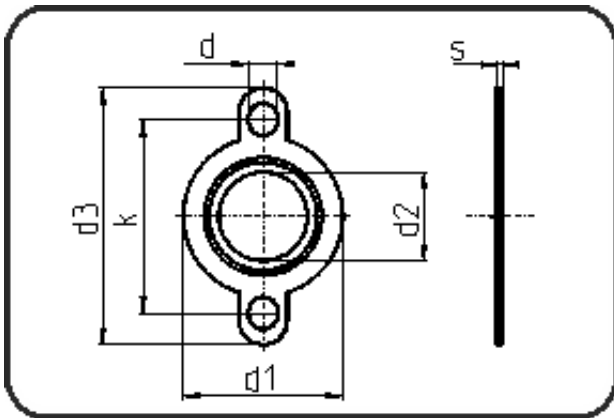

Code: 372.3

- Seal Clean Dichtung
- DIN
- für AGRU PE/PP Flansche
- Flanschverbindung
- ePTFE weiss

Dimension	Code	Detail	Gewicht
50	88.372.3050.11	50 - SDR11 DIN	0.01

	Einheit	Nominale	Tol+	Tol-
s	mm	3	0.50	0.50
d	mm	18	1.00	0.00
d1	mm	88	1.50	1.50
d3	mm	142	1.50	1.50
d2	mm	39,9	1.00	1.00
k	mm	110	1.00	1.00