

Kurzschenkelige Fittings

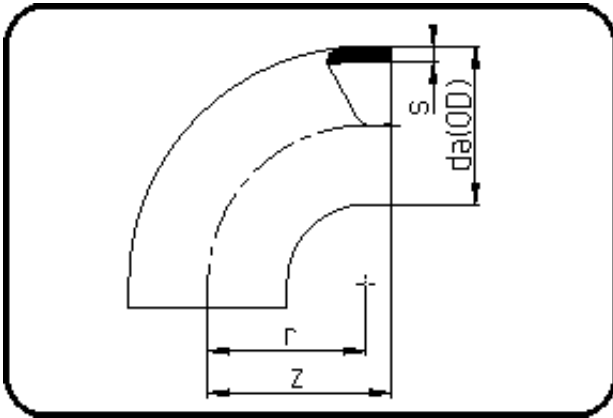

Code: 001

- Bogen 90°
- kurze Schenkel
- formgespritzt
- **Stumpfschweissung**
- **PE 100-RC schwarz**

Dimension	Code	Detail	Gewicht
40	70.001.0040.11	40X3,7 SDR11 ISO S-5	0.04

	Einheit	Nominale	Tol+	Tol-
da(OD)	mm	40	0.40	0.00
r	mm	40	0.00	0.00
s	mm	3,7	0.50	0.00
z	mm	50	3.00	3.00