

Kurzschenkelige Fittings

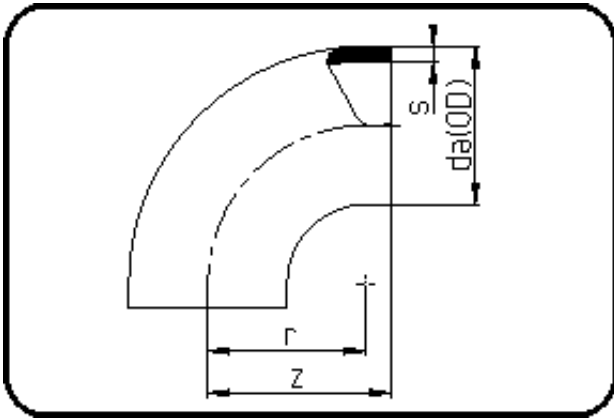

Code: 001

- Bogen 90°
- kurze Schenkel
- formgespritzt
- **Stumpfschweissung**
- **PE 100-RC schwarz**

Dimension	Code	Detail	Gewicht
90	70.001.0090.11	90X8,2 SDR11 ISO S-5	0.37

	Einheit	Nominale	Tol+	Tol-
da(OD)	mm	90	0.90	0.00
r	mm	90	0.00	0.00
s	mm	8,2	1.00	0.00
z	mm	100	3.00	3.00