

Kurzschenkelige Fittings

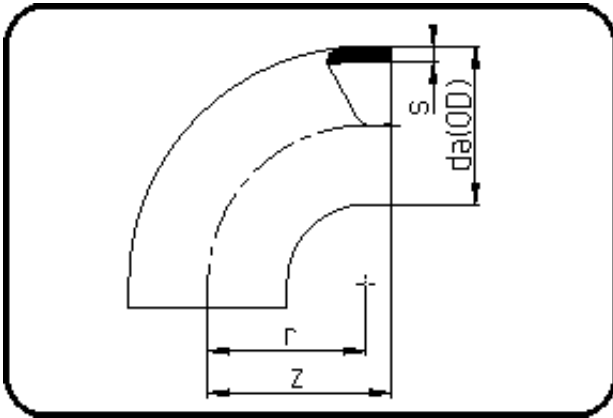

Code: 001

- Bogen 90°
- kurze Schenkel
- formgespritzt
- **Stumpfschweissung**
- **PE 100-RC schwarz**

Dimension	Code	Detail	Gewicht
250	70.001.0250.33	250X7,7 SDR33 ISO S-16	3.44

	Einheit	Nominale	Tol+	Tol-
da(OD)	mm	250	2.30	0.00
r	mm	265	0.00	0.00
s	mm	7,7	0.90	0.00
z	mm	290	6.00	6.00