

Muffenschweiss-Fittings

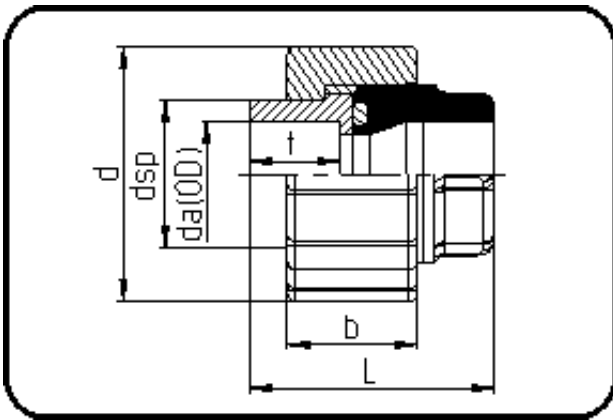

Code: 024.11

- Verschraubung Typ 24
- FPM-Dichtung
- formgespritzt
- **Muffenschweissung**
- **PE 100-RC schwarz**

Dimension	Code	Detail	Gewicht
25	70.024.1125.07	25 - MOP 16 bar	0.06

	Einheit	Nominale	Tol+	Tol-
da(OD)	mm	25	0.00	0.00
L	mm	49	3.00	3.00
b	mm	26	1.50	1.50
dsp	mm	35,7	1.00	1.00
d	mm	57	1.50	1.50
t	mm	18	1.50	1.50