

Muffenschweiss-Fittings

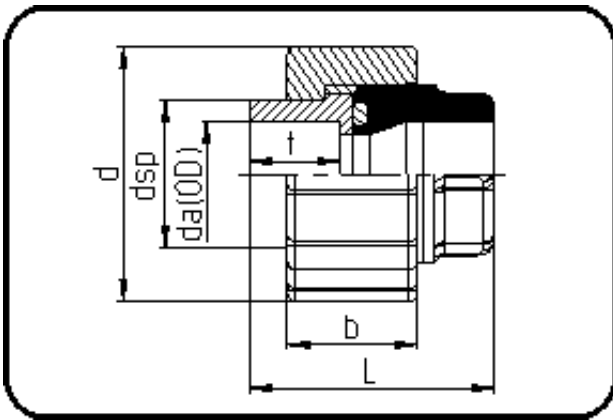

Code: 024.11

- Verschraubung Typ 24
- FPM-Dichtung
- formgespritzt
- **Muffenschweissung**
- **PE 100-RC schwarz**

Dimension	Code	Detail	Gewicht
40	70.024.1140.07	40 - MOP 16 bar	0.14

	Einheit	Nominale	Tol+	Tol-
da(OD)	mm	40	0.00	0.00
L	mm	59	3.00	3.00
b	mm	31	1.50	1.50
dsp	mm	52,8	1.00	1.00
d	mm	78	1.50	1.50
t	mm	22	1.50	1.50