

PE/PE Simultaneous Welding

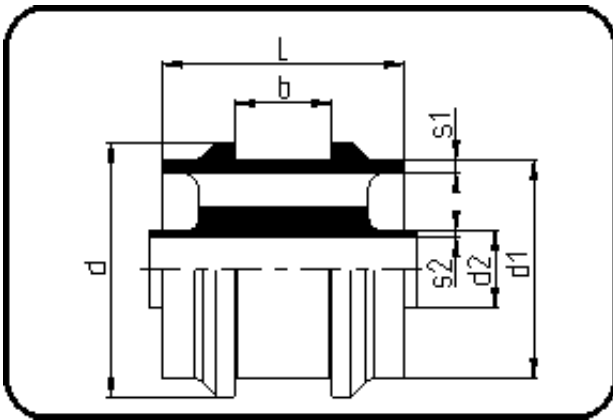

Code: 149

- Dog Bone Type II, Collar
- with cut out
- machined
- **Simultaneous-welding**
- PE 100-RC/PE 100-RC

Dimension	Code	Detail	Weight
160/90	82.149.1690.31	160/90 SDR33/11	1.75

	Unit	Nominale	Tol+	Tol-
L	mm	130	1.50	1.50
b	mm	60	1.50	0.00
d	mm	180	1.00	1.00
d1	mm	160	2.25	0.00
SDR2		11	0.00	0.00
SDR1		33	0.00	0.00
s2	mm	8,2	1.10	0.00
d2	mm	90	1.35	0.00
s1	mm	4,9	0.70	0.00