

PE/PVDF Staggered Welding

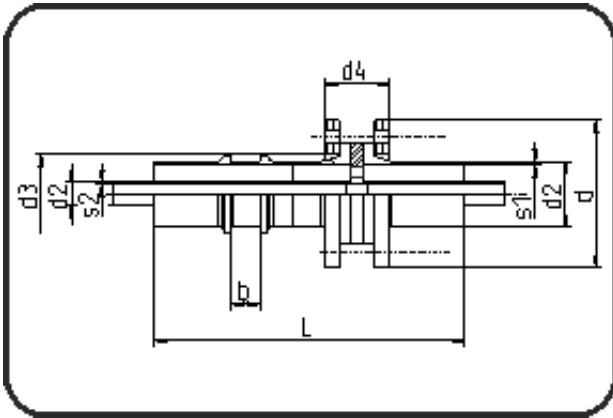

Code: 249

- Dog Bone Type III, Collar
- with cut out
- machined
- Staggered+E-fusion-welding
- HDPE/PVDF

Dimension	Code	Detail	Weight
90/32	84.249.9032.72	90/32 SDR17/21	4.05

	Unit	Nominale	Tol+	Tol-
L	mm	430	3.00	3.00
SDR2		21	0.00	0.00
SDR1		17	0.00	0.00
s2	mm	2,4	0.50	0.00
s1	mm	5,4	0.80	0.00
b	mm	40	43.00	40.00
numb	pc	8	0.00	0.00
d	mm	202	1.50	1.50
d1	mm	90	1.35	0.00
d3	mm	108	1.50	0.00
d2	mm	32	0.45	0.00
K	mm	M16	0.00	0.00
d4	mm	94	0.00	0.00