

PP/PP Simultaneous Welding

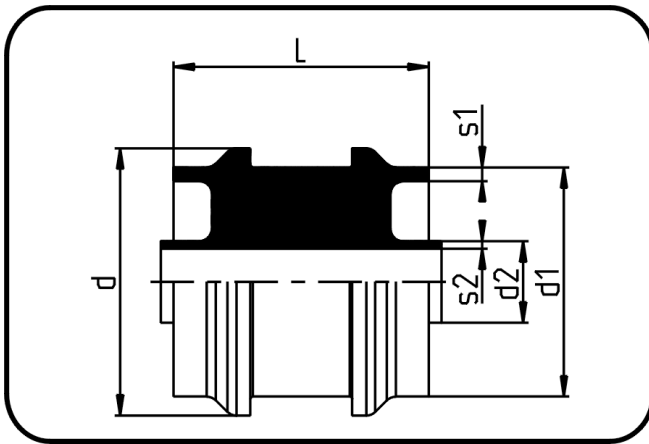

Code: 139

- Dog Bone Type II, Collar
- without cut out
- machined
- Simultaneous-welding
- PP/PP

Dimension	Code	Detail	L mm	s1 mm	s2 mm	d mm	d1 mm	d2 mm	Weight
160/90	80.139.1690.37	160/90 SDR33/17	130	4,9	5,4	180	160	90	1.20
160/90	80.139.1690.31	160/90 SDR33/11	130	4,9	8,2	180	160	90	1.40
280/160	80.139.2816.31	280/160 SDR33/11	161	8,6	14,6	305	280	160	4.37
315/200	80.139.3120.31	315/200 SDR33/11	166	9,7	18,2	340	315	200	5.43
355/250	80.139.3525.31	355/250 SDR33/11	166	10,9	22,8	380	355	250	6.78