

Elongated Fittings

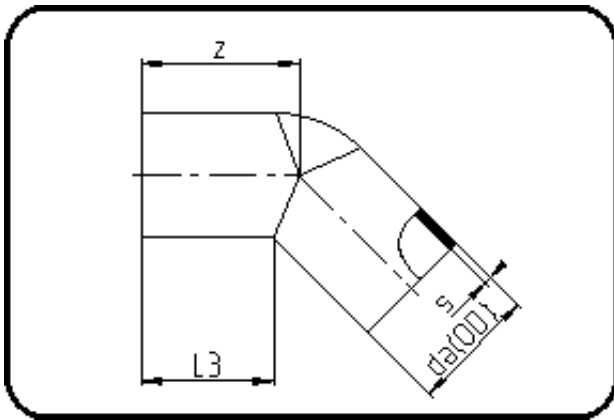

Code: 060

- Elbow 45°
- long spigot
- W/P-TW
- injection moulded
- **Butt + E-fusion-welding**
- PE 100-RC black

Dimension	Code	Detail	Weight
50	70.060.0050.11	50X4,6 SDR11 PN16	0.09

	Unit	Nominale	Tol+	Tol-
da(OD)	mm	50	0.40	0.00
L3	mm	57	1.50	1.50
s	mm	4,6	0.60	0.00
z	mm	66,5	1.50	1.50