

Elongated Fittings

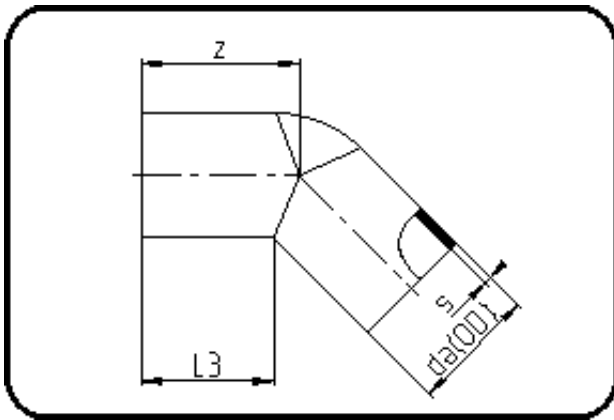

Code: 060

- Elbow 45°
- long spigot
- W/P-TW
- injection moulded
- **Butt + E-fusion-welding**
- PE 100-RC black

Dimension	Code	Detail	Weight
140	70.060.0140.17	140X8,3 SDR17 PN10	1.00

	Unit	Nominale	Tol+	Tol-
da(OD)	mm	140	0.90	0.00
L3	mm	99	2.25	2.25
s	mm	8,3	1.00	0.00
z	mm	129	2.25	2.25