

Saddles

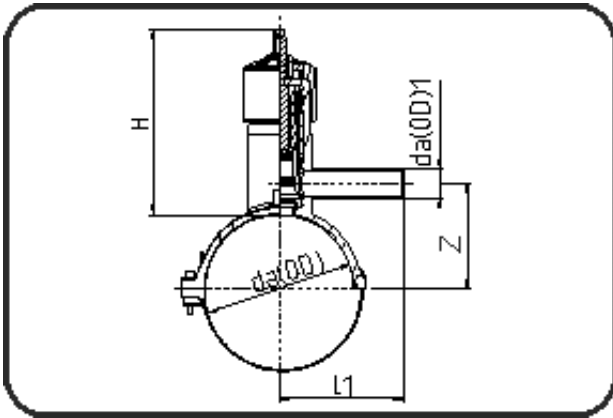

Code: 70.079

- **Pressure Tapping Valve**
- brass-valve+integrated cutter
- W/P-TW
- injection moulded
- **Electro-fusion**
- **PE 100-RC black**

For operating the pressure tapping valve an extension spindle is required.

Dimension	Code	Detail	Weight
315/63	70.079.3163.11	315/63 SDR 17 - 11 PN16	2.51

	Unit	Nominale	Tol+	Tol-
da(OD)	mm	315	0.50	0.00
L1	mm	192	1.50	1.50
h	mm	203	0.60	0.00
da1(OD1)	mm	63	0.40	0.00
z	mm	203,6	0.00	0.00